

CITY OF MINNEAPOLIS

Street Design Guide

February 2021

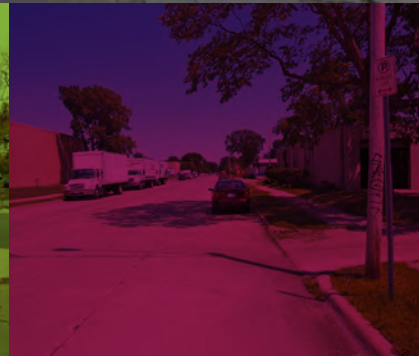
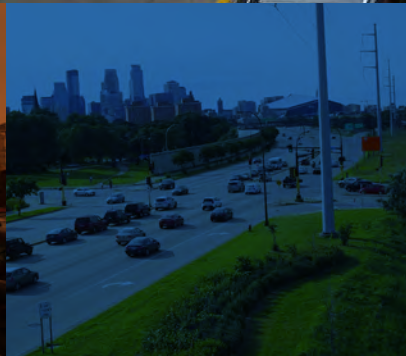

1.0 INTRODUCTION

- [1.1 Introduction & Purpose](#)
- [1.2 Policy Guidance](#)
- [1.3 Relationship to Other Standards & Guidance](#)
- [1.4 How to Use](#)

2.0 STREET TYPE GUIDANCE

- [2.1 Introduction](#)
- [2.2 Street Type Map](#)
- [2.3 Urban Neighborhood](#)
- [2.4 Urban Neighborhood Connectors](#)
- [2.5 Production and Processing](#)
- [2.6 Mixed Use Community Connectors](#)
- [2.7 Mixed Use Commercial Connectors](#)
- [2.8 Mixed Use Regional Connectors](#)
- [2.9 Downtown Core](#)
- [2.10 Parkways](#)
- [2.11 Trails](#)
- [2.12 Alley](#)

3.0 STREET DESIGN GUIDANCE

- [3.1 Introduction](#)
- [3.2 Sidewalks](#)
 - [3.2A Introduction and general guidance](#)
 - [3.2B Sidewalk zone design guidance](#)
 - [3.2C Sidewalk surface design](#)
- [3.3 Boulevards and furnishings](#)
 - [3.3A Introduction and general guidance](#)
 - [3.3B Curbs](#)
 - [3.3C Greening](#)
 - [3.3D Street Trees](#)
 - [3.3E Green Stormwater Infrastructure](#)
 - [3.3F Utilities and signs](#)
 - [3.3G Street lighting](#)
 - [3.3H Bicycle and micro mobility parking](#)
 - [3.3I Driveways](#)
 - [3.3J Sidewalk cafes](#)

[3.4 Bikeways](#)

- [3.4A Introduction and general guidance](#)
- [3.4B Protected bike lanes introduction](#)
- [3.4C Delineator-protected bike lanes](#)
- [3.4D Planter-protected bike lanes](#)
- [3.4E In-street curb-protected bike lanes](#)
- [3.4F Sidewalk-level protected bike lanes](#)
- [3.4G Shared use paths](#)
- [3.4H Neighborhood greenways](#)
- [3.4I Neighborhood greenways: full greenways](#)
- [3.4J Neighborhood greenways: bicycle boulevards](#)
- [3.4K Bike lanes, unprotected](#)
- [3.4L Buffered bike lanes, unprotected](#)
- [3.4M Contraflow bike lanes](#)
- [3.4N Advisory bike lanes](#)

[3.5 Transit stops](#)

- [3.5A Introduction and general guidance](#)
- [3.5B Regular-route bus stops](#)
- [3.5C Bus Rapid Transit stations](#)
- [3.5D Bus stops and bikeways](#)

[3.6 Roadways](#)

- [3.6A Introduction and general guidance](#)
- [3.6B Lane widths](#)
- [3.6C Design speed](#)
- [3.6D Traffic calming and speed management](#)
- [3.6E Bus-only lanes](#)
- [3.6F In-lane bus stops](#)
- [3.6G Vehicle parking and curbside uses](#)
- [3.6H Medians](#)
- [3.6I Historic streets](#)

[3.7 Intersections](#)

- [3.7A Introduction and general guidance](#)
- [3.7B Design and control vehicles](#)
- [3.7C Curb-return radii](#)
- [3.7D Pedestrian crossings](#)
- [3.7E Bikeway intersection design](#)
- [3.7F Traffic circles](#)



Minneapolis streets are the backbone of people's daily routines and we want to make sure they work for everyone, no matter your race, gender, or background, or how you choose to get around.

There are over 1,000 miles of streets in Minneapolis. Approximately 22% of the land area of the city is held in trust for the public within our streets (often called the public right of way). Streets include sidewalks, transit stops, bikeways, and roadway space. They provide space for trees and include critical infrastructure such as pipes for drinking water, stormwater drains to collect rain, and cables for electricity and communications. They are the common canvas for public art and community gathering places.

Minneapolis streets are the backbone of people's daily routines and we want to make sure they work for everyone, no matter your race, gender, or background, or how you choose to get around. This Street Design Guide seeks to support our streets as places for people and as an invaluable asset for broader outcomes of creating a more sustainable, equitable, safe, and prosperous city.

The City has adopted a [Climate Action Plan](#) (2013), [Complete Streets Policy](#) (2016), commitment to [Vision Zero](#) (2017), and [Transportation Action Plan](#) (2020), all of which take a fresh approach to thinking about how we design our streets and how street design can impact people's choices of how to travel. This Street Design Guide ensures that Minneapolis street design reflects these priorities.

1.1 PURPOSE

The Street Design Guide informs the planning and design of all future street projects in Minneapolis, including how the City will approach projects lead by partner agencies such as Hennepin County and the Minnesota Department of Transportation. The guide should also be used to inform adjustments in the street right of way in coordination with private development and utility work.

The guidance in this guide advances adopted City policy and supports the [goals of the Transportation Action Plan](#). This guide is a key step to make walking, bicycling, and transit real options for people of all backgrounds and in all neighborhoods of Minneapolis, eliminating all traffic deaths and severe injuries, and addressing the effects and lessening the causes of climate change.

The Street Design Guide replaces the Access Minneapolis Street and Sidewalk Design Guidelines.

The Transportation Action Plan provides the most direct guiding policy for the Street Design Guide, which includes [the strategy](#) to develop this guide.

The Street Design Guide will recognize streets as the city's largest public space and institutionalize the City's Transportation Action Plan, Complete Streets Policy, Vision Zero commitment, greenhouse gas emission reduction goal, commitment to racial justice, and stormwater management requirements through the design of the right of way.

The City of Minneapolis has strong policies that direct resources and set priorities relative to transportation. Key policies include:

Complete Streets, which establishes a modal priority framework that prioritizes people as they walk, bicycle, and take transit over people when they drive;

Goal of having 60% of trips taken by means other than a car by 2030 (walking, biking/ micromobility, or taking transit);

Vision Zero, which sets a goal of ending traffic related fatalities and life-changing injuries on our streets by 2027;

Commitment to racial justice, detailed in the City's Strategic Racial Equity Action Plan, which seeks to dismantle institutional injustice and close racial disparities in health, housing, public safety and economic opportunities; and

Climate-related goal to reduce citywide greenhouse gas emissions by 30% by 2025 and 80% by 2050 (from 2006 emissions levels), including goals to reduce transportation sector greenhouse gas emissions by more than 30% by 2030 (from 2018 levels);

Stormwater management programs that increase pervious areas and incorporate stormwater best management practices into linear projects to improve the water quality in the city's lakes, creeks and the Mississippi River.

These policies give clear direction for an approach to how we design our streets. Street design must reflect these policies and translate them into opportunities for increased health and safety outcomes for everyone and improved walking, biking, transit, and green infrastructure.

- Transportation Action Plan
- Minneapolis 2040 plan
- Accessibility regulations and guidance
- Complete Streets policy
- Vision Zero policy
- Strategic and Racial Equity Plan
- Stormwater management requirements

These policies give clear direction for an approach to how we design our streets. Street design must reflect these policies and translate them into opportunities for increased health and safety outcomes for everyone and improved walking, biking, transit, and green infrastructure.

TRANSPORTATION ACTION PLAN

The Minneapolis Transportation Action Plan is a 10-year action plan to guide future planning, design and implementation of transportation projects for all people in all the ways they move around. It was adopted by the City Council in December 2020. The Transportation Action Plan provides the most direct guiding policy for the Street Design Guide and is shaped by other important City policies such as Minneapolis 2040, the Climate Action Plan, Vision Zero, and Complete Streets.

The Transportation Action Plan seeks to unlock the potential of our streets as places for people and as an invaluable asset for broader outcomes achieved by making investments in our transportation network that work toward City goals.

The plan includes this [general vision for streets](#):

In 2030 our streets will reflect our City values. Our streets will be designed to address a climate emergency by emphasizing low or no carbon travel. Our streets will correct historic injustices in our transportation systems, because focusing on climate justice is focusing on racial justice. Our streets will add protection for people walking and bicycling and will be designed to prioritize an effective transit system that serves all trips. Our streets will be organized to enhance access to jobs. Though our streets will continue to serve car traffic, our future depends on our ability to increase the city's population as projected in Minneapolis 2040 without the car traffic associated with growth. This plan does not eliminate places for people to drive, it simply rebalances space to incentivize and allow for low carbon transportation options.

The Transportation Action Plan includes six goals that help guide transportation decisions by the City through 2030: climate, prosperity, safety, mobility, equity, and active partnerships (see Figure 1.2B).

The Transportation Action Plan includes a [Design for People topic](#) with strategies and actions to support the plan's six goals.

Figure 1.2B:

Transportation Action plan goals

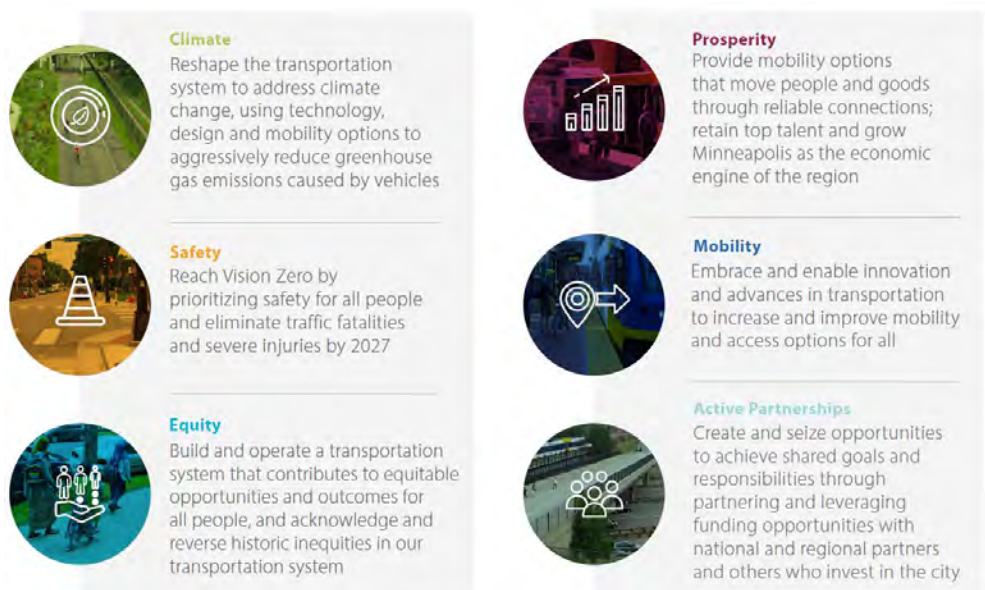

MINNEAPOLIS 2040 PLAN

Minneapolis 2040 is the City's Comprehensive Plan that shapes how the city will grow and change. The plan covers topics such as housing, job access, the design of new buildings, and how we use our streets. It was adopted by the City Council in December 2018.

The Transportation Action Plan is aligned with Minneapolis 2040 and provides additional transportation-focused detail to the vision, goals, and policies in Minneapolis 2040 (see Figure 1.2C).

The **Street Types** in this guide support the planned **land uses and built form** in Minneapolis 2040 and this guide is consistent with Minneapolis 2040.

Figure 1.2C:
Minneapolis 2040 transportation related themes

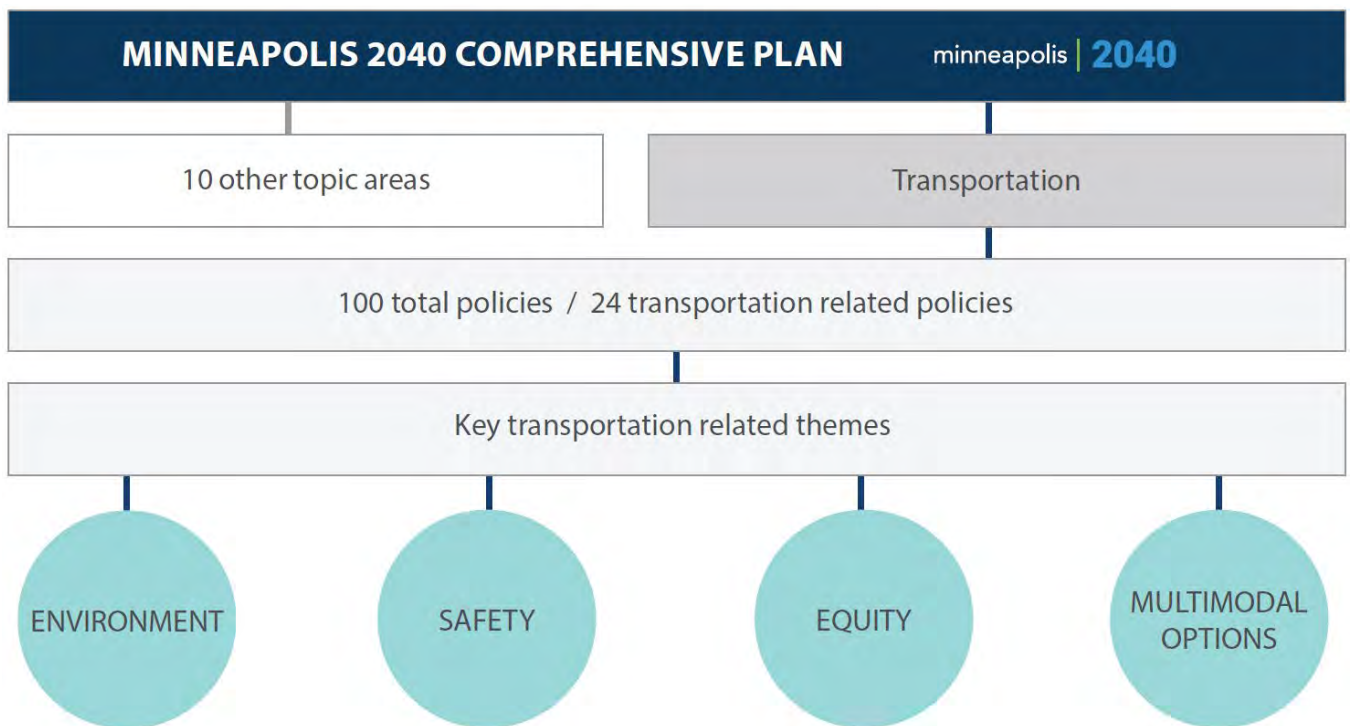

ACCESSIBILITY REGULATIONS AND GUIDANCE

Enacted in 1990, the Americans with Disabilities Act (ADA) prohibits discrimination on the basis of disability and mandates equal opportunity for individuals with disabilities. Title II of the ADA and Section 504 of the Rehabilitation Act of 1973 require state and local governments to provide pedestrian access for people with disabilities whenever a pedestrian facility exists in order for people with disabilities to equally access and benefit from an agency's programs, services and activities.

Private development projects, private and public utilities, contractors, and public agencies that impact the public right of way are required to maintain accessibility throughout construction activities and restore sidewalk, pedestrian curb ramps, street crossings, and traffic signal infrastructure and any other City-owned infrastructure so that the infrastructure complies with current ADA and City standards and functions as a complete system.

ADA compliance includes reconstruction of public sidewalks to at least the minimum dimensions established for the pedestrian accessible route (PAR, which is included as part of the pedestrian clear zone in the [sidewalk standards](#) of this guide), the reconstruction of impacted pedestrian ramps to current ADA standards, and the installation of Accessible Pedestrian Signal (APS) systems. Public Works often requires developers and designers to construct public sidewalks with widths beyond minimum ADA requirements to align with other goals and this guide. Developers, designers, and others working within the public right of way should refer to this Street Design Guide, [ADA Transition Plan for Public Works, Standard Supplemental Specifications for Construction of Public Infrastructure](#), and the following federal regulations for current standards and guidance.

Governing ADA Regulations and Guidance

The most recent ADA standard is the 2010 ADA Standards for Accessible Design, which sets the minimum requirements – both scoping and technical – for newly designed and constructed or altered State and local government facilities, public accommodations, and commercial facilities to be readily accessible to and usable by individuals with disabilities. It is effectuated from 28 CFR 35.151 and the 2004 Americans with Disabilities Act Accessibility Guidelines (ADAAG). The Federal Highway Administration (FHWA) and Department of Justice (DOJ) have recommended using the Proposed Guidelines for Pedestrian Facilities in the Public Right of way (PROWAG) for designing and constructing facilities within the public rights of way as a best practice for accessibility issues in the public right of way not covered by the Department of Justice’s or the Department of Transportation’s currently adopted standards. The Manual on Uniform Traffic Control Devices (MUTCD) is also incorporated by reference within PROWAG.

The City of Minneapolis follows the most recent [2010 ADA Standards for Accessible Design](#) and looks to [Proposed Guidelines for Pedestrian Facilities in the Public Right of way \(PROWAG\)](#) for guidance on how to supplement the 2010 ADA Standards. The Minneapolis Street Design Guide incorporates current standards and best practices, and seeks to establish guidance for designing and constructing projects in the public right of way in Minneapolis that exceed these standards and best practices.

ADA Transition Planning in the City of Minneapolis

The [ADA Action Plan](#) is the City’s comprehensive policy document that addresses citywide programs and services and fulfills the Title II legal requirements for local governments. The ADA Action Plan is supplemented by the [ADA Transition Plan for Public Works](#), which addresses Title II requirements and accessibility needs within the City of Minneapolis’ public right of way.

COMPLETE STREETS POLICY

The [Minneapolis Complete Streets](#) policy establishes a modal priority framework that prioritizes people as they walk, bicycle, and take transit over people when they drive (see Figure 1.2D). The policy was adopted by the City Council in 2016. The Complete Streets policy will be updated in 2021 to incorporate freight, micromobility, and green infrastructure.

The Street Design Guide follows the Complete Streets policy. This Street Design Guide will be updated in 2021 as needed to reflect the updated Complete Streets policy, although guidance is aligned with the likely updates to the policy.

Figure 1.2D:

Complete Streets modal priority framework



VISION ZERO POLICY

[Vision Zero](#) is the City's commitment to eliminate traffic deaths and severe injuries on City streets by 2027. The City Council adopted the [Vision Zero resolution](#) in 2017 and adopted the [2020-2022 Vision Zero Action Plan](#) in December 2019.

The loss of human life in traffic deaths on our streets is unacceptable. The City is committed to ending death and life-altering injuries on our streets. We will work with urgency to implement Vision Zero as one death on our streets is one too many.

Vision Zero takes a systematic approach to traffic safety that coordinates efforts across engineering, public safety, health, and community outreach and uses the best available data. Vision Zero recognizes that humans will make mistakes, but that we need to design safe systems so that individual mistakes do not lead to death or severe injuries.

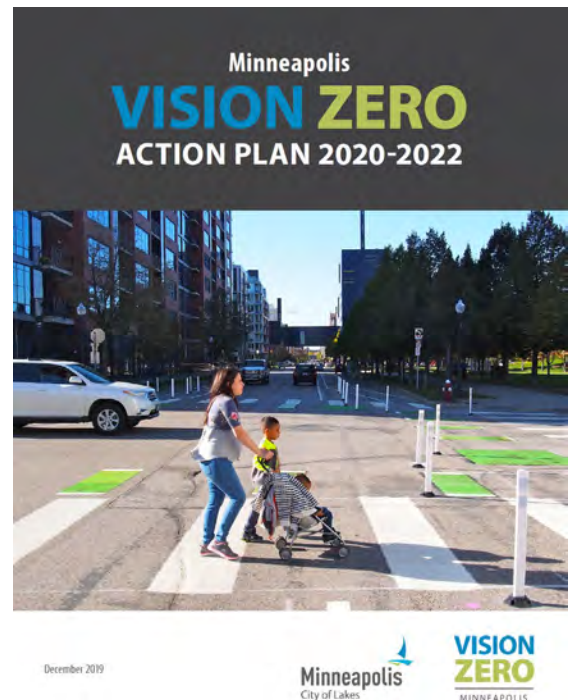

STRATEGIC AND RACIAL EQUITY ACTION PLAN

The [Strategic and Racial Equity Action Plan](#) identifies a set of operational and policy priorities that the City commits to significantly and sustainably improve through 2022. The plan was adopted by the City Council in September 2019.

Despite Minneapolis' reputation as one of the most progressive, thriving cities in the country, it's marked by some of the worst racial disparities of all major American cities. Across the board, from housing and education to employment and income, significant and persistent gaps exist between white residents and Black, Indigenous and People of Color (BIPOC) residents.

The Strategic and Racial Equity Action Plan includes this Vision:

Minneapolis is an intentionally compassionate city where each of us can reach our full potential while caring for one another, eliminating racial disparities, improving our environment and promoting social well-being. We lead in innovative and creative ways, focused not only on our present needs, but also the success of future generations.

The plan identifies citywide goals. One of those goals is directly important for the Street Design Guide and is reflected throughout this guide:

Built Environment & Transportation:
The City prioritizes high quality neighborhoods, streets, infrastructure and equitable access to multimodal transportation in all parts of the City through thoughtful planning and design.

STORMWATER MANAGEMENT REQUIREMENTS

Surface water resources, parks, and open spaces are distinctive features of the City of Minneapolis and part of its identity. The City takes a proactive approach to managing its water resources and infrastructure, recognizing that the health and vitality of the lakes and urban streams are linked to how property and storm and sanitary sewer systems are managed.

City, watershed, and state regulations guide management of stormwater runoff to protect water quality and mitigate flooding concerns. The Street Design Guide works to add additional pervious surface and green stormwater infrastructure to reduce harmful runoff and flooding, to meet water quality goals, and to mitigate the stress of impervious surfaces on the stormwater system. Increasing green infrastructure also provides additional benefits that align with the City's goals for climate, safety, equity, and Complete Streets.

Some pertinent local stormwater management requirements and guidance include:

- [City of Minneapolis Stormwater and Sanitary Guide](#)
- [Minneapolis Ordinance Chapter 54 - Storm Water Management](#)
- [Minnesota Pollution Control Agency \(MPCA\) National Pollutant Discharge Elimination System \(NPDES\) Construction Stormwater Permit - MNR100001](#)
- [Minnesota Stormwater Manual](#)

Local Watershed Requirements

- [Minnehaha Creek Watershed District](#)
- [Mississippi Watershed Management Organization](#)
- [Shingle Creek Watershed Management Commission](#)
- [Bassett Creek Watershed Management Commission](#)

1.3 Relationship to Other Standards and Guidance

The Street Design Guide provides Minneapolis-focused guidance that builds on state and national standards and guidance. The Street Design Guide focuses on information to inform development of a basic street layout. The City’s [Standard Specifications and Detail Plates](#) offer much more information to guide detailed design.

The Street Design Guide is not a standard and does not hold the same weight as state or federal standards. Generally, the Street Design Guide is aligned with relevant standards, although there are times when a variance, design exception, or request for experimentation will be required. Common instances when a variance is required are noted in the Street Design Guide.

Important standards include:

Minnesota [Local State Aid Rules](#), which govern streets on the State-Aid system.

[Minnesota Manual on Uniform Traffic Control Devices](#), which includes standards for traffic control devices along all roadways in the state.

In the creation of this guide, we have regularly used [guidance from the National Association of City Transportation Officials](#) as well as guidance from the Minnesota Department of Transportation. In some cases, we refer to them or other guides for additional details.

The Street Design Guide is broken into two interconnected sections:

[Street Types Guidance](#), which provides guidance organized by ten street types; and

[Street Design Guidance](#), which provides additional detailed guidance organized by six street zones:

[Sidewalks](#)

[Boulevards and Furnishings](#)

[Bikeways](#)

[Transit Stops](#)

[Roadways](#)

[Intersections](#)

GET STARTED



[Check out the street type map](#)

If you know your project location and want to know the street type



[Learn about our street types](#)

If you know your street type and want to find more details



[Explore the design guide](#)

If you're looking for details on specific street elements

The Street Design Guide informs the planning and design of all future street projects in Minneapolis, including street reconstructions and street retrofit projects. The Street Design Guide also informs how the City will approach street projects led by partner agencies such as Hennepin County and the Minnesota Department of Transportation. The guide should also be used to inform adjustments in the street right of way in coordination with private development and utility work.

The guidance in this guide advances adopted City policy and supports the goals of the Transportation Action Plan. This guide is a key step to make walking, bicycling, and transit real options for people of all backgrounds and in all neighborhoods of Minneapolis, eliminating all traffic deaths and severe injuries, and addressing the effects and lessening the causes of climate change.

When managing a street design project on an individual street, designers are encouraged to use the [Street Types map](#) to find guiding information about the street, including its street type, basic information, and modal network. They can then look to the guidance for the appropriate street type as a starting point for the design process. The Street Design Guide is intended to inform all projects, but each project has unique characteristics that impact final design decisions.

2.1 Introduction

This chapter includes design guidance organized around a set of street types, which are assigned to all streets in Minneapolis except freeways (see the [street types map](#)). The street types were developed based on the envisioned character of streets, including planned land uses and built form and street users and uses.

The street types recognize the range of conditions on streets within Minneapolis and classifies similar streets together to ensure consistent design practices that support City policies. The street types support the planned [land uses and built form](#) in the City's Comprehensive Plan, [Minneapolis 2040](#). Different land uses generate a range of trip types, varying numbers of trips, and require unique types of access for people and vehicles. The concept of a city-based street typology and the development of these street types is consistent with [guidance](#) from the National Association for City Transportation Officials (NACTO).

STREET TYPES

The Street Design Guide includes ten street types:



In addition to the street types, there are overlays and modal networks assigned to specific street segments that influence street design. Prior to designing a capital or private development project, designers should confirm overlays and modal networks by referencing the [street type map](#).

OVERLAYS

Jurisdiction

Jurisdiction identifies the decision-making body for the street segment. Common jurisdictions include the City of Minneapolis, Hennepin County, Minnesota Department of Transportation, Minneapolis Park and Recreation Board (MPRB), and University of Minnesota (U of M). In some cases, operations and maintenance responsibilities are delegated from the agency with jurisdictional control to another agency by agreement. Designers should consult maintenance agreements to understand existing responsibilities, and the staff whom negotiate them to check for any likelihood of responsibilities shifting in the near future.

Route

Route identifies the appropriate standards required by funding authorities for design, maintenance, or operation of the street. Common route types include Local, Municipal State Aid, County State Aid Highway, and State Trunk Highway. Designers should consult appropriate design standards and rules for the route type, but should be aware that some design standards are not as ideal for a highly-developed urban area like Minneapolis. If the rules conflict with the guidance in the City of Minneapolis Street Design Guide, designers should evaluate the conflicting guidance and consider seeking a variance or design exception with the appropriate jurisdiction. An understanding of appropriate design standards is important to understand early in the design process, as the application process for variances and design exceptions may influence project schedules.

Function Classification

Functional classification identifies the role that a street plays in the regional transportation system. The functional classification system is managed by the Metropolitan Council in accordance with Minnesota Department of Transportation and Federal Highway Administration standards. For designers, the functional classification is most relevant to consider when seeking and utilizing federal funding. Functional classifications include: principal arterials, minor arterials, collectors, and local streets.

Snow Emergency Route

Snow Emergencies are a set of predefined parking regulations that allow crews to completely clear streets of accumulating snow. In order to be plowed completely, streets must be free of parked vehicles. Snow Emergency Routes are streets where the roadway zone is prioritized for snow and ice control after significant winter storm events.

Historic Streets

Historic streets are specifically designated streets that may still retain some level of historic character, original historic brick, or cobble paving, or streets that have been reconstructed in more recent times with original or modern pavers to reflect a historic character. Designers should consider the historical character and material choices on historic streets. See [historic streets guidance](#) for more details.

Speed Limits

Speed limits regulate the maximum speed motor vehicles are allowed to operate to support safety and access. Designers should design streets in a way that supports travel at or below the speed limit. The guidance by street type was created with that goal in mind recognizing that most streets need traffic calming elements to support safe speeds.

MODAL NETWORKS

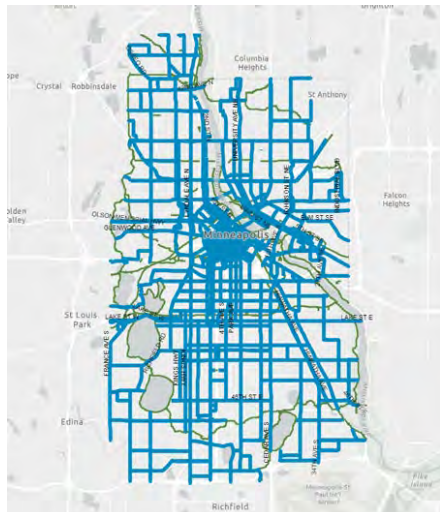

Pedestrian Priority Network

The [Pedestrian Priority Network](#) is a grid of streets that represent where people most frequently walk and often includes access to transit and commercial and regional destinations. The Pedestrian Priority Network is the focus of planning, design, operations, and maintenance to improve the ease, comfort, and safety of people walking throughout the year. Streets on the Pedestrian Priority Network should typically include wider pedestrian zones, frequent high-quality pedestrian crossings, and more pedestrian-oriented street amenities. Streets not on the Pedestrian Priority Network should be designed with pedestrian needs in mind in accordance with the Complete Streets Policy. The Pedestrian Priority Network most commonly overlaps with Downtown Core, Mixed Use Commercial Connector, Mixed Use Community Connector, Mixed Use Regional Connector, and Urban Neighborhood Connector streets.

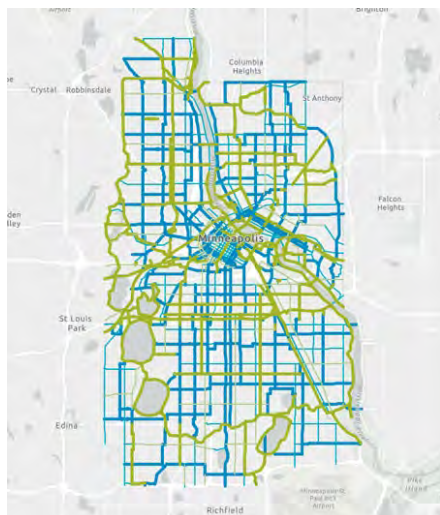

All Ages and Abilities Bikeway Network

The [All Ages and Abilities bikeway network](#) includes facilities for bicycle and micromobility traffic, including trails, protected bike lanes, and neighborhood greenways. Designers should include an All Ages and Ability bikeway in the design of any street on the network. Designers should evaluate the appropriate bikeway design if the street is not on the All Ages and Abilities Network; bikeways may be included on streets not on the network based on local context, needs, development opportunities, and changing transportation demands. The All Ages and Abilities Network overlaps with nearly all street types.

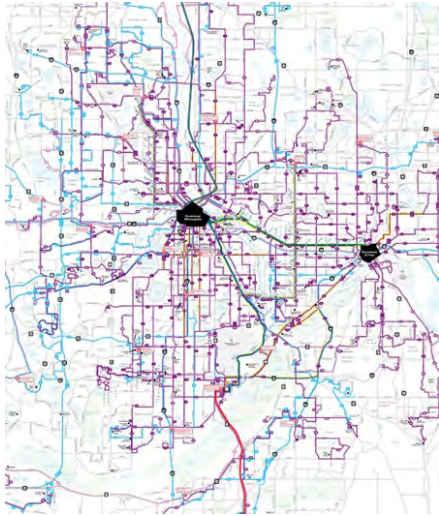

Transit routes

The [transit system map](#) includes streets where regular route transit occurs, including local bus, express bus, bus rapid transit, and light rail transit routes. Designers should follow [transit stop guidance](#) and appropriate lane width guidance for any street with transit service. The transit system most commonly overlaps with Downtown Core, Mixed Use Commercial Connector, Mixed Use Community Connector, Mixed Use Regional Connector, and Urban Neighborhood Connector streets.

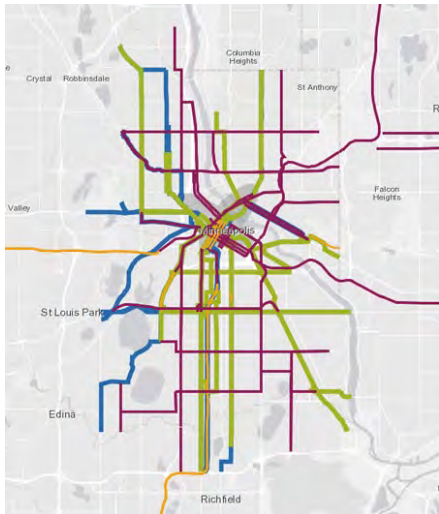

Transit Priority Projects

[Transit Priority Projects](#) identifies corridors to improve frequency and reliability on existing routes and identifies where new services are needed. Designers should consider planned future upgrades to transit service such as arterial bus rapid transit or bus-only lanes. Transit Priority Projects most commonly overlaps with Downtown Core, Mixed Use Commercial Connector, and Mixed Use Regional Connector streets.

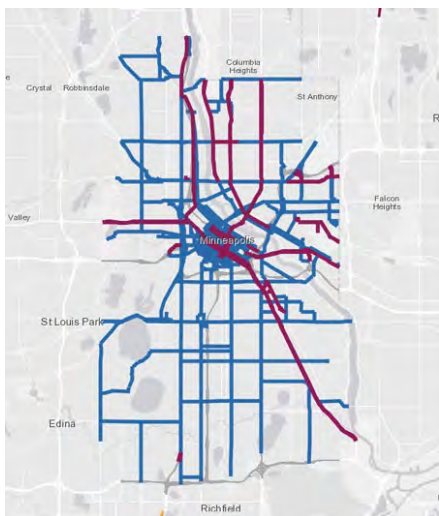

Truck Route Network

The [Truck Route Network](#) includes streets where large trucks are encouraged to operate between the interstate system and local destinations. [Per City ordinance](#), large trucks may operate on non-Truck Route streets for the shortest possible distance to access local destinations. Designers should follow appropriate [design vehicle guidance](#) for streets on the Truck Route Network. The Truck Route Network most commonly overlaps with Mixed Use Regional Connector, Mixed Use Commercial Connector, and Downtown Core streets.

INTRODUCTION

In this chapter, each street type includes a description, typical characteristics, typical design and operational features, typical concepts, and links to design guidance. The concepts reflect existing right of way widths commonly found in Minneapolis and are intended to inform project concepts and preliminary designs. The typical concepts support the City's Complete Streets Policy, Vision Zero commitment, greenhouse gas emission reduction goal, mode shift goal, commitment to racial justice, and stormwater management requirements. Where applicable, they include specific modal features, such as bikeways and transit lanes, and operational alternatives, such as one-way and two-way roadway options.

The typical concepts reflect a fully reconstructed street and are not intended for smaller scale street retrofit projects. The [street design guidance](#) outlines more details to inform street retrofit projects. Typical concepts do not reflect exact conditions and are not intended to be used for construction. Street character, modal networks, right of way width, and topography vary across the same street type and preexisting conditions (e.g. encroachments) may limit use of the full right of way. Evaluating concepts must follow a decision-making process consistent with the City's Complete Streets Policy – prioritizing people as they walk, bicycle, and take transit over people when they drive.

STREET ZONES

Design guidance for each street type is organized by zones (see Figure 2.1A.1):

- sidewalk zone, which includes frontage, clear, boulevard, and furnishing;

- bikeway zone, which may be in the roadway or adjacent to pedestrian zone; and

- roadway zone, which includes travel lanes, parking and loading/unloading lanes, curb and gutter, and medians.

The zones provide distinct spaces where similar street users and uses typically gather, move, or operate and provide a critical framework for design guidance. The typical concepts for each street type include dimensions for each zone to inform project concepts and preliminary design. The width and uses of the zones may change along a street segment or vary by time of day based on land use context and demands. For example, the loading zone may change to a curb extension at an intersection or a parking lane may change to a transit only lane during peak periods.

Figure 2.1A.1

Street Zones

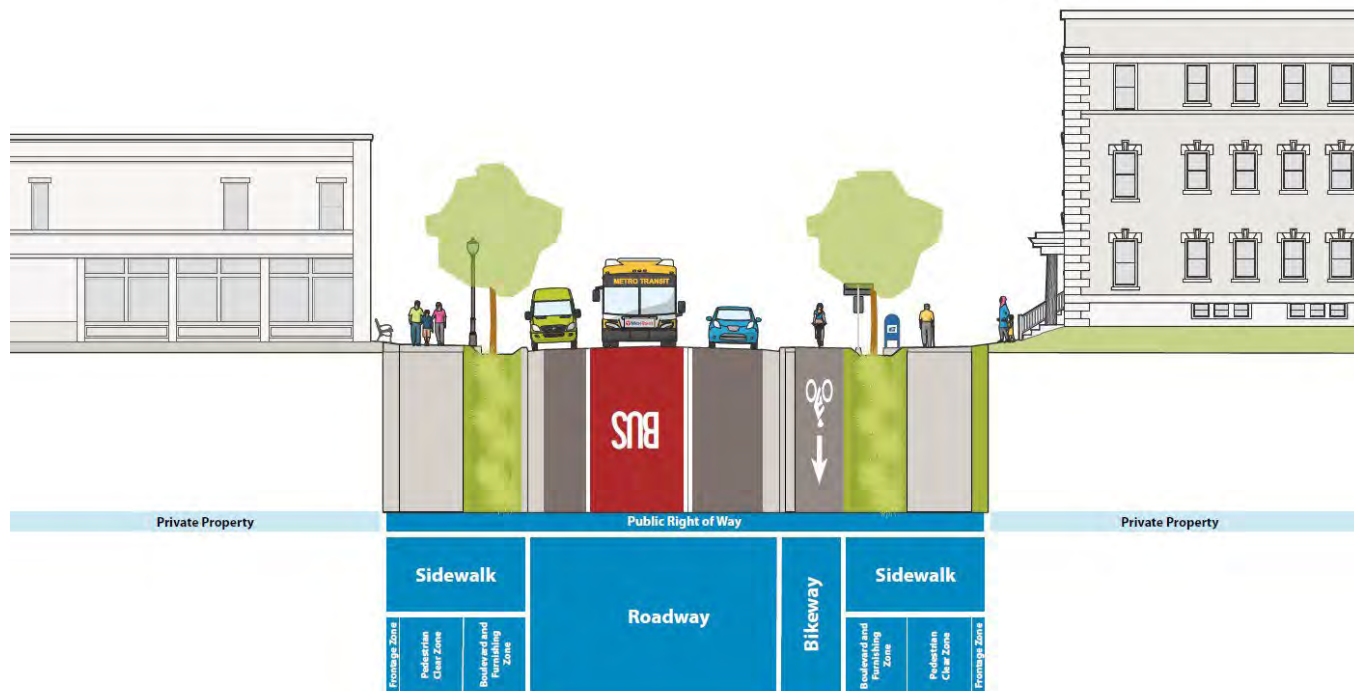

Sidewalk

The sidewalk zone is typically located directly adjacent to the edge of the public right of way. Sidewalks serve as the backbone of the pedestrian network and support access between private property and streets. Sidewalks are for people to walk or gather. Bicycles may legally use the sidewalk zone in limited locations outside of business districts. Motor vehicles also may need to travel across the sidewalk zone to access private property via driveways or alleys. The sidewalk zone is divided into three subzones: frontage, pedestrian clear, and boulevard and furnishing.

Frontage

The frontage zone is located immediately adjacent to the edge of the public right of way. This zone provides space for street users to access land uses and serves as a buffer between the pedestrian clear zone and buildings, structures, or elevation changes. Potential uses in the frontage zone include landscaping, transit shelters, retail displays, sidewalk cafes, or other features that make the pedestrian environment more usable, comfortable, and attractive. Along streets with commercial uses, consideration should be given to space for sidewalk cafes in the frontage zone in accordance with [Process and Criteria for Sidewalk Café Licenses](#).

Pedestrian Clear

The pedestrian clear zone is located between the frontage zone and boulevard and furnishing zone. This zone provides space for pedestrians to travel along streets and must be kept clear of obstructions, vertical discontinuities (e.g. manhole or utility covers that protrude up), slippery surfaces (e.g. tree

grates or other slick metal), and non-compliant cross slopes. The pedestrian clear zone serves as the Pedestrian Access Route, as defined by the Americans with Disability Act of 1990. The Pedestrian Access Route ensures a minimum passable space for those using mobility devices such as wheelchairs and provides predictability for those using other devices such as canes.

Boulevard and Furnishing

The boulevard and furnishing zone is located between the pedestrian clear zone and roadway or bikeway zone. This zone provides space for many activities: space for pedestrians to gather or wait for transit, street trees, landscaping, green stormwater infrastructure, furnishings, sidewalk cafes, signs, wayfinding, street lights, street signal infrastructure, utility cabinets, bicycle and scooter parking, charging stations for electric vehicles, and the curb. This zone also provides separation from people walking and motor vehicles.

Bikeway

The bikeway zone is typically located between the sidewalk zone and roadway zone. Unprotected bike lanes are typically located in the roadway zone. The bikeway zone provides space for people riding bicycles and low-powered vehicles to travel along streets and must be kept clear of obstructions. The bikeway zone may include buffers that overlap with the boulevard and furnishing zone.

Roadway

The roadway zone is typically located in the center of the right of way. This zone provides space for people traveling in transit or motor vehicles. People riding bicycles and micromobility also share this space in many locations. The edges of this zone often provide space for motor vehicle parking, stopping buses, loading and unloading, or parklets and bicycle corrals. Gutters and catch basins are also included at the edge of the roadway zone; they provide critical space for conveyance of stormwater and are generally not considered functional travel space for vehicles. The roadway may contain multiple marked or unmarked travel and parking lanes, including special use lanes like turn lanes or transit-only lanes. The roadway zone is used by all street users to cross intersecting streets and may be used exclusively by non-motorized users during events. Trails and some concepts for Urban Neighborhood streets do not include conventional roadway zones that maintain space for motor vehicles.

ENCROACHMENTS

Effective right of way space is important to understand early in the design process. Designers should consider how topography, adjacent land uses, and built form on private property interface with the public right of way. Actual right of way width and effective right of way can vary significantly due to permitted and non-permitted encroachments, such as existing buildings, retaining walls, staircases, doorways, areaways, and greening. Furthermore, it may not be practical or feasible to remove encroachments because of factors such as significant topography, historical preservation, impacts to structures, or project cost. If encroachments cannot be removed, the effective space to design may be more constrained than the actual right of way.

NEW STREETS

Street types are assigned to all existing and known planned street segments in Minneapolis. If new street segments are proposed to be constructed, the City of Minneapolis Public Works Department will evaluate the proposed location and assign one of the street types based on the planned land uses and built form, typical characteristics, and anticipated uses. To support the City's greenhouse gas reduction goals, streets that limit or prohibit motor vehicle access should be prioritized over streets that provide greater capacity for motor vehicles. After a new street is constructed, the street type map will be updated accordingly.

2.2 Street Type Map

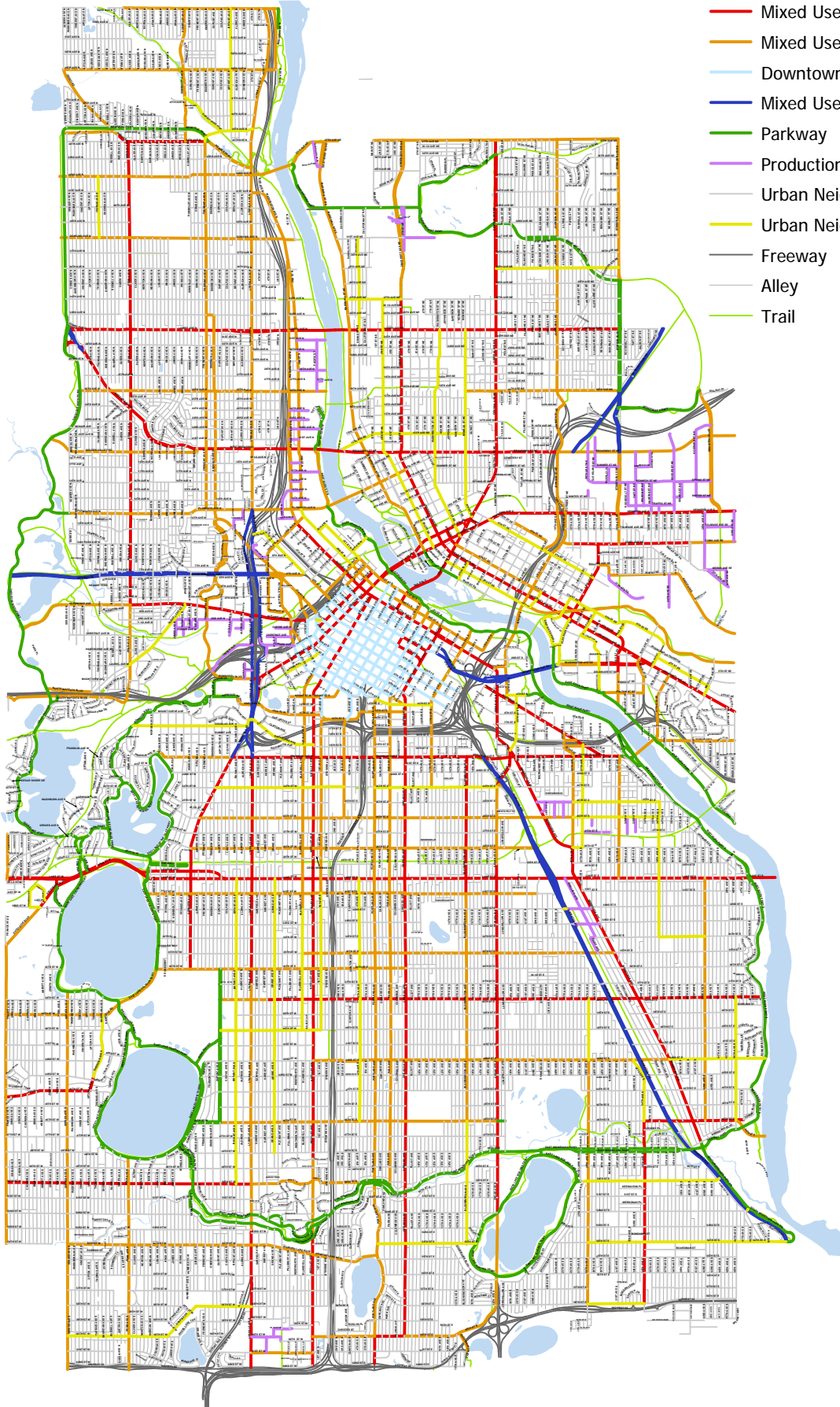

Street Types

- Mixed Use Commercial Connector
- Mixed Use Community Connector
- Downtown Core
- Mixed Use Regional Connector
- Parkway
- Production and Processing
- Urban Neighborhood
- Urban Neighborhood Connector
- Freeway
- Alley
- Trail





Local residential streets with low traffic volumes that provide access to residences, parks, and schools.

DESCRIPTION

Urban Neighborhood streets are local residential streets with low traffic volumes (typically lower than 1,500 average daily traffic) and that provide access to residences, parks, and schools. Urban Neighborhood streets are the most predominant street type in the city. Urban Neighborhood streets are not intended for through motor vehicle trips.

Examples include Russell Avenue North, Buchanan Street Northeast, and 43rd Street.

TYPICAL CHARACTERISTICS

Miles	~720 miles Approximately 65% of total street centerline mileage
Right of Way Width	Most commonly 60' with some 66', 80', and other widths
Effective Right of Way	Varies; most commonly 55'
Functional Class	Local
Jurisdiction	City of Minneapolis
Route	<ul style="list-style-type: none"> Local Municipal State Aid (limited number)
Modal Network	<ul style="list-style-type: none"> Pedestrian Priority Network (rarely) All Ages and Abilities Bikeway Network (some)
Snow Emergency Route	Not typically
Historic Street	Includes a limited number of historic streets

TYPICAL DESIGN AND OPERATIONS

See [Street Design Guidance chapter](#) for more information

A. Sidewalk	<ol style="list-style-type: none"> 1. 6' typical pedestrian clear width 2. 2'+ frontage width to any obstructions <p>See sidewalks guidance for more details.</p>
B. Boulevard and Furnishing	<ol style="list-style-type: none"> 1. 5'+ typical width (6'+ when possible), including 8" wide curb 2. Wider boulevard and furnishing zones should be used when feasible to support features that make the pedestrian environment more attractive and comfortable, support street tree health, and maximize green stormwater infrastructure. <p>See boulevards and furnishings guidance for more details.</p>
C. Bikeway	<p>For streets on the All Ages and Abilities bikeway network, neighborhood greenways should be used (either full greenway or bicycle boulevard, depending on context).</p>
D. Transit	<p>Very few streets include limited local bus service, typically to access route layover locations. Where regular local bus service exists or is planned, consider widening the roadway by approximately 2' from typical widths to support and see bus stops guidance. School buses typically use Urban Neighborhood streets and are reflected in guidance.</p>
E. Freight	<p>Not on the Truck Route Network, but local business access and deliveries are permitted.</p>

F. Roadway

1. The amount of motor vehicle parking should typically be right sized to target greater than 60% occupancy to reduce speeding and maximize greening. Streets will often combine sections of no parking, parking on both sides, and parking on one side to maximize greening and traffic calming. Extra consideration should be made to replace parking with expanded greening on “short block” Urban Neighborhood streets, which often have no or few properties directly fronting them.
2. 30' typical width for a two-way or one-way street with parking on both sides, including 2' gutters on each side
 - » For streets with greater than 75% average parking utilization, see [design guidance](#) for options to manage winter access.
3. 24' typical width for two-way street with parking on one side, including 2' gutters on each side
 - » For streets with greater than 75% average parking utilization, see [design guidance](#) for options to manage winter access.
4. 18' to 20' typical width for two-way street with no parking, including 2' gutters on each side
5. For blocks without parking on either side, generally include one or more 7' loading/unloading zone, which also provides space for winter passing zones. See [vehicle parking and curbside uses](#) guidance for more detail.
6. 18' to 20' typical width for one-way street with parking on one side, including 2' gutters on each side
 - » This configuration will most commonly be parried with a [neighborhood greenway](#), which provides additional space if needed for fire truck access. Designers should coordinate with the Fire department to ensure winter fire truck access.
 - » For streets with greater than 75% average parking utilization, see [design guidance](#) for options to manage winter access.
7. The roadway should include traffic calming features that reduce speed and limit through travel by motor vehicles. See [neighborhood traffic calming guidance](#) for more details.
8. One-way streets are generally discouraged unless connected with a [neighborhood greenway](#) because they can lead to more speeding.
9. Lane markings should not typically be included and users negotiate in a narrow, shared space.

G. Design speed

20 mph

See [design speed guidance](#) for more detail.

H. Design vehicle

Most commonly DL-23, but can also be SU-30 or WB-40 depending on intersecting street and context.

See [design and control vehicles guidance](#) for more details.

I. Control vehicle

Generally Aerial Fire Truck Mid Mount 100.

See [design and control vehicles guidance](#) for more details.

2.3 Urban Neighborhood

J. Motor Vehicle Property Access	<ol style="list-style-type: none"> 1. New driveways should be limited to locations without alley or cross street access. 2. Designers should explore removing driveways that are no longer being used, are no longer permitted, or where access is provided via an alley. Designers should also explore right-sizing driveway curb cuts. <p>See driveways guidance for more details.</p>
K. Intersection Traffic Control	<p>Stop control or yield control</p>
L. Intersection details	<ol style="list-style-type: none"> 1. Traffic circles should be considered for intersecting Urban Neighborhood streets. 2. Raised pedestrian crossings should generally be included across Urban Neighborhood streets when there is a high-volume pedestrian crossing (most typically along Mixed Use Commercial streets) or All Ages and Abilities bikeway network crossing.

TYPICAL CROSS SECTIONS

Figure 2.3.1

2-way Urban Neighborhood street with parking on both sides (55' effective right of way)



2.3 Urban Neighborhood

Figure 2.3.2

2-way Urban Neighborhood street with parking on one side (55' effective right of way)



2.3 Urban Neighborhood

Figure 2.3.3

2-way Urban Neighborhood street with no parking (55' effective right of way)

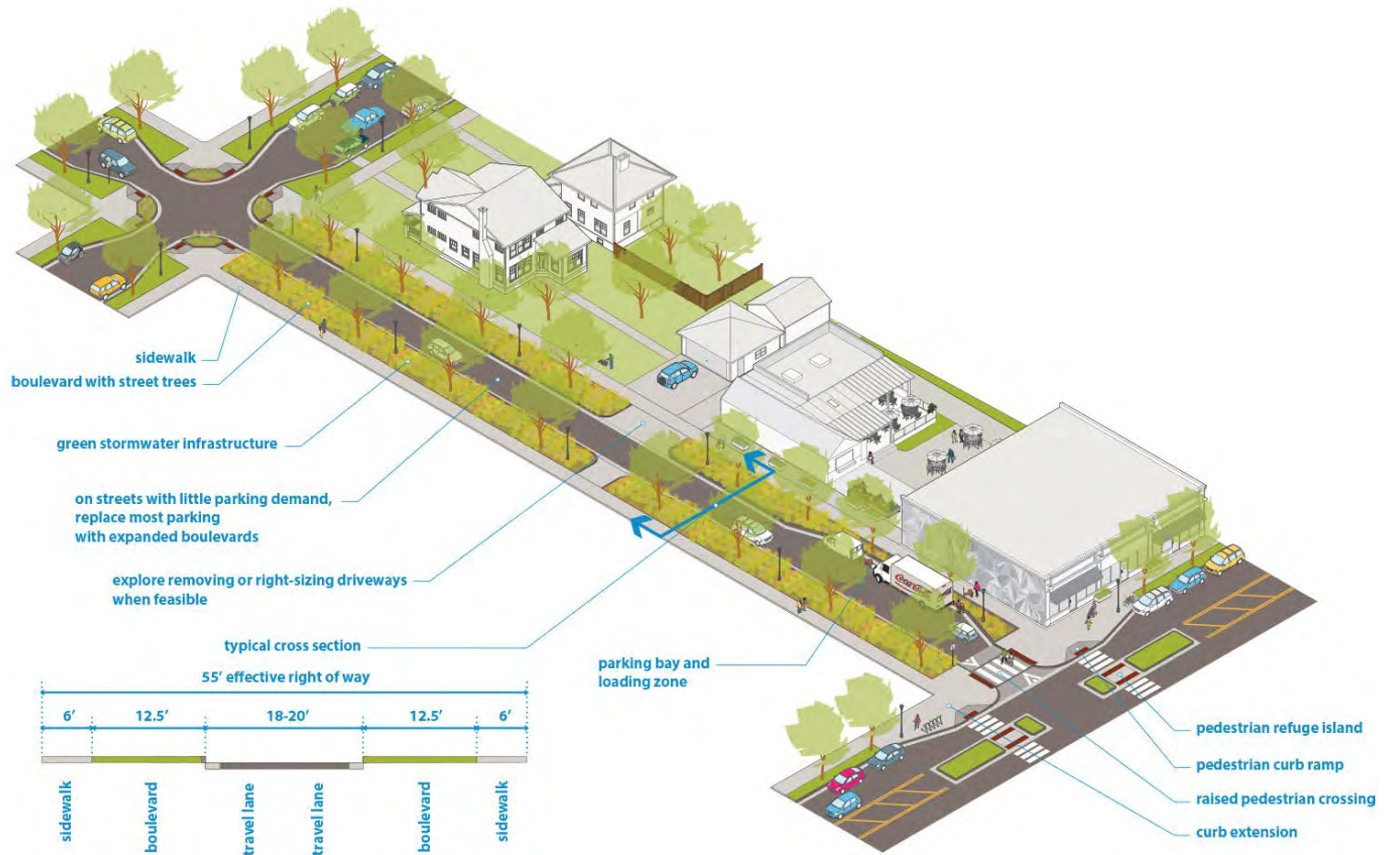

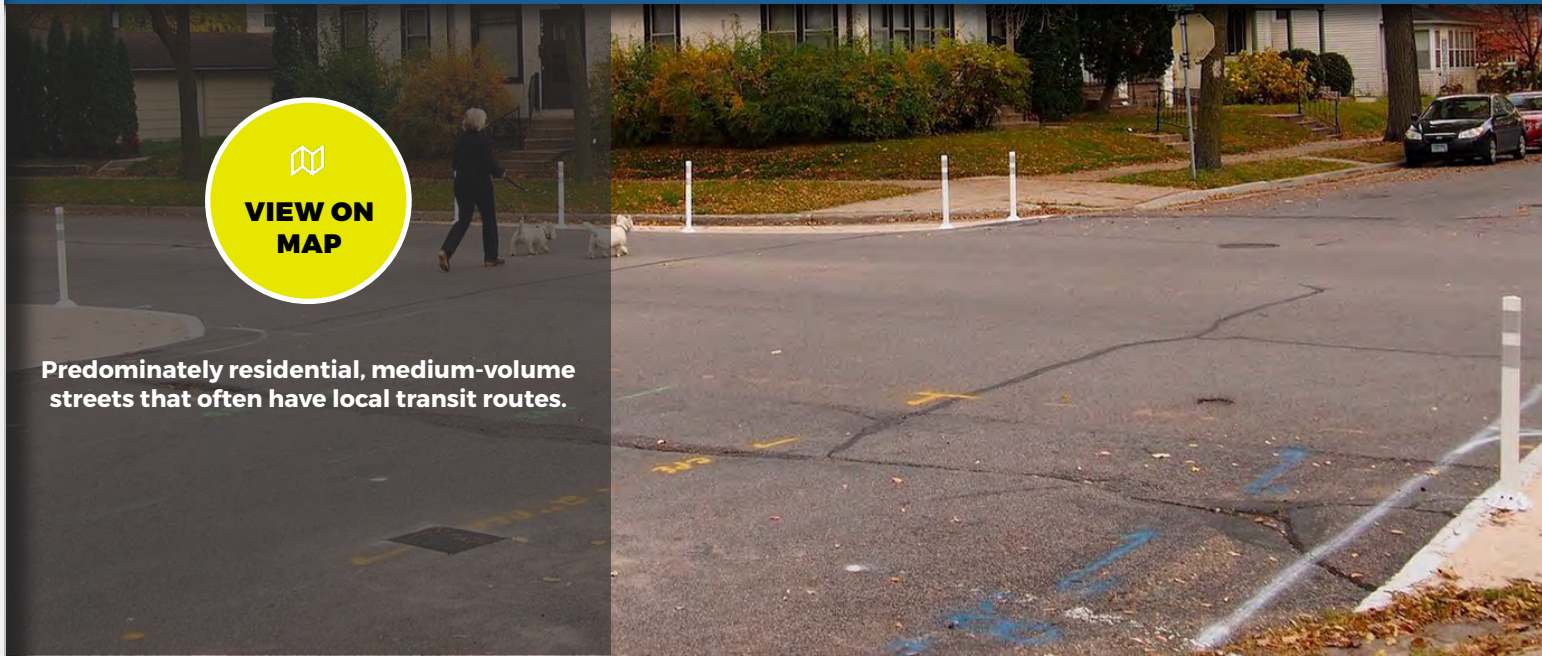

Predominately residential, medium-volume streets that often have local transit routes.

DESCRIPTION

Urban Neighborhood Connectors are predominately residential, medium-volume streets (typically 1,500-5,000 average daily traffic) that often have local transit routes. They provide connections between Mixed Use streets and Urban Neighborhood streets, but are not typically intended for through motor vehicle trips of longer than one mile.

Examples include portions of Thomas Avenue North, Monroe Street Northeast, and Grand Avenue.

TYPICAL CHARACTERISTICS

Miles	~44 miles Approximately 4% of total street centerline mileage
Right of Way Width	Mostly 60', 66', and 80'
Effective Right of Way	Varies; most commonly 55', 59', and 64'
Functional Class	Mostly Collector and some Local
Jurisdiction	City of Minneapolis
Route	Mostly Municipal State Aid
Modal Network	<ul style="list-style-type: none"> • Pedestrian Priority Network (most) • Transit routes (most) • All Ages and Abilities Bikeway Network (some)
Snow Emergency Route	Yes, typically
Historic Street	No

TYPICAL DESIGN AND OPERATIONS

See [Street Design Guidance chapter](#) for more information

A. Sidewalk	<ol style="list-style-type: none"> 1. 6' typical pedestrian clear width 2. 2'+ frontage width to any obstructions; in commercial nodes, wider frontage zones should be considered when appropriate to support transit shelters, sidewalk cafes, retail displays, landscaping, or other features that make the pedestrian environment more attractive. <p>See sidewalks guidance for more details.</p>
B. Boulevard and Furnishing	<ol style="list-style-type: none"> 1. 5'+ typical width (6'+ when possible), including 8" wide curb 2. Wider boulevard and furnishing zones should be used when feasible to support features that make the pedestrian environment more attractive and comfortable, support tree health, and maximize green stormwater infrastructure. 3. Every effort should be made to include 5' of space on both sides of the street to support healthy street trees, green stormwater infrastructure, and space for snow storage. See street trees guidance for more details. If needed, these strategies should be considered, in combination as needed, to support healthy trees on both sides of the street: <ul style="list-style-type: none"> » Eliminating parking from one side of the street; » Provide midblock curb extensions to provide space for trees in between pockets of parking spaces; » Narrowing the total roadway width from 36' to 35' or 34' if 2-sided parking; » Narrowing the sidewalk width to 5.5' or 5' (a 5' minimum clear zone should be maintained throughout); or » If trying to fit trees in with 4.5'-wide boulevard, work with the Park Board Forrester to ensure that the types of trees planted will have a higher likelihood of survival and less disruption to the sidewalk in narrower boulevard. » If tree-supporting boulevards are still not feasible on both sides of the street, narrow or eliminate the boulevard from one side of the street (while retaining enough width for utilities, signs, and other furnishings) to make enough space on at least one side of the street. Greening should still be used in the narrowed boulevard if possible. 4. In commercial nodes, consider sections of paved boulevard when appropriate to support sidewalk cafes and higher volumes of pedestrians. <p>See boulevards and furnishings guidance for more details.</p>
C. Bikeway	<p>For street reconstruction projects on the All Ages and Abilities bikeway network, sidewalk-level protected bike lanes should be used or a shared use path if protected bike lanes are not feasible. Protected and unprotected bike lanes can be considered for retrofit projects.</p>
D. Transit	<ol style="list-style-type: none"> 1. Typically includes local bus service, but not high frequency service. 2. In-lane bus stops will be used frequently. Consider use of 1' wide hardened centerline adjacent to in-lane bus stops. 3. Local bus stops will typically be used.
E. Freight	<p>Not typically on the Truck Route Network, but local deliveries can occur.</p>

F. Roadway

1. The roadway typically includes 2-way traffic and should be limited to one travel lane in each direction.
2. Standard roadway widths include:
 - » 10' traffic lanes
 - » 2' gutter pans
 - For streets with constrained right of way, designers can consider 1' gutter pans or an integral 11' wide concrete lane. Flooding concerns may make narrower gutter pans infeasible; coordinate with Surface Water and Sewers.
 - » 7'-8' parking lanes (including gutter pans)
 - In addition to vehicle parking, this area may include other uses such as loading and unloading zones, drop-off zones, bicycle corrals, parklets, street cafes, and greening. See [vehicle parking and curbside uses guidance](#) for more detail.
3. The amount of motor vehicle parking should typically be right sized to target greater than 60% occupancy to reduce speeding and maximize greening. Streets should generally combine sections of no parking, parking on both sides, and parking on one side to maximize greening and traffic calming. Extra consideration should be made to replace parking with expanded greening on "short block" Urban Neighborhood Connector streets, which often have no or few properties directly fronting them.
4. Chicanes should be considered to support safer travel speeds.
5. A dashed centerline is typically included, but parking lanes are typically unmarked.

G. Design speed

25 mph.
See [design speed guidance](#) for more detail

H. Design vehicle

Generally Aerial Fire Truck Mid Mount 100.
See [design and control vehicles guidance](#) for more details.

I. Control vehicle

Most commonly DL-23, but can also be SU-30 or WB-40 depending on intersecting street and context.
See [design and control vehicles guidance](#) for more details.

J. Motor Vehicle Property Access

1. New driveways should be limited to locations without alley or cross street access.
2. Designers should explore removing driveways that are no longer being used, are no longer permitted, or where access is provided via an alley. Designers should also explore right-sizing driveway curb cuts.

See [driveways guidance](#) for more details.

K. Intersection Traffic Control

Stop control or signal control

L. Intersection details

1. [Curb extensions](#) should generally be used whenever there is parking.
2. [Raised pedestrian crossings](#) should generally be included if there is a protected bike lane or shared use path whenever the bikeway crosses an Urban Neighborhood street.
3. See guidance for [in-lane bus stops](#).
4. When intersecting a [neighborhood greenway](#) or high-volume pedestrian crossing, consider crossing improvements. Options include traffic signals, [bicycle and pedestrian safety islands](#), [curb extensions](#), and/or Rectangular Rapid Flashing Beacons. See [NACTO's Urban Bikeway Design Guide](#) for additional options and details. Coordinate with Traffic and Parking Services to consider appropriate treatments at a given location.

TYPICAL CROSS SECTIONS

Figure 2.4.1:

2-way Urban Neighborhood Connector street with 1-side parking and no bikeway (55' effective right of way)

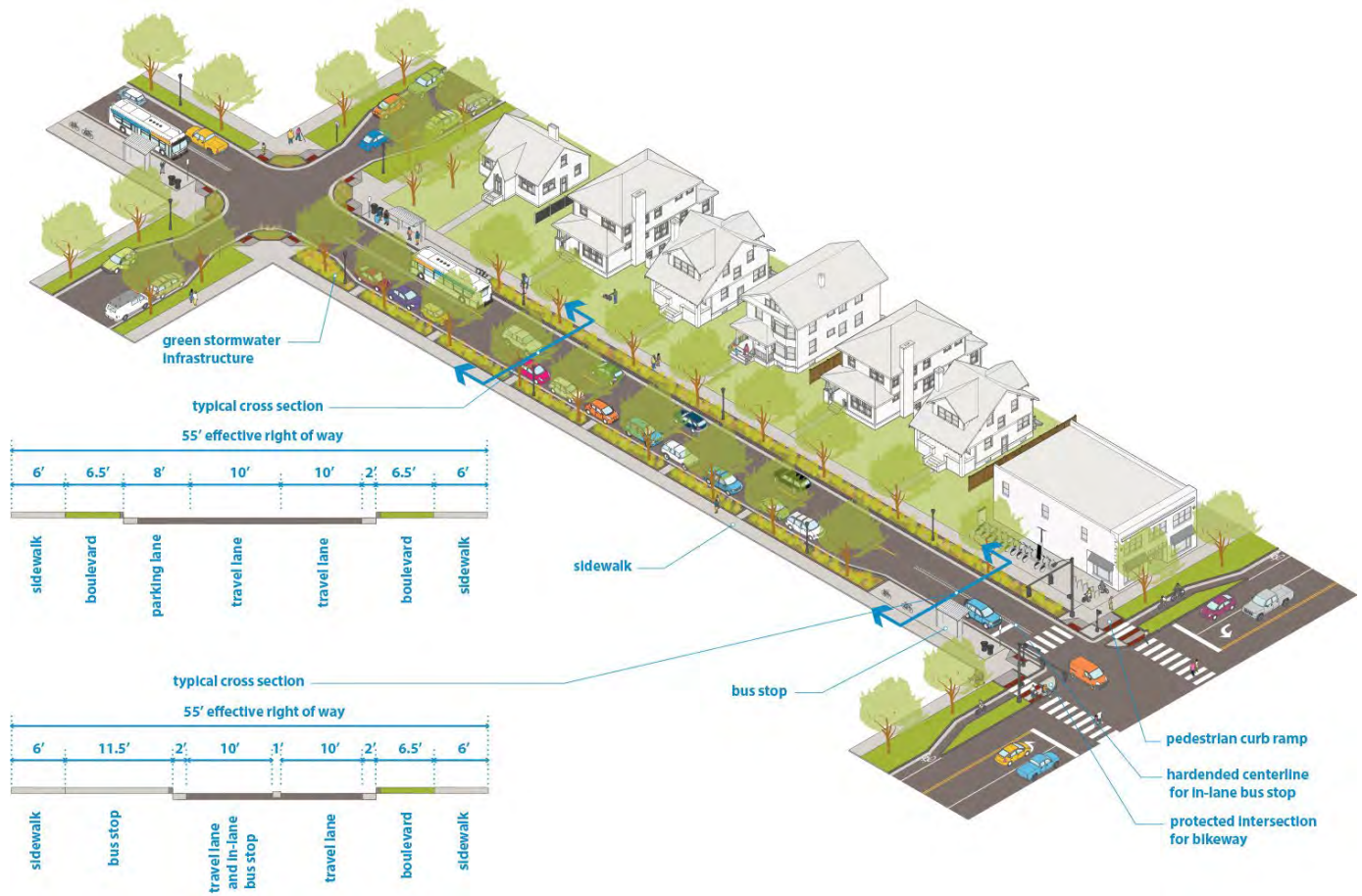

2.4 Urban Neighborhood Connectors

Figure 2.4.2:

2-way Urban Neighborhood Connector street with 1-side parking and shared use path (59' effective right of way)

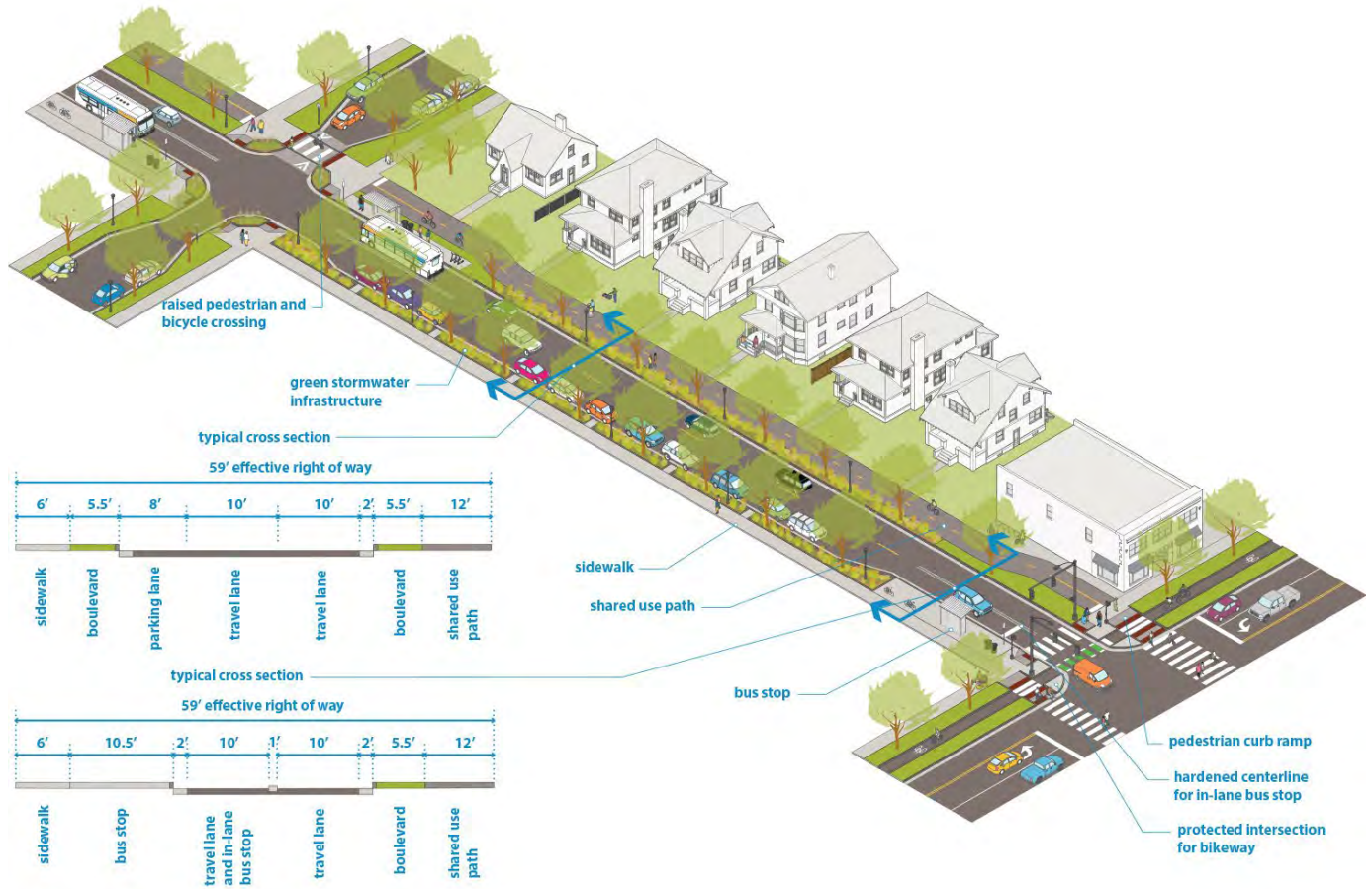

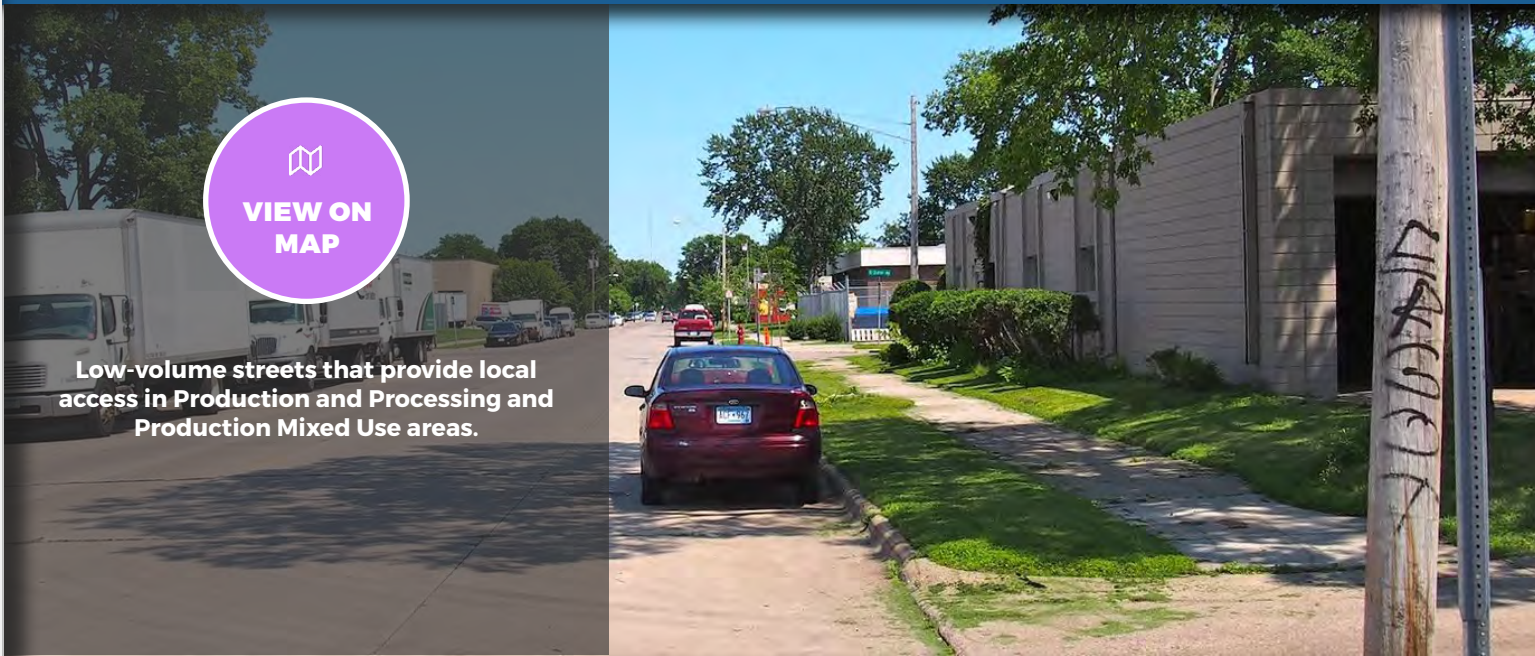

Low-volume streets that provide local access in Production and Processing and Production Mixed Use areas.

DESCRIPTION

Production and Processing streets are low-volume streets that provide local access in Production and Processing and Production Mixed Use areas as identified in the [Minneapolis 2040 Plan](#). They are typically very short (1-2 blocks) and are not intended for through motor vehicle trips. Production and Processing streets see a high number of trucks and large vehicles

Examples include Pacific Street, Kennedy Street Northeast, and a portion of Snelling Avenue.

TYPICAL CHARACTERISTICS

Miles	-19 miles Approximately 2% of total street centerline mileage
Right of Way Width	Mostly 60' and 66' Reflects conditions on 66% of blocks
Effective Right of Way	Varies, generally between 55' and 66'
Functional Class	Local
Jurisdiction	City of Minneapolis
Route	Local or Municipal State Aid
Modal Network	None
Snow Emergency Route	Sometimes
Historic Street	Not Typically

TYPICAL DESIGN AND OPERATIONS

See [Street Design Guidance chapter](#) for more information

A. Sidewalk	<ol style="list-style-type: none"> 1. 6' typical pedestrian clear width 2. 2'+ frontage width to any obstructions <p>See sidewalks guidance for more details.</p>
B. Boulevard and Furnishing	<ol style="list-style-type: none"> 1. 5'+ typical width, including 8" wide curb 2. Traditionally, many of these streets have little to no greening. However, as Production and Processing streets are reconstructed, wider boulevard and furnishing zones should be used whenever feasible to support features that make the pedestrian environment more attractive and comfortable, support tree health, and maximize green stormwater infrastructure. 3. Every effort should be made to include 5' of space on both sides of the street to support healthy street trees, green stormwater infrastructure, and space for snow storage. See street trees guidance for more details. If needed, these strategies should be considered, in combination as needed, to support healthy trees on both sides of the street: <ul style="list-style-type: none"> » Eliminating parking from one side of the street; » If 2-sided parking, narrow the roadway width below 36'; » Narrowing the sidewalk width to 5.5' or 5' (a 5' minimum clear zone should be maintained throughout); or » If trying to fit trees in with 4.5'-wide boulevard, work with the Park Board Forrester to ensure that the types of trees planted will have a higher likelihood of survival and less disruption to the sidewalk in narrower boulevard. » If tree-supporting boulevards are still not feasible on both sides of the street, narrow or eliminate the boulevard from one side of the street to make enough space on at least one side of the street. Greening should still be used in the narrowed boulevard if possible. <p>See boulevards and furnishings guidance for more details.</p>
C. Bikeway	<p>Not typically on the bikeway network.</p>
D. Transit	<p>Transit service is not typically provided.</p>
E. Freight	<p>Not typically on the Truck Route Network, but large trucks and commercial vehicles are frequent and should be designed for.</p>
F. Roadway	<ol style="list-style-type: none"> 1. The roadway typically includes 2-way traffic and should be limited to one travel lane in each direction. 2. Standard roadway widths include: <ul style="list-style-type: none"> » 36' with parking on both sides, including 2' gutter. On streets that are only 1 block long or have infrequent on-street truck parking, consider 32'-34'. » 31' with parking on 1 side, including 2' gutter » 24' with no parking, including 2' gutter 3. The amount of motor vehicle parking should typically be right sized to target greater than 60% occupancy to reduce speeding and maximize greening and green stormwater infrastructure. 4. Lane markings should not typically be included; users negotiate in a shared space.

2.5 Production and Processing

G. Design speed	20 mph See design speed guidance for more detail.
H. Design vehicle	Generally WB-40. See design and control vehicles guidance for more details.
I. Control vehicle	Most commonly WB-62, but can also be Aerial Fire Truck Mid Mount 100 depending on intersecting street and context. See design and control vehicles guidance for more details.
J. Motor Vehicle Property Access	New driveways should be limited to locations without alley or cross street access. Wide or multiple access points should be narrowed or consolidated where feasible while balancing needs for large truck access. See driveways guidance for more details.
K. Intersection Traffic Control	Stop control, yield control, or signal control
L. Intersection details	Consider curb extensions , but they may not be appropriate given the frequency of large trucks.

TYPICAL CROSS SECTIONS

Figure 2.5.1:

2-way Production and Processing street with 1-side parking (55' effective right of way)

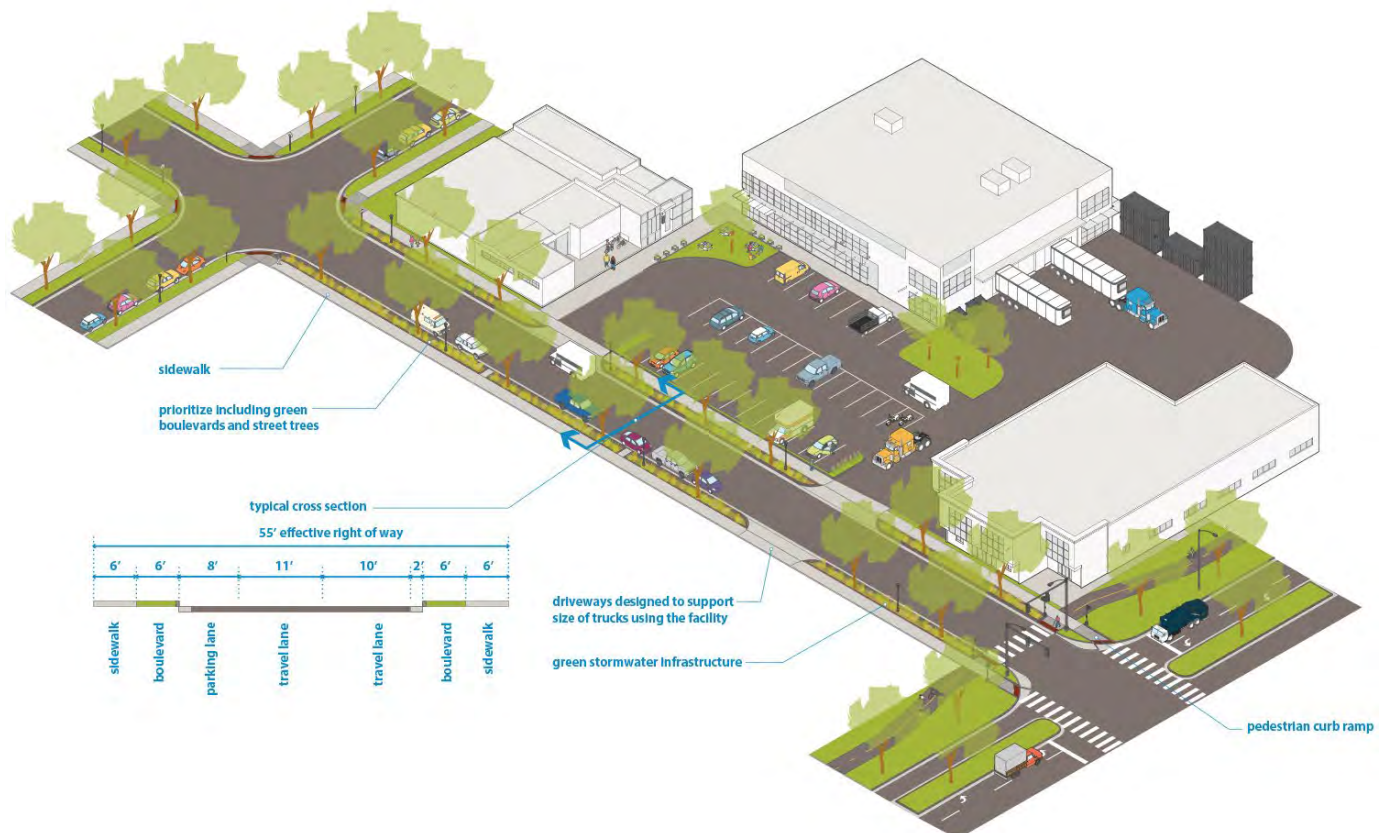

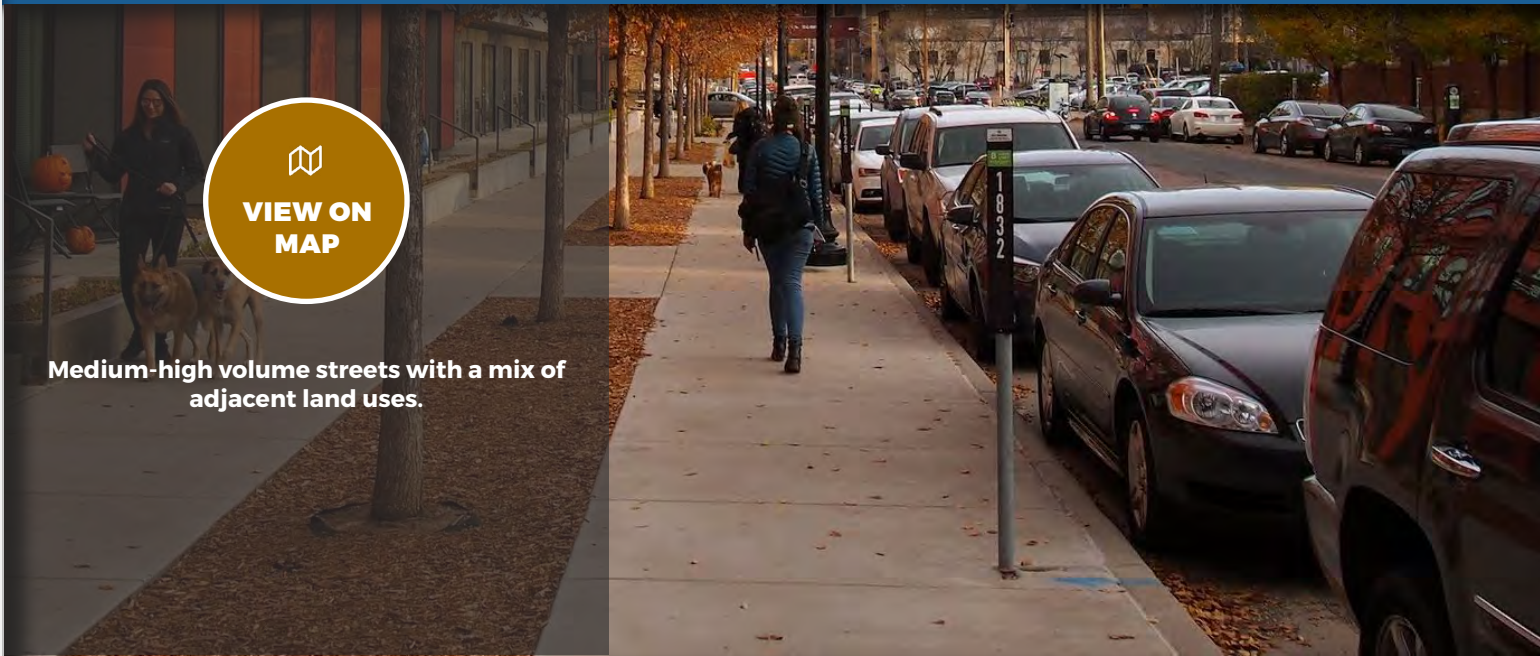

Medium-high volume streets with a mix of adjacent land uses.

DESCRIPTION

Mixed Use Community Connector are medium-high volume streets (typically 4,000-15,000 average daily traffic) with a mix of adjacent land uses. These streets have varying levels of walking and bicycling demand, often have transit routes, and provide neighborhood and cross-city connections for motor vehicles.

Examples include Fremont Avenue North, Marshall Street Northeast, and most of 31st Street.

TYPICAL CHARACTERISTICS

Miles	~139 miles Approximately 13% of total street centerline mileage
Right of Way Width	Varies; mostly 66', 80', 60', or 100'
Effective Right of Way	Varies widely; generally between 55' and 88'
Functional Class	Mostly Minor Arterial or Collector
Jurisdiction	Mostly City of Minneapolis or Hennepin County
Route	Mostly Municipal State Aid or County State Aid Highway
Modal Network	<ul style="list-style-type: none"> • Pedestrian Priority Network (many) • Transit routes (many) • Transit Priority Projects (some) • All Ages and Abilities bikeway network (majority) • Truck Route Network (some)
Snow Emergency Route	Yes
Historic Street	No

TYPICAL DESIGN AND OPERATIONS

See [Street Design Guidance chapter](#) for more information

A. Sidewalk

1. 6' typical pedestrian clear width

2. 2'+ frontage width to any obstructions

See [sidewalks guidance](#) for more details.

B. Boulevard and Furnishing

1. 5'+ typical width, including 8" wide [curb](#)

2. Wider boulevard and furnishing zones should be used when feasible to support features that make the pedestrian environment more attractive and comfortable, support tree health, and maximize [green stormwater infrastructure](#).

3. Every effort should be made to include 5' of space on both sides of the street to support healthy street trees, green stormwater infrastructure, space for snow storage, and to provide separation between pedestrians and motor vehicles. See [street trees guidance](#) for more details. If needed, these strategies should be considered, in combination as needed, to support healthy trees on both sides of the street:

- » Eliminating parking from one or both sides of the street;
- » Provide midblock curb extensions to provide space for trees in between parking spaces;
- » Narrowing the sidewalk width to 5.5' or 5' (a 5' minimum clear zone should be maintained throughout); or
- » if trying to fit trees in with 4.5'-wide boulevard, work with the Park Board Forrester to ensure that the types of trees planted will have a higher likelihood of survival and less disruption to the sidewalk in narrower boulevard.
- » If tree-supporting boulevards are still not feasible on both sides of the street, narrow or eliminate the boulevard from one side of the street to make enough space on at least one side of the street. Greening should still be used in the narrowed boulevard if possible.
- » In commercial nodes, consider sections of paved boulevard when appropriate to support sidewalk cafes and higher volumes of pedestrians.

See [boulevards and furnishings guidance](#) for more details.

C. Bikeway

For street reconstruction projects on the All Ages and Abilities bikeway network, [sidewalk-level protected bike lanes](#) should be used or a [shared use path](#) if protected bike lanes are not feasible. [Protected](#) and [unprotected bike lanes](#) can be considered for retrofit projects.

D. Transit

1. Frequently have local bus service and some have arterial bus rapid transit routes.

2. [Local bus stops](#) or [bus rapid transit stations](#) should be used accordingly.

3. [In-lane bus stops](#) will be used in some locations and should be considered.

4. [Bus-only lanes](#) and other transit advantages should be considered for Transit Priority Corridors.

E. Freight

Some Mixed Use Community Connectors are on the Truck Route Network; periodic truck traffic will happen on all streets.

F. Roadway

1. The roadway typically includes 2-way traffic, although includes several one-way pairs.

2. The roadway should generally be limited to one travel lane in each direction with turn lanes as appropriate at intersections (most one-way Mixed Use Community Connectors will have two lanes). Two lanes in each direction may be appropriate in some cases, but four-lane undivided streets should be avoided. If two lanes in each direction are included, they should frequently be done in combination with off-peak parking and loading zones. More than two lanes in each direction should only be considered in combination with bus-only lanes or off-peak parking.

3. Standard roadway widths include:

- » 10' traffic lanes
 - For streets with high-frequency bus service or heavy semitruck volumes, one travel lane of 11' in each direction may be considered. Curb adjacent traffic lanes should not be wider than 10' given the adjacent gutter pan.
- » 2' gutter pans
 - For streets with constrained right of way, designers can consider 1' gutter pans or an integral 11' wide concrete lane. Flooding concerns may make narrower gutter pans infeasible; coordinate with Surface Water and Sewers.
 - 1' gutter pans adjacent to medians when there are no catch basins
- » 10' turn-only lanes
 - For turn lanes with heavy bus or heavy truck volumes, 11' may be considered.
- » Details on [bus-only lanes](#) are available here.
- » 8' parking lanes or other curbside use (including gutter)
 - In addition to vehicle parking, this area may include other uses such as loading and unloading zones, drop-off zones, bicycle corrals, parklets, street cafes, and greening. See vehicle parking and curbside uses guidance for more detail.
 - 7' parking lanes can be considered in residential areas with constrained right of way
- » 8' bus stop pull out
 - 7' bus stop pull outs may be considered in constrained right of way
- » 6'+ [medians](#)
 - Medians greater than 6' provide an accessible pedestrian refuge space
 - Consider widths greater than 8' along major bike crossings to provide adequate refuge space for bikes
 - 4' medians can be considered in constrained right of way
 - Medians should include [greening](#) when feasible

4. The amount of motor vehicle parking should typically be right sized to target greater than 75% occupancy to reduce speeding and maximize greening. Streets should often combine sections of no parking, parking on both sides, parking on one side, and off-peak parking to maximize greening and traffic calming.

5. Lane markings should be included; parking lanes may or may not be striped

G. Design speed	<p>25 mph</p> <p>See design speed guidance for more detail.</p>
H. Design vehicle	<p>Most commonly SU-30, but can also be WB-40 depending on intersecting street and context.</p> <p>See design and control vehicles guidance for more details.</p>
I. Control vehicle	<p>Most commonly Aerial Fire Truck Mid Mount 100, but can also be WB-62 depending on intersecting street and context.</p> <p>See design and control vehicles guidance for more details.</p>
J. Motor Vehicle Property Access	<ol style="list-style-type: none"> 1. New driveways should be limited to locations without alley or cross street access. 2. Designers should explore removing driveways that are no longer being used, are no longer permitted, or where access is provided via an alley. Designers should also explore right-sizing driveway curb cuts. <p>See driveways guidance for more details.</p>
K. Intersection Traffic Control	<p>Signal control or stop control</p>
L. Intersection details	<ol style="list-style-type: none"> 1. Curb extensions should generally be used whenever there is parking. 2. Raised pedestrian crossings should generally be included if there is a protected bike lane or shared use path whenever the bikeway crosses an Urban Neighborhood street. Raised pedestrian crossings should also generally be used in high-pedestrian areas when crossing an Urban Neighborhood street. 3. See guidance for in-lane bus stops. 4. When intersecting a neighborhood greenway or high-volume pedestrian crossing, include crossing improvements. Options include traffic signals, bicycle and pedestrian safety islands, curb extensions, and/or Rectangular Rapid Flashing Beacons. See NACTO's Urban Bikeway Design Guide for additional options and details. Coordinate with Traffic and Parking Services to consider appropriate treatments at a given location.

TYPICAL CROSS SECTIONS

Figure 2.6.1:

2-way Mixed Use Community Connector street with 2-way protected bike lanes and no bus stops (60' effective right of way)

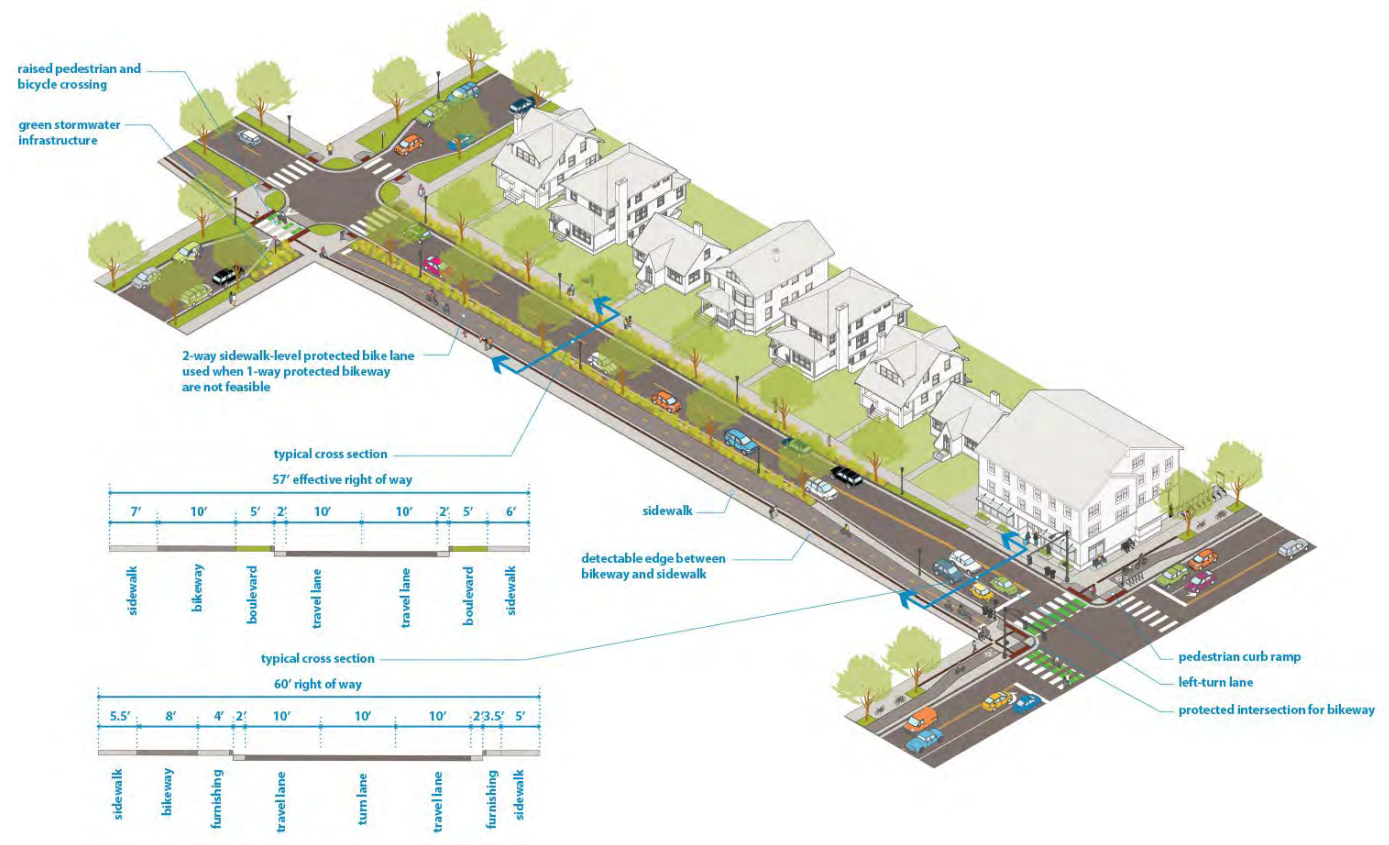

2.6 Mixed Use Community Connectors

Figure 2.6.2:

2-way Mixed Use Community Connector street with 1-way protected bike lanes and bus stops (64' effective right of way)

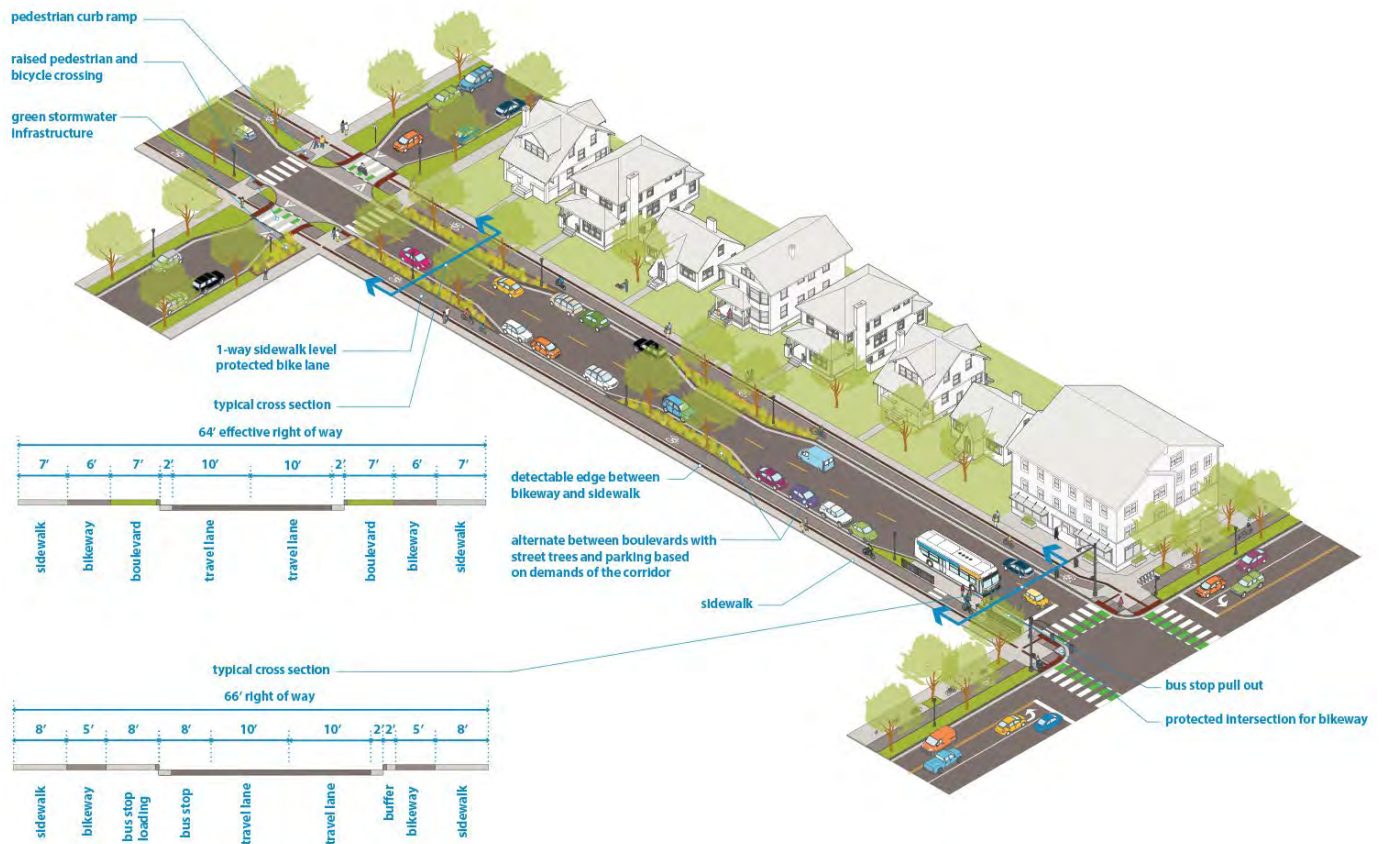

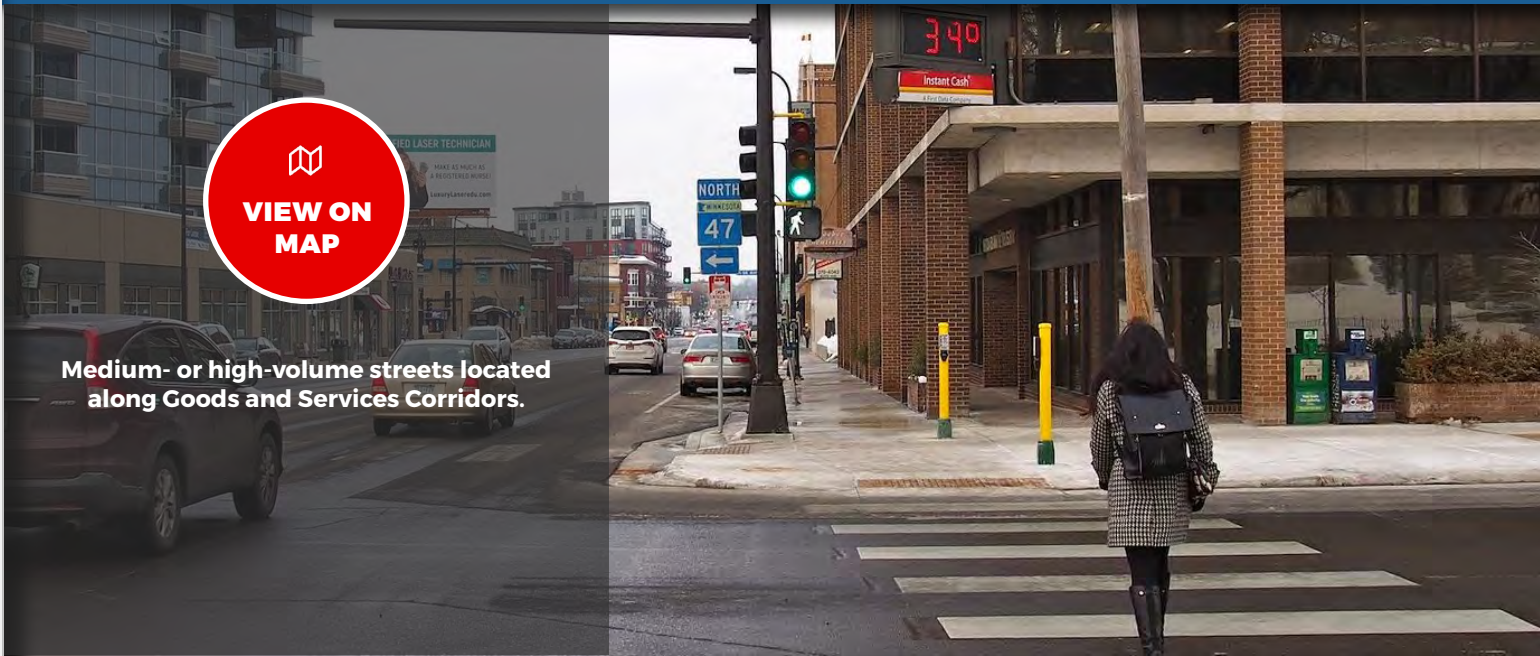

DESCRIPTION

Mixed Use Commercial Connectors are medium- or high-volume streets (typically 5,000-20,000 average daily traffic) located along Goods and Services Corridors (as identified in the [Minneapolis 2040 Plan](#)). These streets generally have high walking and bicycling demand, transit routes, and serve medium distance connections across neighborhoods, to commercial destinations, and often to the regional highway system.

Examples include West Broadway Avenue North, Central Avenue Northeast, and Lake Street.

TYPICAL CHARACTERISTICS

Miles	~86 miles Approximately 8% of total street centerline mileage
Right of Way Width	Mostly 80', 66', or 100'
Effective Right of Way	Varies widely; mostly between 59' and 100'
Functional Class	Mostly Minor Arterial; some Collector
Jurisdiction	<ul style="list-style-type: none"> • Hennepin County (majority) • City of Minneapolis (some) • MnDOT (a few)
Route	County State Aid Highway, Municipal State Aid, or State Trunk Highway
Modal Network	<ul style="list-style-type: none"> • Pedestrian Priority Network (all) • Transit routes (all) • Transit Priority Projects (many) • All Ages and Abilities Bikeway (some) • Truck Route (most)
Snow Emergency Route	Yes
Historic Street	No

TYPICAL DESIGN AND OPERATIONS

See [Street Design Guidance chapter](#) for more information

A. Sidewalk	<ol style="list-style-type: none"> 1. 6'-10' recommended pedestrian clear width depending on pedestrian volumes, intensity of adjacent commercial land uses, and other demands in the right of way. 2. 2'+ frontage width to any obstructions; wider frontage zones should be considered when appropriate to support transit shelters, sidewalk cafes, retail displays, landscaping, or other features that make the pedestrian environment more attractive. <p>See sidewalks guidance for more details.</p>
B. Boulevard and Furnishing	<ol style="list-style-type: none"> 1. 6'+ recommended width, including 8"-14" wide curb. 2. Wider boulevard and furnishing zones should be used when feasible to support features that make the pedestrian environment more attractive and comfortable, support tree health, and maximize green stormwater infrastructure. 3. Effort should be made to include 5' of space on both sides of the street to support healthy street trees, green stormwater infrastructure, space for snow storage, and to provide separation between pedestrians and motor vehicles. See street trees guidance for more details. If needed, these strategies should be considered, in combination as needed, to support healthy trees on both sides of the street: <ul style="list-style-type: none"> » Eliminating parking from one or both sides of the street; » Provide midblock curb extensions to provide space for trees in between parking spaces; » Using a 6' sidewalk clear zone width; or » if trying to fit trees in with 4.5'-wide boulevard, work with the Park Board Forrester to ensure that the types of trees planted will have a higher likelihood of survival and less disruption to the sidewalk in narrower boulevard. » If tree-supporting boulevards are still not feasible on both sides of the street, narrow or eliminate the boulevard from one side of the street to make enough space on at least one side of the street. Greening should still be used in the narrowed boulevard if possible. » In commercial nodes, consider sections of paved boulevard when appropriate to support sidewalk cafes and higher volumes of pedestrians. <p>See boulevards and furnishings guidance for more details.</p>
C. Bikeway	<p>For street reconstruction projects on the All Ages and Abilities bikeway network, sidewalk-level protected bike lanes should generally be used. Protected and unprotected bike lanes can be considered for retrofit projects</p>
D. Transit	<ol style="list-style-type: none"> 1. Frequently have local bus service and bus rapid transit routes. 2. Local bus stops or bus rapid transit stations should be used accordingly. 3. Bus-only lanes and other transit advantages should be considered for Transit Priority Corridors.
E. Freight	<p>Most Mixed Use Commercial Connectors are on the Truck Route Network; periodic truck traffic will happen on all streets.</p>

F. Roadway

1. The roadway typically includes 2-way traffic, although includes several one-way pairs.

2. The roadway should generally be limited to one travel lane in each direction with turn lanes as appropriate at intersections. Two lanes in each direction may be appropriate in some cases, but four-lane undivided streets should be avoided. If two lanes in each direction are included, they should frequently be done in combination with off-peak parking and loading zones. More than two lanes in each direction should only be considered in combination with bus-only lanes or off-peak parking.

3. Standard roadway widths include:

- » 10' traffic lanes
 - For streets with high-frequency bus service or heavy semitruck volumes, one travel lane of 11' in each direction may be considered. Curb adjacent traffic lanes should not be wider than 10' given the adjacent gutter pan.
- » 2' gutter pans
 - For streets with constrained right of way, designers can consider 1' gutter pans or an integral 11' wide concrete lane. Flooding concerns may make narrower gutter pans infeasible; coordinate with Surface Water and Sewers.
 - 1' gutter pans adjacent to medians when there are no catch basins
- » 10' turn-only lanes
 - For turn lanes with heavy bus or heavy truck volumes, 11' may be considered.
- » Details on [bus-only lanes](#) are available here.
- » 8' parking lanes or other curbside use (including gutter)
 - In addition to vehicle parking, this area may include other uses such as loading and unloading zones, drop-off zones, bicycle corrals, parklets, street cafes, and greening. See [vehicle parking and curbside uses guidance](#) for more detail.
- » 8' bus stop pull out
- » 6'+ [medians](#)
 - Medians greater than 6' provide an accessible pedestrian refuge space
 - Consider widths greater than 8' along major bike crossings to provide adequate refuge space for bikes
 - 4' medians can be considered in constrained right of way
- » Medians should include [greening](#) when feasible

4. Lane markings should be included and parking lanes should be striped

G. Design speed

25 mph

See [design speed guidance](#) for more detail.

H. Design vehicle

Most commonly SU-30, but can also be WB-40 depending on intersecting street and context.

See [design and control vehicles guidance](#) for more details.

I. Control vehicle

Most commonly Aerial Fire Truck Mid Mount 100, but can also be WB-62 depending on intersecting street and context.

See [design and control vehicles guidance](#) for more details.

J. Motor Vehicle Property Access

1. New driveways should be limited to locations without alley or cross street access.

2. Designers should explore removing driveways that are no longer being used, are no longer permitted, or where access is provided via an alley. Designers should also explore right-sizing driveway curb cuts.

See [driveways guidance](#) for more details.

K. Intersection Traffic Control	Signal control or stop control
L. Intersection details	<ol style="list-style-type: none"> 1. Curb extensions should generally be used whenever there is full-time parking. 2. Raised pedestrian crossings should generally be included whenever the Mixed Use Commercial Connector crosses an Urban Neighborhood street, especially if there is a protected bike lane or high pedestrian use. 3. When intersecting a neighborhood greenway or high-volume pedestrian crossing, include crossing improvements. Options include traffic signals, bicycle and pedestrian safety islands, curb extensions, and/or Rectangular Rapid Flashing Beacons. See NACTO's Urban Bikeway Design Guide for additional options and details. Coordinate with Traffic and Parking Services to consider appropriate treatments at a given location.

TYPICAL CROSS SECTIONS

Figure 2.7.1:

2-way Mixed Use Commercial Connector street with 1-way protected bike lanes and bus stops (80' effective right of way)

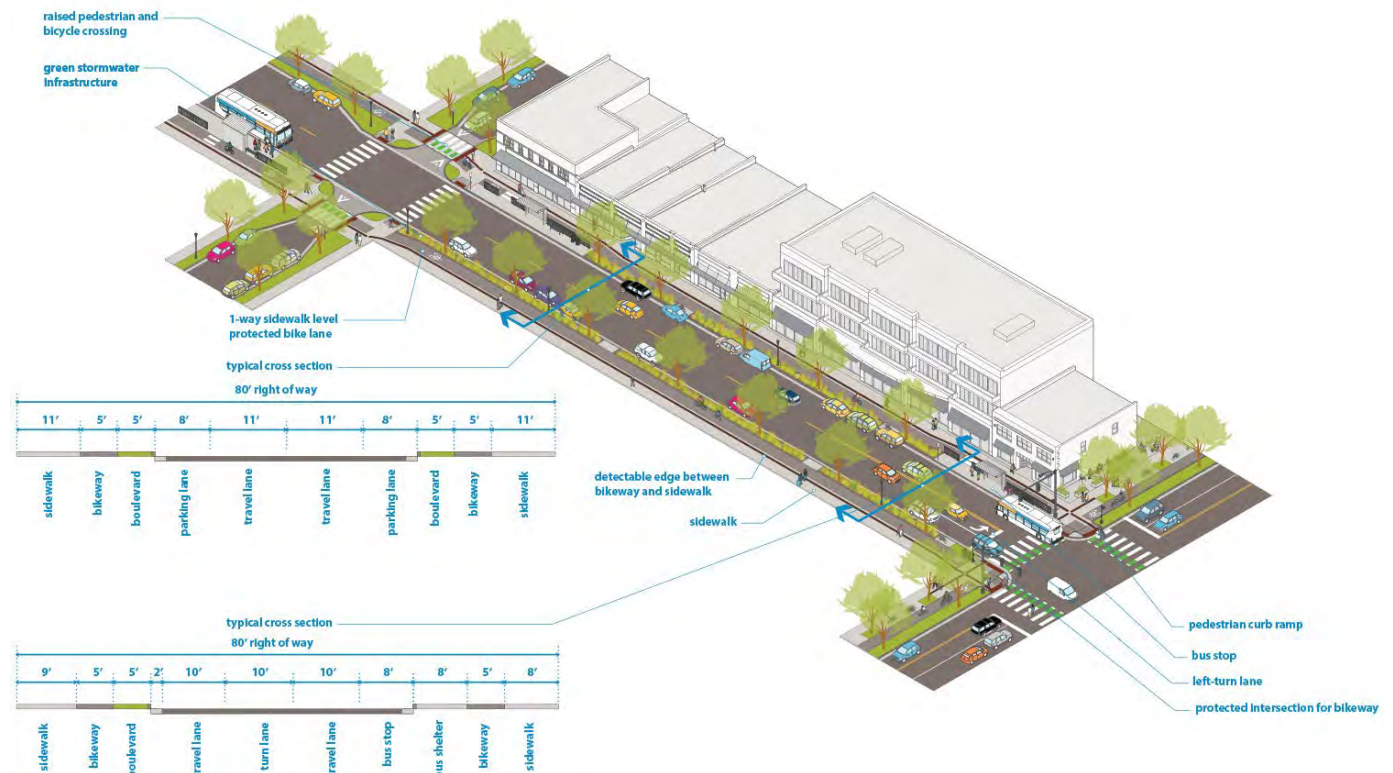

2.7 Mixed Use Commercial Connectors

Figure 2.7.2:

2-way Mixed Use Commercial Connector street with bus-only lanes
(86' effective right of way)

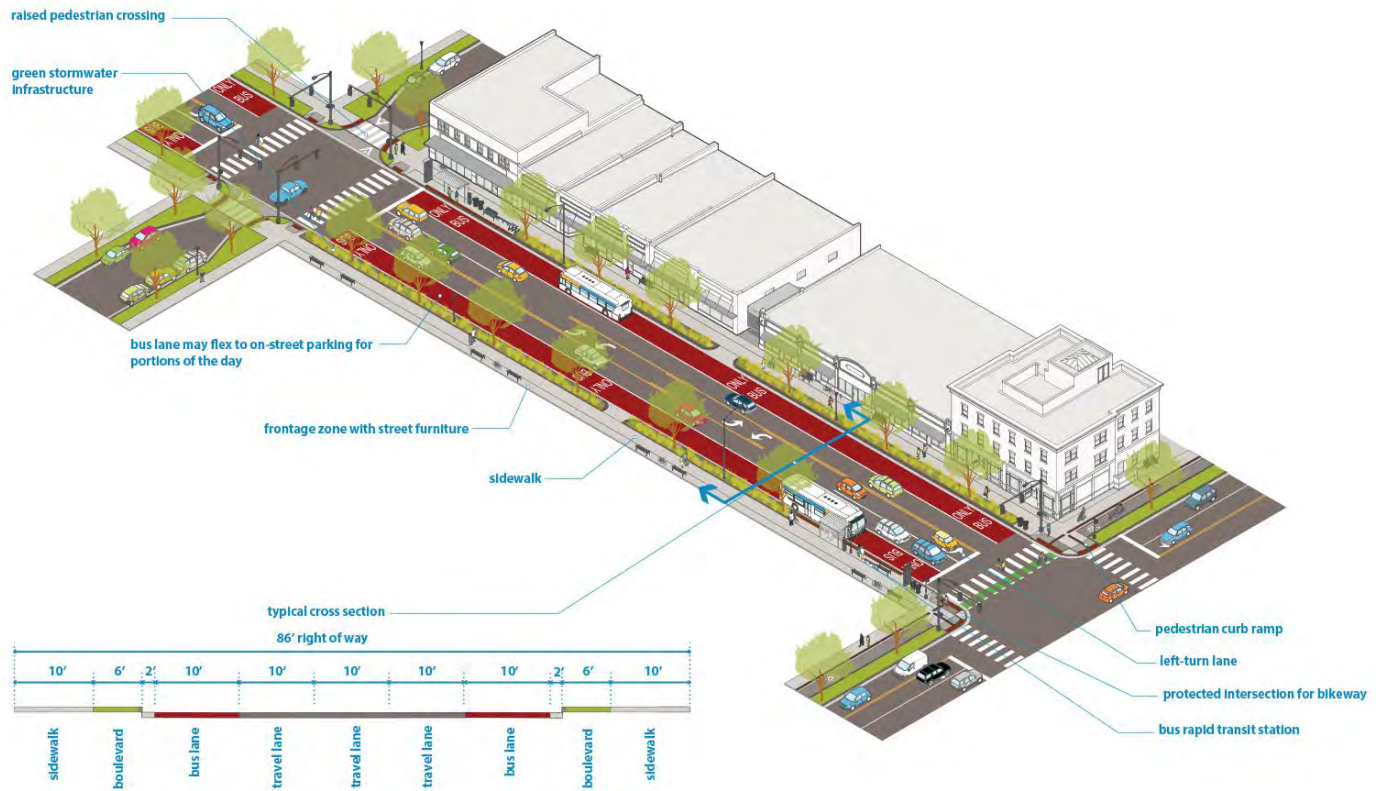

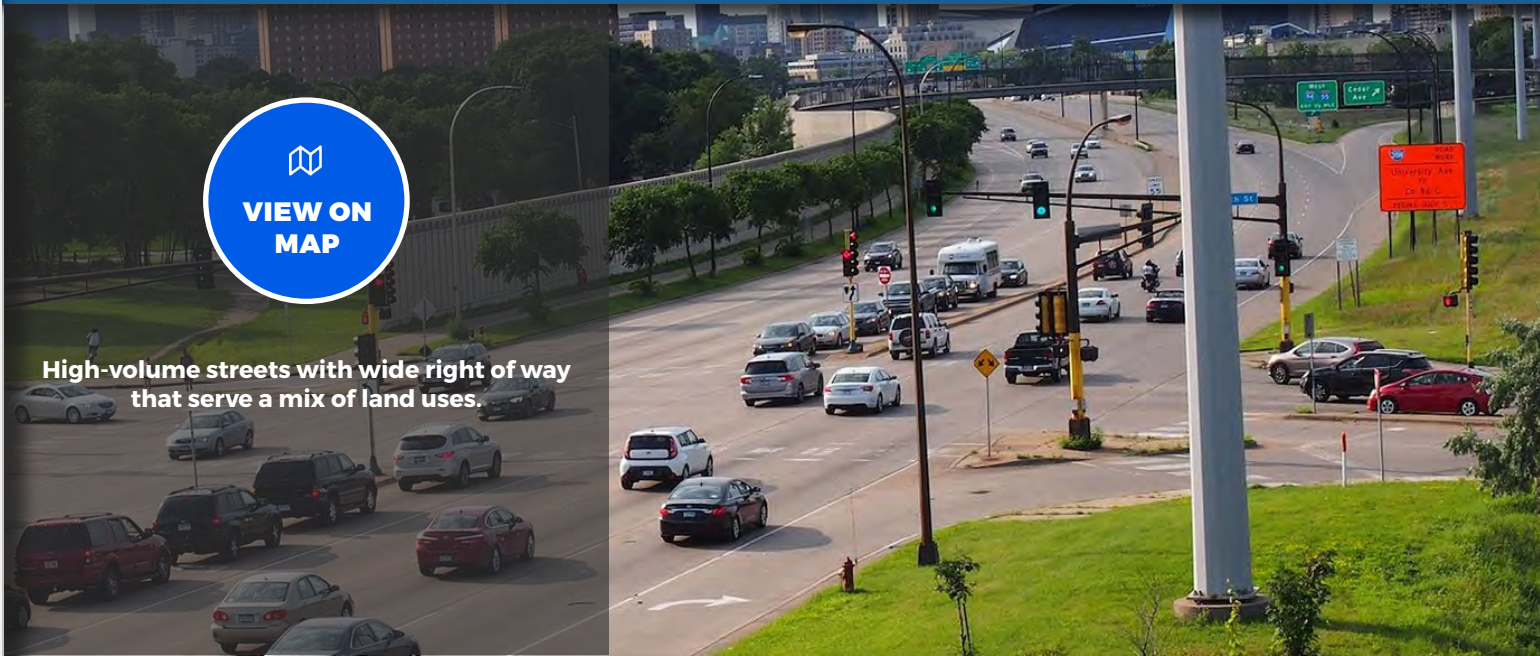

DESCRIPTION

Mixed Use Regional Connectors are high-volume streets (typically 10,000+ average daily traffic) with wide right of way that serve a mix of land uses. These streets often must balance providing local access and serving regional transportation connections. Mixed use Regional Connectors often include high-capacity transit and high walking demand.

Examples include Hiawatha Avenue, Olson Memorial Highway, and New Brighton Boulevard.

TYPICAL CHARACTERISTICS

Miles	~27 miles Approximately 2% of total street centerline mileage
Right of Way Width	Typically 130' or wider
Effective Right of Way	Typically 130' or wider
Functional Class	Principal Arterial or Minor Arterial
Jurisdiction	<ul style="list-style-type: none"> MnDOT (most) Hennepin County (some) City of Minneapolis (a few)
Route	State Trunk Highway, County State Aid Highway, or Municipal State Aid
Modal Network	<ul style="list-style-type: none"> Pedestrian Priority Network (many) Transit routes (most) Transit Priority Projects (many) All Ages and Abilities bikeway network (many) Truck Route Network (all)
Snow Emergency Route	Yes
Historic Street	No

TYPICAL DESIGN AND OPERATIONS

See [Street Design Guidance chapter](#) for more information.

A. Sidewalk	<ol style="list-style-type: none"> 1. Sidewalk, trail, or shared use path should be provided whenever there is adjacent current or planned land use or demand for walking. 2. 6'-8' recommended pedestrian clear width depending on pedestrian volumes, intensity of adjacent commercial land uses 3. 2'+ frontage width to any obstructions <p>See sidewalks guidance for more details.</p>
B. Boulevard and Furnishing	<ol style="list-style-type: none"> 1. 8'+ recommended width, including 8"-14" wide curb 2. Wider boulevard and furnishing zones should be used when feasible to support features that make the pedestrian environment more attractive and comfortable, support tree health, and maximize green stormwater infrastructure. 3. Street trees should be included on both sides of the street. See street trees guidance for more details. <p>See boulevards and furnishings guidance for more details.</p>
C. Bikeway	<p>For streets on the All Ages and Abilities bikeway network, trails should be used.</p>
D. Transit	<ol style="list-style-type: none"> 1. Some local bus service, bus rapid transit, and light rail transit operating in an exclusive right of way. 2. Local bus stops or bus rapid transit stations should be used accordingly. 3. Dedicated space for transit operations and other transit advantages should be provided for Transit Priority Corridors.
E. Freight	<p>All are on the Truck Route Network.</p>
F. Roadway	<ol style="list-style-type: none"> 1. Standard roadway widths include: <ul style="list-style-type: none"> » 10' to 11' traffic lanes, depending on context » 10' turn-only lanes » 2'-4' gutter pan/shoulder 2. Planted medians should be encouraged. 3. Turn-lanes should be included at most intersections.
G. Design speed	<p>30 - 40 mph</p> <p>See design speed guidance for more detail.</p>
H. Design vehicle	<p>Most commonly SU-30 or WB-40 depending on intersecting street and context.</p> <p>See design and control vehicles guidance for more details.</p>
I. Control vehicle	<p>Most commonly WB-62, but can also be Aerial Fire Truck Mid Mount 100 depending on intersecting street and context.</p> <p>See design and control vehicles guidance for more details.</p>

J. Motor Vehicle Property Access

1. New driveways should be limited to locations without alley or cross street access.
2. Designers should explore removing driveways that are no longer being used, are no longer permitted, or where access is provided via an alley. Designers should also explore right-sizing driveway curb cuts.

See [driveways guidance](#) for more details.

K. Intersection Traffic Control

Signal control or stop control

L. Intersection details

Slip lanes should be discouraged when interacting with any pedestrian crossing.

TYPICAL CROSS SECTIONS

Figure 2.8.1:

Mixed Use Regional Connector street with light rail transit and trail

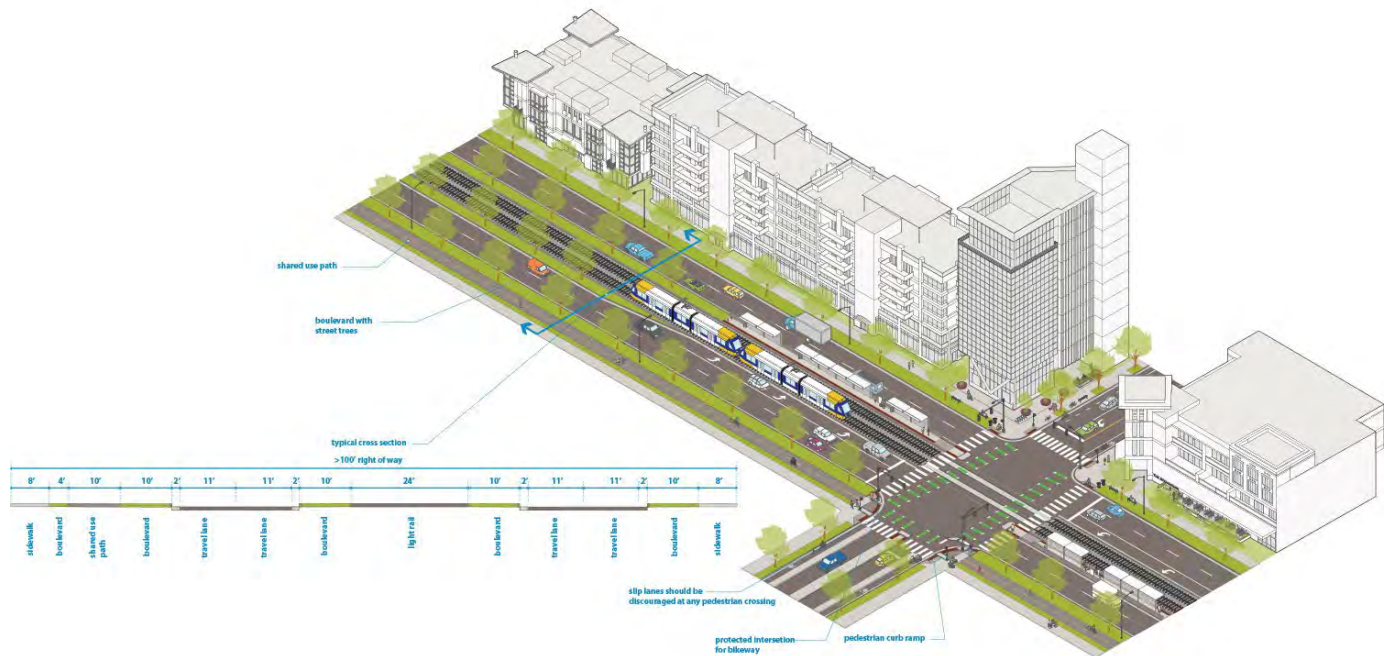

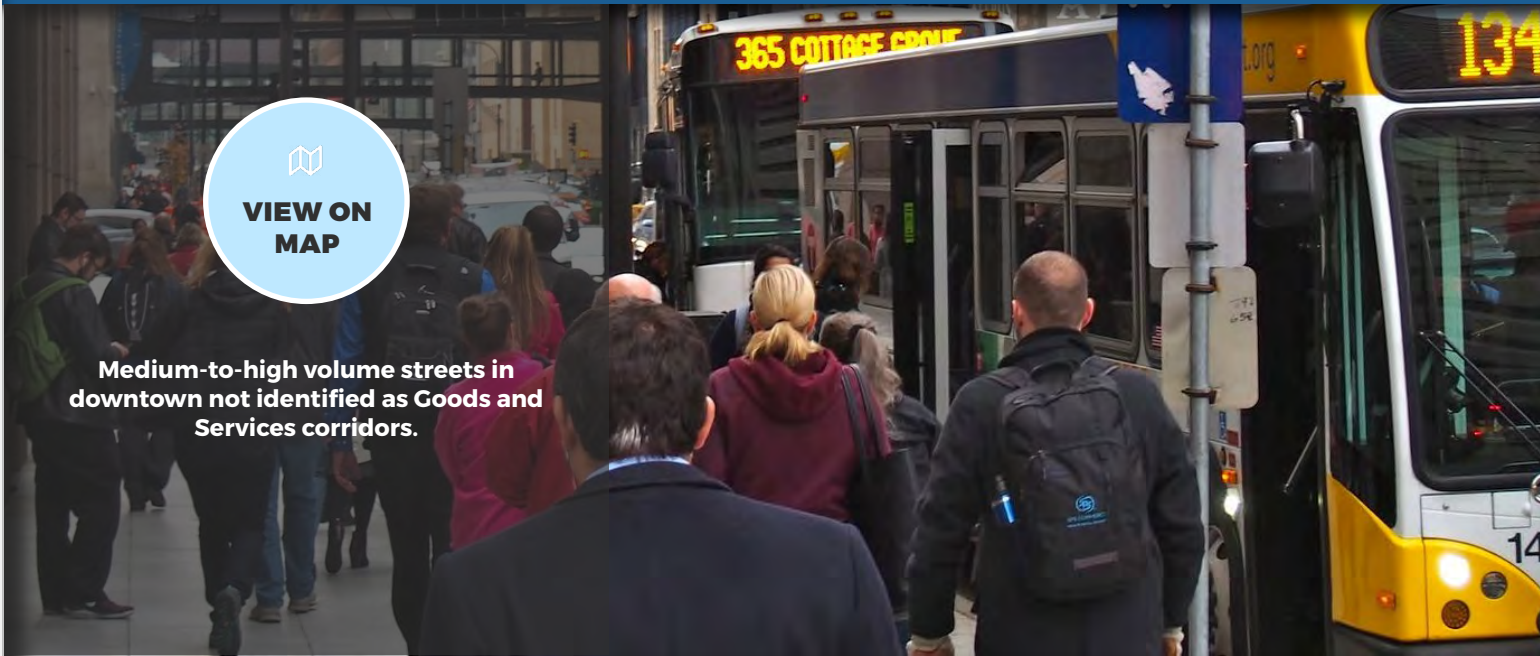

Medium-to-high volume streets in downtown not identified as Goods and Services corridors.

DESCRIPTION

Downtown Core streets are medium-to-high volume streets (typically 5,000-17,000 average daily traffic) in downtown that are not identified in the [Minneapolis 2040 Plan](#) as Goods and Services corridors. These streets generally have high walking and bicycling demand, transit routes, and connect motor vehicles from the regional highway system to downtown destinations.

Examples include 7th Street South and 3rd Avenue South.

TYPICAL CHARACTERISTICS

Miles	~17 miles Approximately 2% of total street centerline mileage
Right of Way Width	Mostly 80'
Effective Right of Way	Typically 80', but varies some
Functional Class	Minor Arterial or Collector
Jurisdiction	Mostly City of Minneapolis with a few Hennepin County
Route	Municipal State Aid or County State Aid Highway
Modal Network	<ul style="list-style-type: none"> • Pedestrian Priority Network (all) • All Ages and Abilities bikeway network (all) • Transit routes (most) • Transit Priority Corridors (many) • Truck Route Network (all)
Snow Emergency Route	Yes
Historic Street	No

TYPICAL DESIGN AND OPERATIONS

See [Street Design Guidance chapter](#) for more information

A. Sidewalk	<ol style="list-style-type: none"> 1. 8'-10' recommended pedestrian clear width depending on pedestrian volumes, intensity of adjacent commercial land uses, and other demands in the right of way. 2. 2'+ frontage width to any obstructions; wider frontage zones should be considered when appropriate to support transit shelters, sidewalk cafes, retail displays, landscaping, or other features that make the pedestrian environment more attractive. <p>See sidewalks guidance for more details.</p>
B. Boulevard and Furnishing	<ol style="list-style-type: none"> 1. 6'+ recommended width, including 14" wide curb 2. Wider boulevard and furnishing zones should be used when feasible to support features that make the pedestrian environment more attractive and comfortable, support tree health, and maximize green stormwater infrastructure. 3. Every effort should be made to include at least 5' of space on both sides of the street to support healthy street trees, green stormwater infrastructure, and to provide separation between pedestrians, bicyclists, and motor vehicles. See street trees guidance for more details. <p>See boulevards and furnishings guidance for more details.</p>
C. Bikeway	<ol style="list-style-type: none"> 1. For street reconstruction projects on the All Ages and Abilities bikeway network, sidewalk-level protected bike lanes should generally be used. 2. Protected and unprotected bike lanes can be considered for retrofit projects. 3. 2-way protected bike lanes should be strongly considered on one-way streets.
D. Transit	<ol style="list-style-type: none"> 1. Frequently have local bus service, express bus service, and bus rapid transit routes. 2. Local bus stops or bus rapid transit stations should be used accordingly. 3. Bus-only lanes and other transit advantages should be included for Transit Priority Projects and considered for other streets.
E. Freight	<p>Downtown Core streets are generally on the Truck Route Network.</p>

F. Roadway

1. One-way traffic is generally preferred in the downtown environment.
2. More than two lanes in each direction should generally be done only in combination with bus-only lanes or off-peak parking lanes.
3. Peak parking lanes should generally not be included, but off-peak parking lanes/loading zones should be regularly included.
4. Four-lane undivided two-way streets should be avoided.
5. Standard roadway widths include:
 - » 10' traffic lanes
 - For streets with high-frequency bus service or heavy semitruck volumes, one travel lane of 11' in each direction may be considered. Curb adjacent traffic lanes should not be wider than 10' given the adjacent gutter pan.
 - » 2' gutter pans
 - For streets with constrained right of way, designers can consider 1' gutter pans or an integral 11' wide concrete lane. Flooding concerns may make narrower gutter pans infeasible; coordinate with Surface Water and Sewers.
 - 1' gutter pans adjacent to medians when there are no catch basins
 - » 10' turn-only lanes
 - For turn lanes with heavy bus or heavy truck volumes, 11' may be considered.
 - » Details on [bus-only lanes](#) are available here.
 - » 8' parking lanes or other curbside use (includes gutter)
 - In addition to vehicle parking, this area may include other uses such as loading and unloading zones, drop-off zones, bicycle corrals, parklets, street cafes, and greening. See [vehicle parking and curbside uses](#) guidance for more detail.
 - » 8' bus stop pull out
 - » 6'+ [medians](#)
 - Medians greater than 6' provide an accessible pedestrian refuge space
 - Consider widths greater than 8' along major bike crossings to provide adequate refuge space for bikes
 - 4' medians can be considered in constrained right of way
 - Medians should include greening when feasible
6. Lane markings should be included and parking lanes should generally be striped

G. Design speed

25 mph

See [design speed guidance](#) for more detail.

H. Design vehicle

Most commonly SU-30 or WB-40 depending on intersecting street and context.

See [design and control vehicles guidance](#) for more details.

I. Control vehicle

Most commonly WB-62 or Aerial Fire Truck Mid Mount 100 depending on intersecting street and context.

See [design and control vehicles guidance](#) for more details.

J. Motor Vehicle Property Access	<ol style="list-style-type: none"> 1. New driveways should generally be limited to locations without alley or cross street access. 2. Designers should explore removing driveways that are no longer being used, are no longer permitted, or where access is provided via an alley. Designers should also explore right-sizing driveway curb cuts. <p>See driveways guidance for more details.</p>
K. Intersection Traffic Control	Signal control
L. Intersection details	Curb extensions should generally be used whenever there is full-time parking.

TYPICAL CROSS SECTIONS

Figure 2.9.1:

One-way Downtown Core street with bus-only lane and two-way protected bike lane (80' effective right of way)

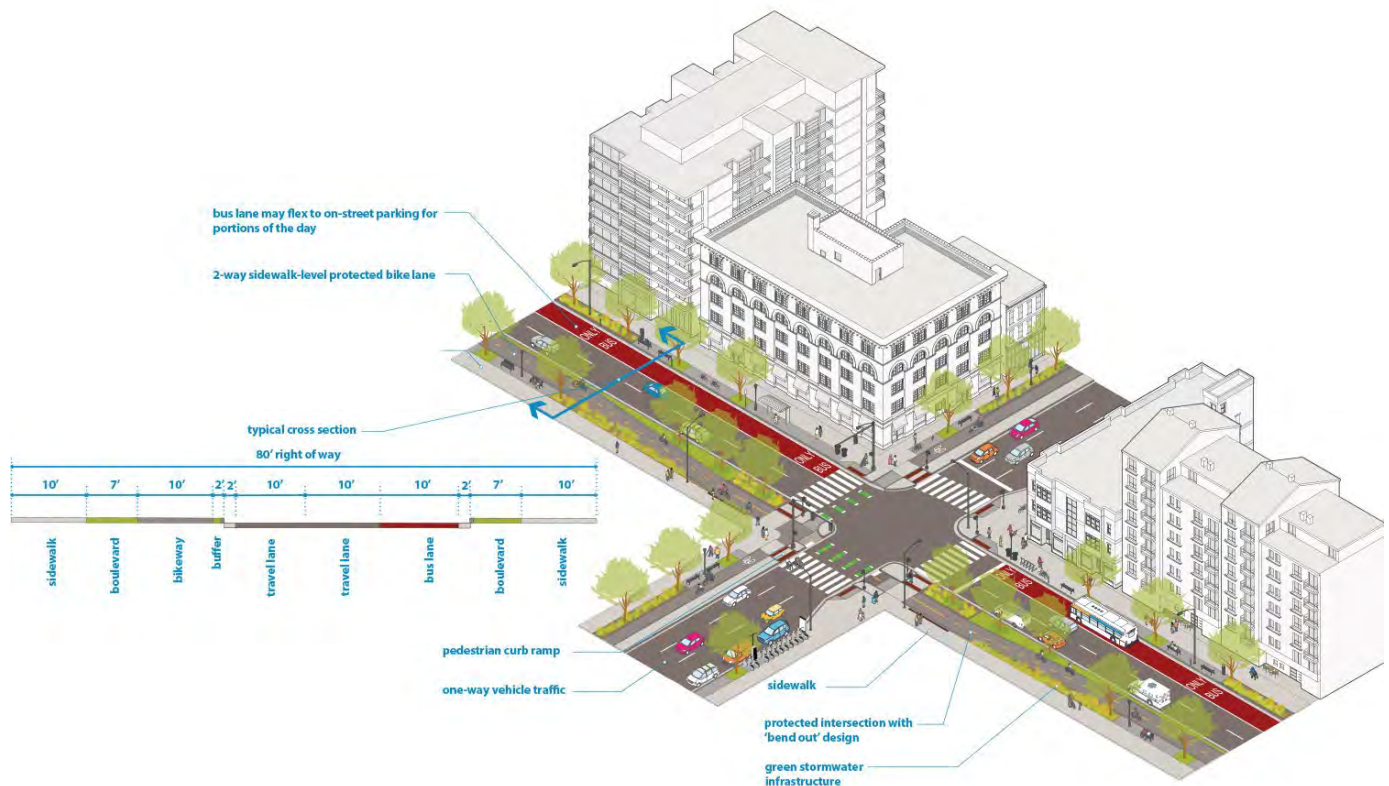



Park land not public right of way, support recreation and access to natural areas and community destinations.

DESCRIPTION

Parkways are under the jurisdiction of the Minneapolis Park and Recreation Board, typically are considered park land not public right of way, and support recreation and access to natural areas and community destinations across Minneapolis. Many parkways fall within the Grand Rounds parkway system, which is an interconnected system of parkways across the city and is eligible for the National Register of Historic Places. Parkway streets were originally planned and designed as linear parks and typically parallel rivers, streams, and lakes. While parkways can be attractive for non-recreational motor vehicle trips, these streets are not intended for through motor vehicle traffic.

Examples include Victory Memorial Parkway, West River Parkway, and Minnehaha Parkway.

TYPICAL CHARACTERISTICS

Miles	53 miles Approximately 5% of total street centerline mileage
Right of Way Width	<ul style="list-style-type: none"> Varies Parkway streets are located on Minneapolis Park and Recreation Board property by fee title
Effective Right of Way	Varies
Functional Class	Local
Jurisdiction	Minneapolis Park and Recreation Board
Route	Local
Modal Network	All Ages and Abilities Bikeway Network
Snow Emergency Route	Not typically
Historic Street	No

TYPICAL DESIGN AND OPERATIONS

See [Street Design Guidance chapter](#) for more information

A. Sidewalk	<ol style="list-style-type: none"> 1. Parkway typically provide one 6'-8' wide pedestrian path in coordination with a trail. The pedestrian path should be separate from the bikeway when possible or part of a shared use path if the separated facilities are not feasible. See trail guidance for more details. 2. A standard sidewalk is typically only included if there is direct private property access: <ul style="list-style-type: none"> » 6' typical pedestrian clear width » 2'+ frontage width to any obstructions <p>See sidewalks guidance for more details.</p>
B. Boulevard and Furnishing	<ol style="list-style-type: none"> 1. 6'+ typical width, including 14" wide curb 2. Parkway regularly include opportunities for ecological function, stormwater capture, placemaking elements like benches and art, wayfinding, and act as ecological corridors. 3. Street trees and landscaped boulevards should be prioritized to support a park environment. See street trees guidance for more details. Wider boulevard and furnishing zones (park space) should be used when feasible to support features that make the pedestrian environment more attractive and comfortable, support tree health, and maximize green stormwater infrastructure. <p>See boulevards and furnishings guidance for more details.</p>
C. Bikeway	<p>For parkways on the All Ages and Abilities bikeway network, see trail guidance for more details. 2-way bikeways or shared use paths should generally be used or 1-way bikeway if 2-way bikeway is not feasible. The trail and roadway can be immediately adjacent or separated by a significant amount of landscape, streams, or topography.</p>
D. Transit	<p>Except for a few locations, public transit is prohibited from parkways.</p>
E. Freight	<p>Not on the Truck Route Network. Trucks and commercial vehicles are prohibited from most parkways.</p>

F. Roadway

1. Parkway design should discourage through motor vehicle trips by limiting access points, creating tighter intersection geometry, and encouraging slow motor vehicle speeds.
2. The roadway includes 1- or 2-way traffic and should be limited to one travel lane in each direction.
3. Standard roadway widths include:
 - » 10' traffic lanes
 - » 1' "stout" gutter pans (unique to parkways); 2' catch basins are still preferred
 - » 7' parking lanes (including gutter pans)
 - » 6' or wider planted median
4. Two-way roadways often include a planted median or divided roadway.
5. Motor vehicle parking can be provided on one side in some areas. Efforts should be made to prioritize green space.
6. Lane markings should not typically be included.
7. Roadway includes unique asphalt red granite chip-seal surface over a compacted base with no concrete.

G. Design speed

25 or 20 mph

See [design speed guidance](#) for more detail.**H. Design vehicle**

Most commonly DL-23, but can also be SU-30 or WB-40 depending on intersecting street and context.

See [design and control vehicles guidance](#) for more details.**I. Control vehicle**

Generally Aerial Fire Truck Mid Mount 100.

See [design and control vehicles guidance](#) for more details.**J. Motor Vehicle Property Access**

Motor vehicle property access is limited along parkways. New driveways should be limited to locations without alley or cross street access. Driveway or access on and off parkways requires a permit from MPRB.

See [driveways guidance](#) for more details.**K. Intersection Traffic Control**

Stop control or signal control

L. Intersection details

1. [Curb extensions](#) should be used whenever there is parking.
2. [Raised pedestrian crossings](#) should be considered if there is a trail, shared use path, or high-volume pedestrian crossing across a parkway.

TYPICAL CROSS SECTIONS

Figure 2.10.1:
2-way Parkway street with trail

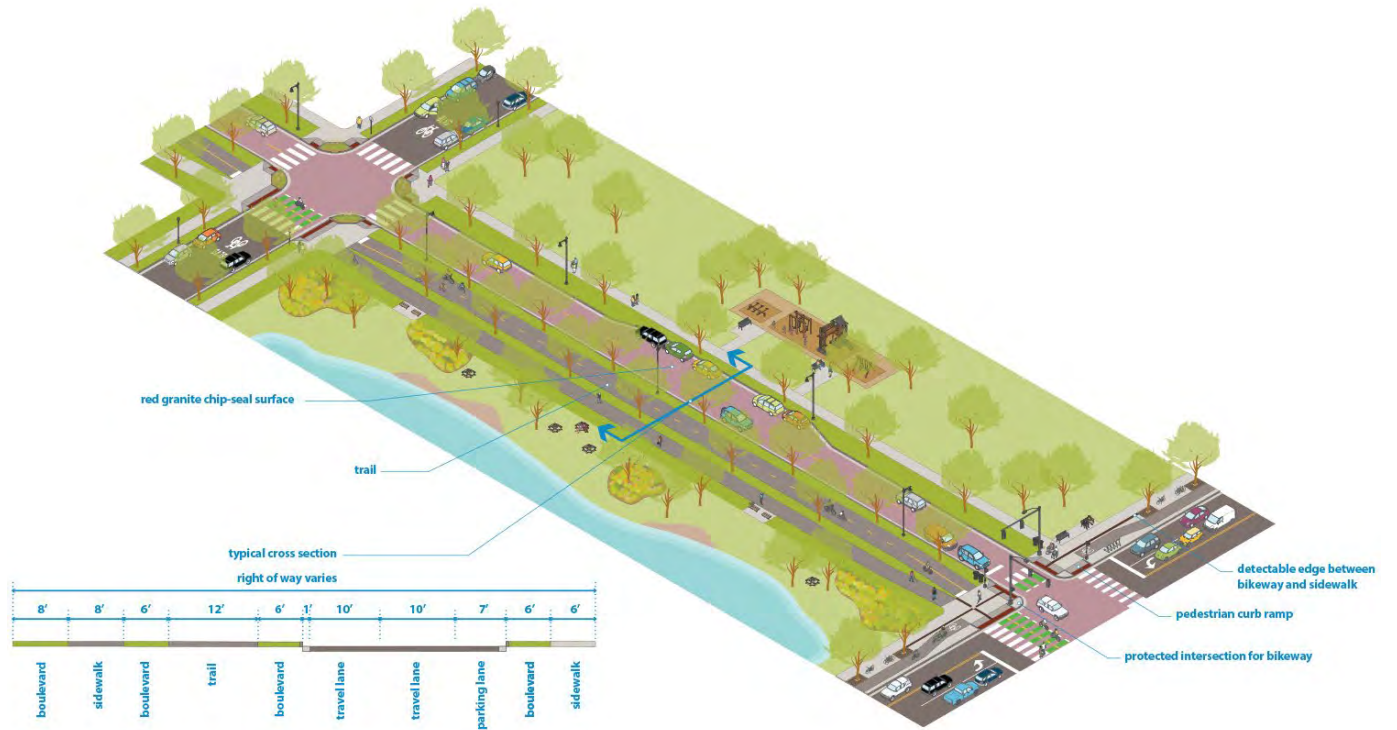

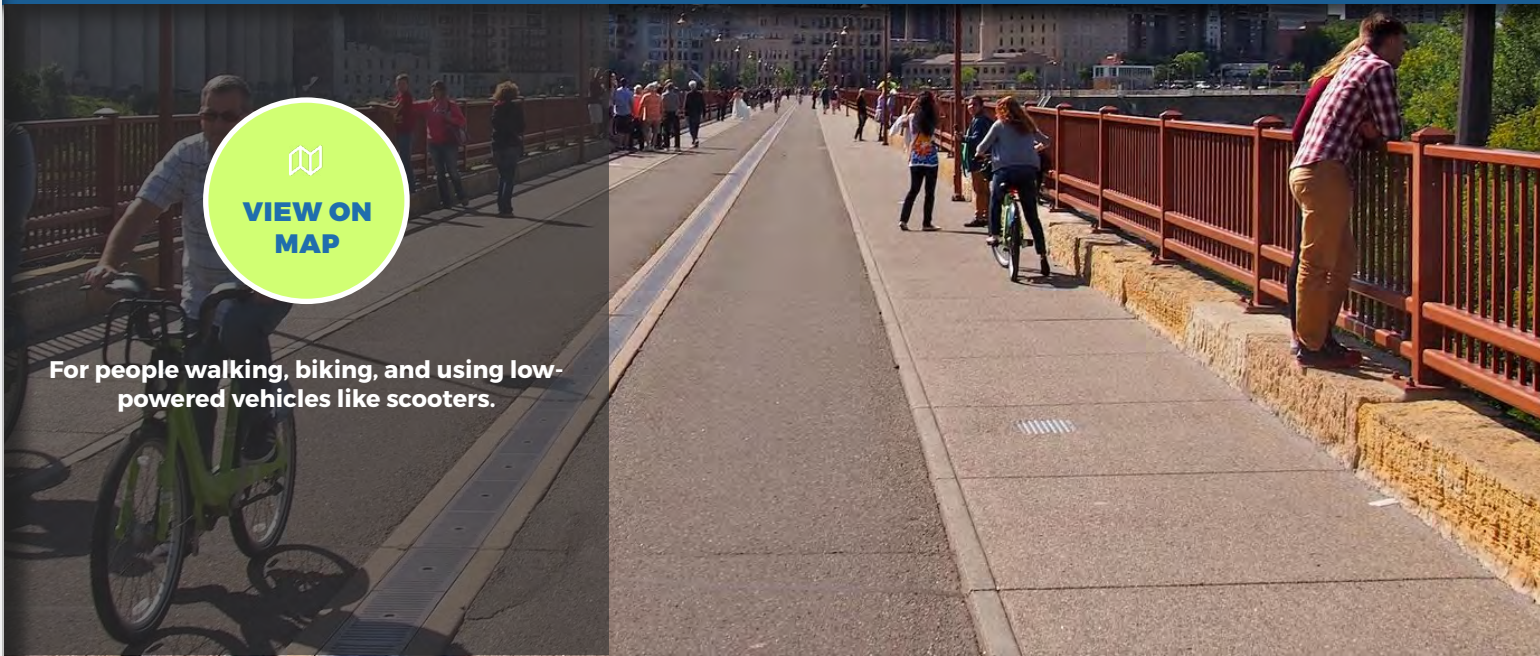

DESCRIPTION

Trails are for people walking, biking, and using low-powered vehicles like scooters. Except for emergency and maintenance vehicles, motor vehicles are prohibited from traveling along trails. Many trails are adjacent to parkways and parallel to rivers, streams, and lakes, while some run along abandoned and active rail or utility corridors. In addition to recreational uses, trails serve an important transportation function for non-motorized users, providing a low-stress environment separate from motor vehicles. See [parkway guidance](#) if trail is adjacent to a parkway.

Examples include the Northeast Diagonal Trail, Cedar Lake Trail, and Midtown Greenway.

TYPICAL CHARACTERISTICS

Miles	-115 miles
Right of Way Width	Varies
Effective Right of Way	Varies
Functional Class	N/A
Jurisdiction	<ul style="list-style-type: none"> • City of Minneapolis • Hennepin County • Minneapolis Park and Recreation Board
Route	N/A
Modal Network	All Ages and Abilities Bikeway Network
Snow Emergency Route	No
Historic Street	No

TYPICAL DESIGN AND OPERATIONS

See [Street Design Guidance chapter](#) for more information

A. Sidewalk

1. 6'-8' typical pedestrian clear width
2. 2'+ frontage width to any obstructions
3. Sidewalk should be separate from the bikeway when possible or use a [shared use path](#) if the separated facilities are not feasible.
4. Sidewalk should typically be made of concrete to provide color differentiation from the adjacent bikeway.
5. Sidewalk and bikeway should be separated with vegetation or with a detectable edge. See [sidewalk-level protected bike lanes guidance](#) for more details on detectable edges.

B. Boulevard and Furnishing

1. 6'+ typical width
2. Trails regularly include opportunities for ecological function, stormwater capture, placemaking elements like benches and art, wayfinding, and act as ecological corridors.
3. Street trees and landscaped boulevards should be prioritized to support an attractive environment and provide a number of other benefits. See [street trees guidance](#) for more details. Wider boulevard and furnishing zones should be used when feasible to support features that make the pedestrian environment more attractive and comfortable, support tree health, and maximize [green stormwater infrastructure](#).
4. Sign posts, lighting, utilities, plantings, and furnishings may be located in the buffer areas, provided a minimum of 2' clearance is maintained from fixed objects to the bikeway operating area, and a minimum of 1.5' clearance is provided from the back-of-curb to the fixed object. Narrower clearance can be used for short stretches in constrained right of way.

See [boulevards and furnishings guidance](#) for more details.

C. Bikeway

1. 2-way trails should be encouraged wherever feasible to support bicycle access and bikeway network connectivity.
2. Sidewalk should be separate from the bikeway when possible or use a [shared use path](#) if the separated facilities are not feasible.
3. 10'-14' typical width for 2-way bikeway generally with striped centerline; 8' minimum width can be used for short stretches in constrained right of way
4. 6'-8' typical width for 1-way bikeway; 4' minimum width can be used for short stretches in constrained right of way; bike symbol should be included at start and end of block
5. Use materials such as asphalt or colored concrete to visually differentiate the bikeway operating area from the sidewalk. The trail materials should be maintained consistently whenever there are driveways or other access points across the bikeway and changes in grades should be minimized as possible as possible.
6. If not adjacent to a roadway, the trail should accommodate emergency and maintenance vehicle access.
7. See the Shared Use Path section of the [MnDOT Bicycle Facility Design Manual](#) (page 5-3) for additional details on trail design.

D. Transit	Transit service not provided, although future transit may be planned within the adjacent right of way
E. Freight	Motor vehicles are prohibited from trails, except for emergency and maintenance vehicles.
F. Roadway	Motor vehicles are prohibited from trails, except for emergency and maintenance vehicles. If trail is adjacent to a parkway or different type of street, see guidance for that street type.
G. Design speed	N/A
H. Design vehicle	N/A
I. Control vehicle	N/A
J. Motor Vehicle Property Access	No private motor vehicle property access from trails. Non-motorized property access should be provided at regular interval to connect to other streets and adjacent land uses.
K. Intersection Traffic Control	Stop control, yield control, or signal control
L. Intersection details	<ol style="list-style-type: none"> Raised pedestrian crossings should generally be included when a trail crosses an Urban Neighborhood street and should be considered when crossing a parkway. See shared use path crossing guidance for additional details on trail design at intersections.

TYPICAL CROSS SECTIONS

Figure 2.11.1:
Trail with separate 2-way bikeway and adjacent pedestrian zone

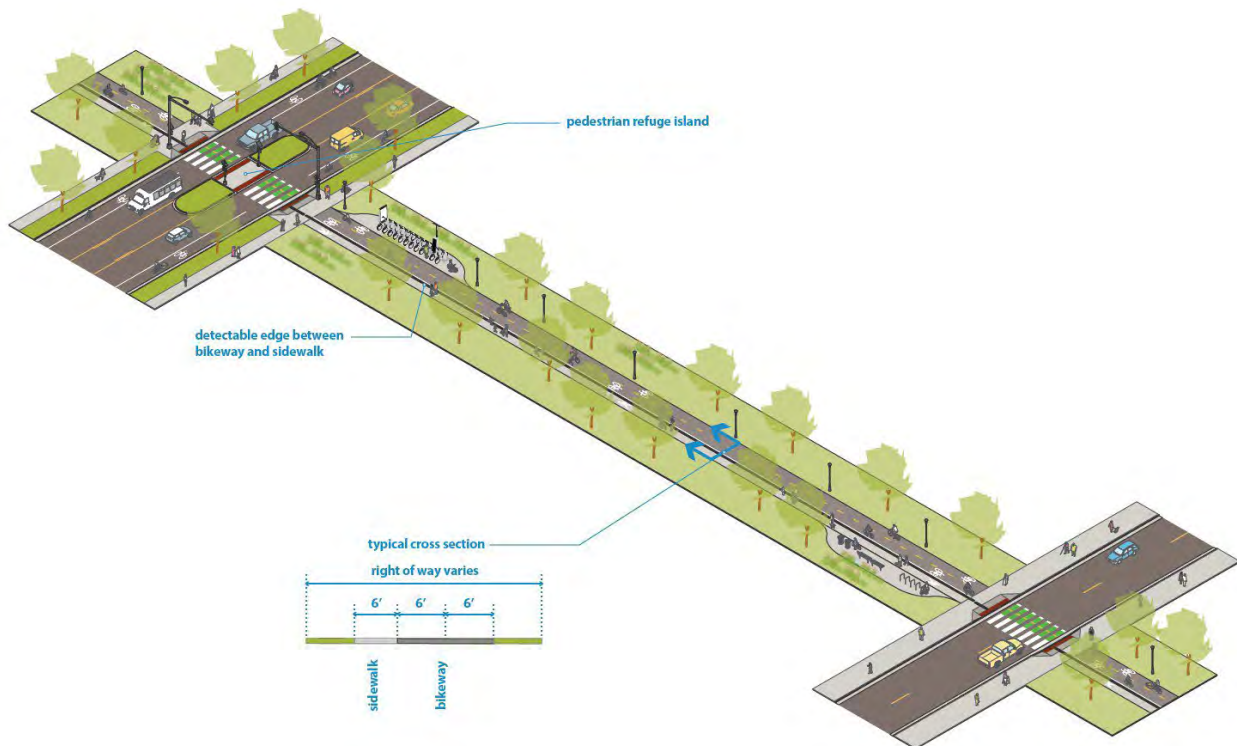

2.12 Alley



Limited use streets that provide property access and primary locations for freight loading and waste collection.

DESCRIPTION

Alleys are limited use streets that provide property access and serve as primary locations for freight loading and solid waste, recycling, and organics collection. Alleys are located throughout the city, most commonly in Urban Neighborhood areas. The street is designed for low speeds of 10 mph or less, where people walking, biking, and driving share space. Alleys are not intended for through traffic and design elements should discourage traveling more than one block.

TYPICAL CHARACTERISTICS

Miles	~426 miles
Right of Way Width	12'-14' on most residential alleys Commercial alleys may be 16' or wider
Effective Right of Way	Typically the same as right of way width
Functional Class	N/A
Jurisdiction	City of Minneapolis
Route	N/A
Modal Network	None
Snow Emergency Route	No
Historic Street	No

TYPICAL DESIGN AND OPERATIONS

See [Street Design Guidance chapter](#) for more information

A. Sidewalk	No dedicated sidewalk. Pedestrians use the shared roadway space.
B. Boulevard and Furnishing	Landscaping is not typically included in alleys, but green stormwater infrastructure may be included as appropriate to treat and/or reduce stormwater runoff.
C. Bikeway	No dedicated bikeway. People bicycling use the shared space.
D. Transit	Transit service not provided.
E. Freight	Not included on the Truck Route Network. Provide access for solid waste, recycling, and organics collection and accommodate frequent loading up to 30 minutes in both residential and commercial alleys, which is allowed per City of Minneapolis ordinance.
F. Roadway	<ol style="list-style-type: none"> 1. One 2-way shared travelway space for pedestrians, bicycles and motor vehicles. 2. Alleys are paved with a v-shaped design to provide for stormwater conveyance from adjacent properties to the City storm water system.
G. Design speed	10 mph See design speed guidance for more detail.
H. Design vehicle	N/A. Typically use 5' curb-return radius. See curb-return radii guidance for more details.
I. Control vehicle	N/A
J. Motor Vehicle Property Access	Serves as a primary loading access for most properties in the city.
K. Intersection Traffic Control	Yield control
L. Intersection details	None

TYPICAL CROSS SECTIONS

Figure 2.12.1:
Residential alley (12' wide)

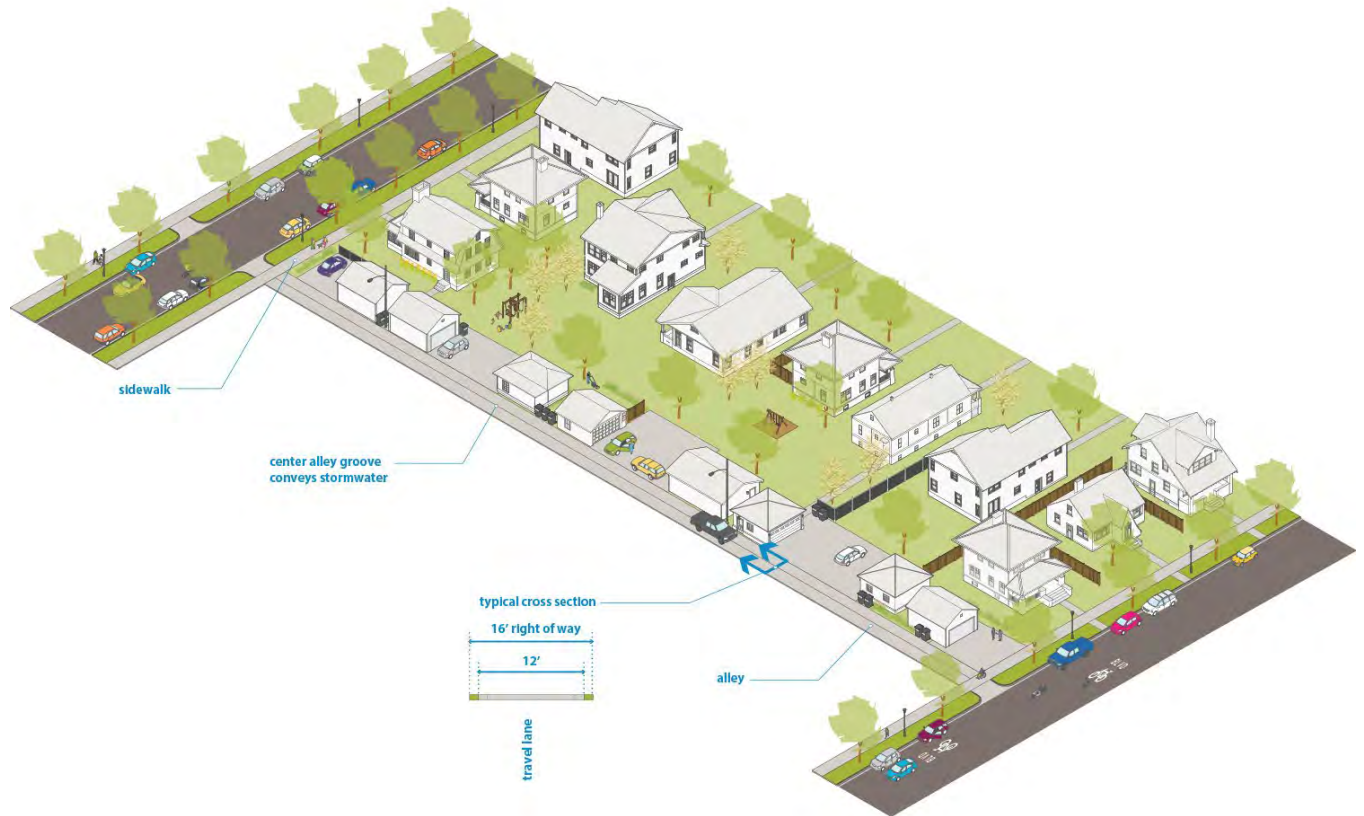



This guidance institutionalizes the City's Transportation Action Plan, Complete Streets Policy, Vision Zero commitment, greenhouse gas emission reduction goal, commitment to racial justice, and stormwater management requirements through the design of the right of way. Street design will reflect these policies and translate them into opportunities for increased health and safety outcomes for everyone and improved walking, biking, transit, and greening.

See the [introduction chapter](#) for additional grounding for this chapter.

The guidance in this chapter is organized by six street zones:

- **3.1 Introduction**
- **3.2 Sidewalks**
 - 3.2A Sidewalks introduction and general guidance
 - 3.2B Sidewalk zone design guidance
 - 3.2C Sidewalk surface design
- **3.3 Boulevards and furnishings**
 - 3.3A Boulevards and furnishings introduction and general guidance
 - 3.3B Curbs
 - 3.3C Greening
 - 3.3D Street Trees
 - 3.3E Green Stormwater Infrastructure
 - 3.3F Utilities and signs
 - 3.3G Street lighting
 - 3.3H Bicycle and micro mobility parking
 - 3.3I Driveways
 - 3.3J Sidewalk cafes
- **3.4 Bikeways**
 - 3.4A Bikeways introduction and general guidance
 - 3.4B Protected bike lanes introduction
 - 3.4C Delineator-protected bike lanes
 - 3.4D Planter-protected bike lanes
 - 3.4E In-street curb-protected bike lanes
 - 3.4F Sidewalk-level protected bike lanes
 - 3.4G Shared use paths
 - 3.4H Neighborhood greenways
 - 3.4I Neighborhood greenways: full greenways
 - 3.4J Neighborhood greenways: bicycle boulevards
 - 3.4K Bike lanes, unprotected
 - 3.4L Buffered bike lanes, unprotected
 - 3.4M Contraflow bike lanes
 - 3.4N Advisory bike lanes
- **3.5 Transit stops**
 - 3.5A Transit stops introduction and general guidance
 - 3.5B Regular-route bus stops
 - 3.5C Bus Rapid Transit stations
 - 3.5D Bus stops and bikeways
- **3.6 Roadways**
 - 3.6A Roadways introduction and general guidance
 - 3.6B Lane widths
 - 3.6C Design speed
 - 3.6D Traffic calming and speed management

3.1 Introduction

- 3.6E Bus-only lanes
- 3.6F In-lane bus stops
- 3.6G Vehicle parking and curbside uses
- 3.6H Medians
- 3.6I Historic streets
- **3.7 Intersections**
 - 3.7A Intersections introduction and general guidance
 - 3.7B Design and control vehicles
 - 3.7C Curb-return radii
 - 3.7D Pedestrian crossings
 - Sidewalk visibility
 - Curb ramps
 - Marked crosswalks
 - Curb extensions
 - Advanced Stop bars
 - Raised pedestrian and bicycle crossings
 - Pedestrian and bicycle safety islands
 - 3.7E Bikeway intersection design
 - Protected intersections
 - Shared Use Path crossings
 - Two-way bikeway transitions
 - Bike lane retrofit projects with mixing zones
 - Bike lanes at t-intersections
 - Bicycle boxes
 - Bicycle detection at signalized intersections
 - 3.7F Traffic circles



Building and maintaining attractive and accessible sidewalk zones plays an essential role in reaching City goals to support and promote walking and rolling.

SIDEWALKS INTRODUCTION AND GENERAL GUIDANCE

Building and maintaining attractive and accessible sidewalk zones plays an essential role in reaching City goals to support and promote walking and rolling. The Minneapolis [Complete Streets policy](#) establishes a modal framework that prioritizes serving the needs of people walking and rolling first when planning for our transportation system and streets. The Minneapolis [Transportation Action Plan](#) includes strategies to promote a safe and inviting walking and rolling environment and support increasing the share of trips made by walking from 15% in 2010 to 25% in 2030.

ACCESSIBILITY

The Americans with Disabilities Act (ADA) prohibits discrimination on the basis of disability and mandates equal opportunity for individuals with disabilities. The City of Minneapolis follows the most recent [2010 ADA Standards for Accessible Design](#) and looks to [Proposed Guidelines for Pedestrian Facilities in the Public Right of way \(PROWAG\)](#) for guidance on how to supplement the 2010 ADA Standards. Key elements from those standards are included in this sidewalk guidance to ensure accessibility.

INCLUSION OF SIDEWALKS

Sidewalks should generally be included on both sides of any newly constructed street. Streets that may require sidewalks on only one side of the street include:

A street **without any local access on one side**, such as adjacent to a freeway or cemetery; and

A street with **severe topographic constraints** that make installing a sidewalk prohibitively challenging.

Development projects should include construction of a continuous sidewalk system adjacent to the development and connecting to the existing sidewalk system in line with guidance. This may require sidewalk construction beyond the property frontage or on an adjacent block.

PEDESTRIAN PRIORITY NETWORK

The **Pedestrian Priority Network** is a grid of streets that represent where people most frequently walk and often includes access to transit and commercial and regional destinations. The Pedestrian Priority Network is the focus of planning, design, operations, and maintenance to improve the ease, comfort, and safety of people walking throughout the year. (Note that a separate network of sidewalks is prioritized for clearing snow from corners.)

Streets on the Pedestrian Priority Network should typically include wider pedestrian zones, frequent high-quality pedestrian crossings, and more pedestrian-oriented street amenities. Streets not on the Pedestrian Priority Network should be designed with pedestrian needs in mind in accordance with the Complete Streets Policy.

ELEMENTS OF THE SIDEWALK ZONE

The sidewalk zone is one of three street zones. The sidewalk zone is typically located directly adjacent to the edge of the public right of way. Sidewalks serve as the backbone of the pedestrian network and support access between private property and streets. Sidewalks are for people to walk or gather. Bicycles may use the sidewalk zone in limited locations outside of business districts or where shared use paths are present. Motor vehicles also may need to travel across the sidewalk zone to access private property via driveways or alleys.

The sidewalk zone is divided into three main subzones: frontage zone, pedestrian clear zone, and boulevard and furnishing zone, which are described below. There are also three additional specialty subzones that overlap with the sidewalk zone: the clear corner zone, the corner public use zone, and the bus stop zone (see Figure 3.2A.1).

Figure 3.2A.1:

Sidewalk zones and specialty zones



Frontage Zone

The frontage zone is located immediately adjacent to the edge of the public right of way. This zone provides space for street users to access land uses and serves as a buffer between the pedestrian clear zone and buildings, structures, or elevation changes. Potential uses in the frontage zone include landscaping, transit shelters, retail displays, sidewalk cafes, or other features that make the pedestrian environment more attractive. Along streets with commercial uses, consideration should be given to space for sidewalk cafes in the frontage zone in accordance with [Process and Criteria for Sidewalk Café Licenses](#).

Pedestrian Clear Zone

The pedestrian clear zone is located between the frontage zone and boulevard and furnishing zone. This zone provides space for pedestrians to travel along streets and must be kept clear of obstructions, vertical discontinuities (e.g. manhole or utility covers that protrude up), slippery surfaces (e.g. tree grates or other slick metal), and non-compliant cross slopes. The pedestrian clear zone serves as the Pedestrian Access Route, as defined by the Americans with Disability Act of 1990. The Pedestrian Access Route ensures a minimum passable space for those using mobility devices such as wheelchairs and provides predictability for those using other devices such as canes.

Boulevard and Furnishing Zone

The boulevard and furnishing zone is located between the pedestrian clear zone and bikeway zone or roadway zone. This zone provides space for many activities: space for pedestrians to gather or wait for transit, trees, landscaping, greening, furnishings, signs, wayfinding, streetlights, street signal infrastructure, utility cabinets, bicycle and scooter parking, charging stations for electric vehicles, and the curb. This zone also provides separation from people walking and motor vehicles.

Sidewalk specialty zones

Clear corner zone. The clear corner zone is an obstruction-free space between the curb and the lines created by extending the inside sidewalk line to the curb face. Priority use of the clear corner zone shall be for accessible **curb ramps**, accessible pedestrian signals, and other pedestrian call buttons.

Corner public use zone. The corner public use zone is the portion of the boulevard and furnishing zone immediately adjacent to the clear corner zone generally designated for public **utilities and signs**, including fire hydrants, traffic signals, streetlights, and service cabinets.

Bus stop zone. The bus stop zone is the area behind the curb which provides access to buses, waiting space and facilities for bus passengers, as well as through walk access. See guidance on **transit stops** for more details.

3.2B Sidewalk zone design guidance



Guidance for the sidewalk zone varies by street type to account for the varying contexts throughout the city.

SIDEWALK ZONE DESIGN GUIDANCE

Guidance for the sidewalk zone varies by **street type** to account for the varying contexts throughout the city (see Figure 3.2B.1). The sidewalk guidance provides flexibility to address the range of most streets in Minneapolis, although there still may be unique situations that require adjustments from the guidance. Accessibility requirements are required by the Americans with Disabilities Act and must be met on all projects.

Figure 3.2B.1:
Sidewalk zone widths by street type



Street Type	Frontage Zone	Pedestrian Clear Zone	Boulevard and Furnishing Zone
Urban Neighborhood	2' +	6'	5' +
Urban Neighborhood Connector	2' +	6'	5' +
Production and Processing	2' +	6'	5' +
Mixed Use Community Connector	2' +	6' to 8'	5' +
Mixed Use Commercial Connector	2' +	6' to 10'	6' +
Mixed Use Regional Connector	2' +	6' to 8'	8' +
Downtown Core	2' +	8' to 10'	6' +
Parkway	2' +	6' to 8'	6' +

Constrained minimums

See sidewalk zone design considerations

Preferred widths shown – see sidewalk zone design considerations for more detail

DESIGN CONSIDERATIONS

A. Frontage Zones

1. The frontage zone width is the clearance to any obstructions such as doors or fences that would impede into the pedestrian clear zone.
2. Recommended width. 2' or wider frontage zones are recommended for all street types.
3. Constrained minimum widths.
 - i. Where there are doors or gates opening into the sidewalk zone, a minimum frontage of 1.5' is generally required. In rare situations with constrained right of way, narrower can be considered.
 - ii. Where there are no doors or gates opening into the sidewalk zone, no frontage zone is required.
4. Stairs, ramps, and doors. Impacts to the pedestrian right of way from private entryways should be limited to the frontage zone. One method to mitigate the potential impacts from new development is by recessing entryways. During sidewalk reconstruction, the new sidewalk, while following ADA standards, should be constructed to avoid conflict between opening doors and the sidewalk surface. Stairways, including railings, should not extend into the pedestrian clear zone.
5. Wider frontage zones. Wider frontage zones should be considered when appropriate to support [transit shelters](#), [sidewalk cafes](#), retail displays, landscaping, or other features that make the pedestrian environment more attractive.
6. Sidewalk cafes. Active uses of the sidewalk zone such as sidewalk cafes can substantially improve the walking environment; however, it is necessary to balance their placement with the need to maintain the pedestrian clear zone. See also [sidewalk cafes guidance](#).
7. Commercial signs. Commercial signs extending more than 6' from a building over public right of way should be hung so that there is at least 8 feet of vertical clearance above the sidewalk. See also Minneapolis City Code of Ordinances [Chapter 543 On Premise Signs](#).

C. Pedestrian clear zone

1. Recommended widths. Figure 3.2B.1 includes recommended pedestrian clear zone widths for all street types. 6'-or wider for some street types—pedestrian clear zones are recommended for all streets.
2. Constrained minimum widths. When necessary in very constrained situations, point obstructions such as poles and fire hydrants may encroach into the pedestrian clear zone, although every effort should be made to retain at least 5' of pedestrian clear space. The unobstructed pedestrian clear zone must always be at least 4' wide to meet ADA accessibility requirements.
3. Separation from roadway. Pedestrian clear zones should generally not be directly adjacent to the roadway except on very rare extremely constrained Urban Neighborhood or Production and Processing streets. The boulevard and furnishing zone also provides separation between people walking and motor vehicles.
4. Space for greening. Narrowing the pedestrian clear zone width to 5' can be considered in some cases if needed to accommodate a tree-supporting boulevard or to address critical flooding concerns/green stormwater infrastructure needs. Every effort should be made to narrow the roadway to accommodate before narrowing the pedestrian clear zone. Narrowing the pedestrian clear zone width below 6' should not be done on Downtown Core streets, Mixed Use Regional Connectors, or on many Mixed Use Commercial Connectors with high pedestrian demand.
5. Wider pedestrian clear zones. In areas with higher pedestrian demand, wider pedestrian clear zones can be considered, although in most situations additional space for the boulevard and furnishing zone should be prioritized over wider pedestrian clear zone to provide space for greening and furnishings that improve the pedestrian experience.
6. Objects in the pedestrian clear zone. Wall or post mounted objects placed between 27 and 80 inches above the walking surface may not extend more than 4 inches horizontally to prevent hazards for people with vision impairments (see Figure 3.2B.2).

Figure 3.2B.2:

Pedestrian clear zone vertical clearance requirements

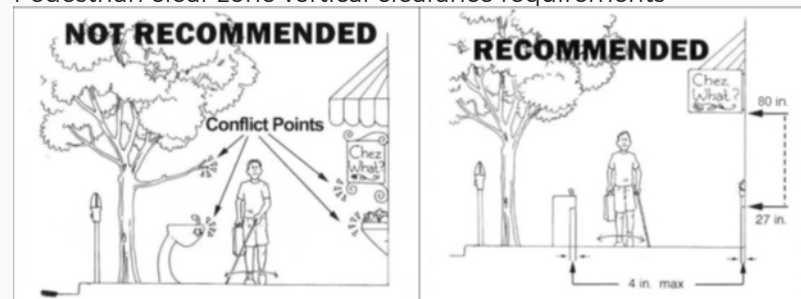

D. Boulevard and furnishing zone

1. Recommended widths. Figure 3.2B.1 includes recommended boulevard and furnishing zone widths for all street types. 5+ or wider boulevard and furnishing zones are recommended for all street types.
2. Wider when feasible. Wider boulevard and furnishing zones should be used when feasible to support features that make the pedestrian environment more attractive, support tree health, and maximize green stormwater infrastructure.
3. Constrained minimum widths.
 - » [Street trees](#) need at least 4' width of soil, so a 5' boulevard and furnishing zone is required to support small street trees alongside the adjacent [curb](#).
 - » Streetlights generally require at least 3' of space, including a minimum clearance of 1.5' from the back of curb. See [streetlight guidance](#) for additional detail.
 - » The constrained minimum width between a protected bikeway and pedestrian clear zone is 0.5', although 1' or wider is preferred. See [sidewalk-level protected bike lane guidance](#) for additional detail.
4. See also guidance for [boulevards and furnishings](#), [transit stops](#), and [sidewalk-level protected bike lanes](#).

E. Combined sidewalk zone width

1. The combined width of the sidewalk zone (including frontage zone, pedestrian clear zone, and boulevard and furnishing zone) should generally be 13'-18' or more depending on context and street type as shown in Figure 3.2B.1.
2. In rare, very constrained situations where every consideration has been taken to narrow all other street zones, a sidewalk zone as narrow as 6' can be considered.

F. Placement of elements in the sidewalk zone

1. There are many elements that typically need to be placed in the sidewalk zone. These elements need to be organized in a manner that ensures pedestrian accessibility, accommodates the functional requirements for utilities and traffic control, promotes safety and visibility, and makes the most efficient use of the right of way for the many competing needs within the sidewalk zone.
2. See Figure 3.2B.3 for guidance on the placement of common elements within the sidewalk zone.
3. The clear corner zone (see Figure 3.2A.1) should be limited to accessible [curb ramps](#), accessible pedestrian signals, and other pedestrian call buttons when feasible. All other uses should generally be placed outside of the clear corner zone in the corner public use zone or boulevard and furnishing zone. Surface level elements such as manhole covers, utility vault covers or signal handholes should be kept out of the clear corner zone to the greatest extent possible.
4. The corner public use zone (see Figure 3.2A.1) should generally be designated for public [utilities and signs](#), including fire hydrants, traffic signals, streetlights, and service cabinets. This space should generally not be used for furnishings or private temporary uses such as sidewalk cafes, newspaper vending machines, or street vendors.

3.2B Sidewalk zone design guidance

Figure 3.2B.3:

Recommended placement of utilities and furnishings in the sidewalk zone

Element "R" = recommended placement "A" = acceptable placement in constrained conditions	Primary Zones			Private Property	Specialty Zones				Notes
	Boulevard/ Furnishing	Pedestrian clear	Frontage		Clear Corner	Corner Public Use	Bus Stop		
							Front Door	Back Door	
Areaway Covers/Grates	A	A	A	R			A	A	See sidewalk surface design
Benches	R		R	R					
Bicycle Lockers/Shelters	R			R					
Bicycle Racks & Scooter Parking	R		R	R					See bicycle and micro mobility parking
Bus Shelters	R		R	A					See transit stops
Bus Stop Signs	R					R			See transit stops
Fences and Railings				R					
Fire Hydrants	R					R			See utilities and signs
Greening	R		A	R					See greening
Green Stormwater Infrastructure	R		A	A					See green stormwater infrastructure
LRT Catenary Poles	R					R			
Mailboxes	R		A	A					
Newspaper Boxes & Corrals	R		R	R					
Parking Meters	R								See utilities and signs
Pedestrian Signal Push Buttons					A	R			See utilities and signs
Public Art	R		R	R					
Signal Service Cabinets	R		A			R			See utilities and signs
Signal Poles	R					R			See utilities and signs
Streetlights	R					R			See street lighting
Street Signs	R					R			See utilities and signs
Surface Covers (Manholes, Utility Vaults, Signal Hand Holes)	R	A	A		A	R	A	A	See sidewalk surface design
Trees	R		A	R					See street trees
Trash Receptacles	R		A	R		A			See utilities and signs
Utility Poles	R		A	A		R			See utilities and signs
Wayfinding kiosks	R		A	A					

The pedestrian clear zone should provide a safe and accessible surface for walking, rolling wheelchairs or other assistive devices, and people using walkers, crutches, walking canes, and strollers.

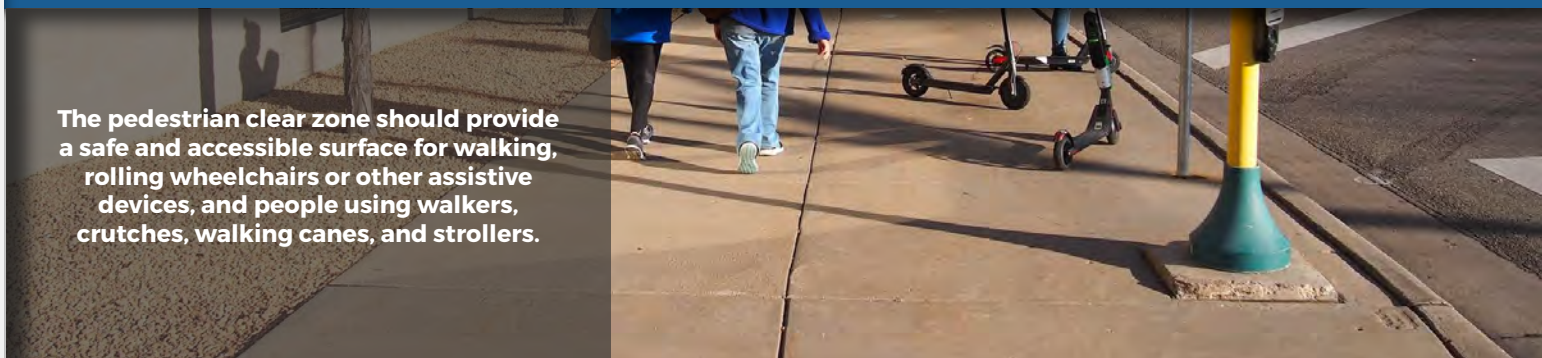

SIDEWALK SURFACE DESIGN

The pedestrian clear zone should provide a safe and accessible surface for walking, rolling wheelchairs or other assistive devices, and people using walkers, crutches, walking canes, and strollers. Sidewalks should be level, firm, stable and slip resistant and avoid excessive vibrations for wheelchair users.

DESIGN CONSIDERATIONS

A. More detail

The [Special Provisions for the Construction of Concrete Sidewalks, Curb and Gutter, Alleys and Drive Approaches](#) and latest addition of [Standard Supplemental Specifications for the Construction of Public Infrastructure](#) provide the detailed standards for sidewalk surface design.

B. Material

1. The standard sidewalk material in Minneapolis is concrete pavement. Enhanced paving can be considered in rare situations, although is generally not used because of negative impacts on ADA access and maintenance.
2. Typical sidewalk panel sizes are 6 x 6 feet. Larger panel sizes generally ensure a more comfortable and accessible surface for all pedestrians. Smaller decorative pavers can be considered on the edges of the pedestrian clear zone in rare situations; ADA accessibility and maintenance challenges must be considered.

C. Surface discontinuities

1. Surface discontinuities (from manholes, valve covers, etc.) may not exceed $\frac{1}{2}$ inch maximum (openings should not permit the passage of a $\frac{1}{2}$ inch sphere), and vertical discontinuities between $\frac{1}{4}$ and $\frac{1}{2}$ inch maximum must be beveled with a slope not steeper than 50 percent (PROWAG R302.7.2), as shown in Figure 3.2C.1.
2. Mn/DOT standard specifications require that joints between panels be formed with a $\frac{1}{4}$ inch rounding tool and that sidewalk surfaces be constructed with a maximum $\frac{3}{16}$ inch variation in surface over a 10 foot plane.

Figure 3.2C.1: Vertical surface discontinuities



Source: [PROWAG 2011](#)

D. Grates that serve as walkable surface

- » Tree grates should generally be discouraged, although they may be necessary in some constrained environments with need for pedestrian space. See [green stormwater infrastructure](#) and [street tree guidance](#) for more detail.
- » Openings in grates should not allow the passage of a ½ inch sphere and should be oriented so that the long dimension is perpendicular or diagonal to the dominant direction of travel.
- » Grates should be built to be slip resistant and have a contrasting color.
- » Grates should be built to be strong enough to withstand vehicles.

E. Sidewalk grades

- » The cross slope of walking surfaces must be no greater than 2% as required by 2010 ADA Standards. Cross slope is the slope of the sidewalk perpendicular to the direction of travel.
- » To achieve an acceptable cross slope in locations with exceptional topographic conditions, the boulevard and furnishing zone and frontage zone may have a steeper cross slope as long as the 2% cross slope is maintained for the minimum pedestrian clear zone width. Allow enough space for the opening of parked car doors. The exception to this design is at transit stops, which require a level loading area.
- » The running slope of walking surfaces must be 5% or less or follow the street grade in line with PROWAG guidance. Running slope measures the grade of the surface along the direction of travel.

Figure 3.2C.2: Sidewalk cross slope

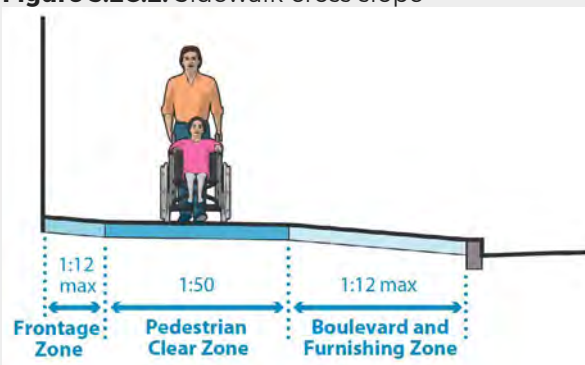

F. Intersection with driveways and alleys

- » The width and grade (not greater than 2% cross slope) of the pedestrian clear zone should generally continue across driveways and alleys whenever possible.
- » In rare very constrained conditions, the pedestrian clear zone width may be reduced to 4' by driveways or alleys, and the sidewalk may be jogged away from the roadway to accommodate proper cross slope.

See [driveways guidance](#) for additional details.

G. At-grade railroad crossings

- » Continuous sidewalk with a firm and stable surface should be provided at railroad crossings wherever possible.
- » Openings for wheel flanges at pedestrian crossings of railroad tracks should be designed to prevent wheelchair wheels from becoming stuck in the tracks.
- » The boulevard and furnishing zone should generally be carried across the railroad crossing to separate the street crossing from the pedestrian crossing and prevent vehicles from driving on the sidewalk; this is particularly important at multitrack railroad crossings where crossings are long.

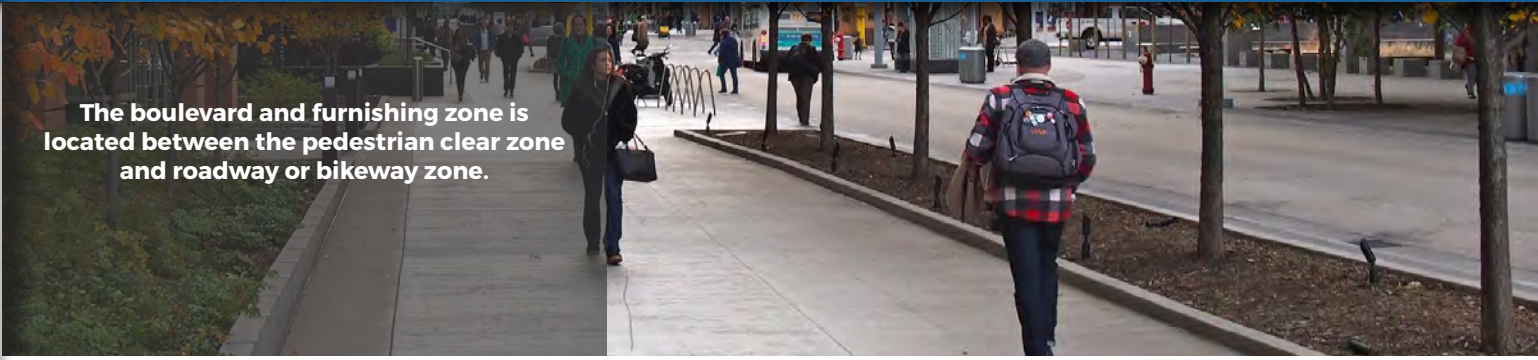

The boulevard and furnishing zone is located between the pedestrian clear zone and roadway or bikeway zone.

3.3A BOULEVARDS AND FURNISHINGS INTRODUCTION AND GENERAL GUIDANCE

The boulevard and furnishing zone is located between the pedestrian clear zone and roadway or bikeway zone. This zone provides space for many activities: space for pedestrians to gather or wait for transit, trees, landscaping, greening, furnishings, sidewalk cafes, signs, wayfinding, street lights, street signal infrastructure, utility cabinets, carriage walks, bicycle and scooter parking, charging stations for electric vehicles, and the curb. This zone also provides separation from people walking and motor vehicles.

Designing green and vibrant streets

The boulevard and furnishing zone is critical for providing space for greening and for creating spaces within the public right of way that are inviting, that encourage people to linger and enjoy the city where they live, work, or play. The Minneapolis Transportation Action Plan includes strong policy to promote green, vibrant streets.

Boulevard and furnishing zone widths

Recommended widths of the boulevard and furnishing zone are included in the [sidewalk zone design guidance](#). Wider boulevard and furnishing zones should be used when feasible to support features that make the pedestrian environment more attractive, support tree health, and maximize green stormwater infrastructure.

Curbs are generally included along all roadways and are part of the boulevard and furnishing zone.

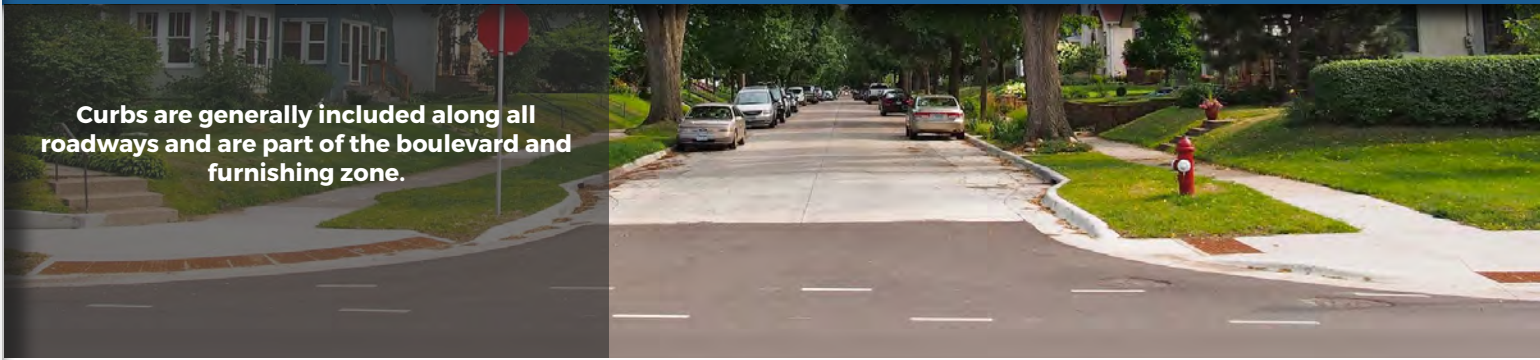

INTRODUCTION

Curbs are generally included along all roadways and are part of the boulevard and furnishing zone. The curb is connected with the gutter, which is covered in the [roadways guidance](#).

6" curb tops (8" total width) are most common in Minneapolis. 12" curb tops (14" total width) are most common in downtown and are used on parkways (often with 1' gutter pans). See Figure 3.3B.1 and Figure 3.3B.2 for details for each curb.

Figure 3.3B.1:
B624 curb with 6" top

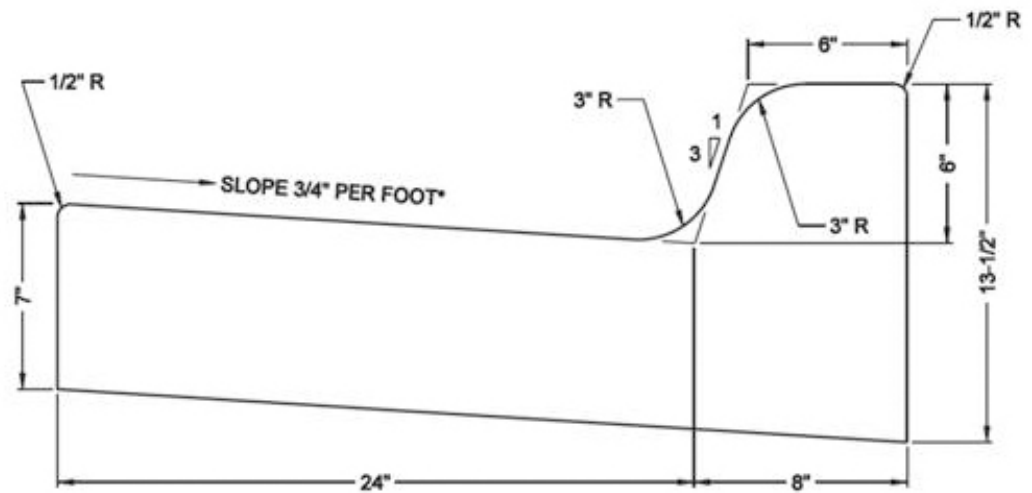

*SLOPE NOT TO EXCEED 1:20 AT CURB RAMPS

Figure 3.3B.2:
B624 Modified curb
with 12" top

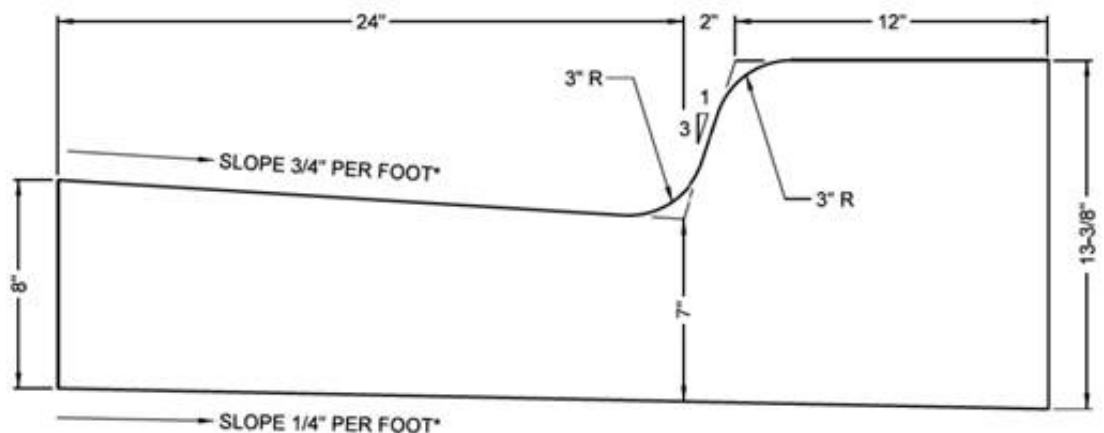

*SLOPE NOT TO EXCEED 1:20 AT CURB RAMPS

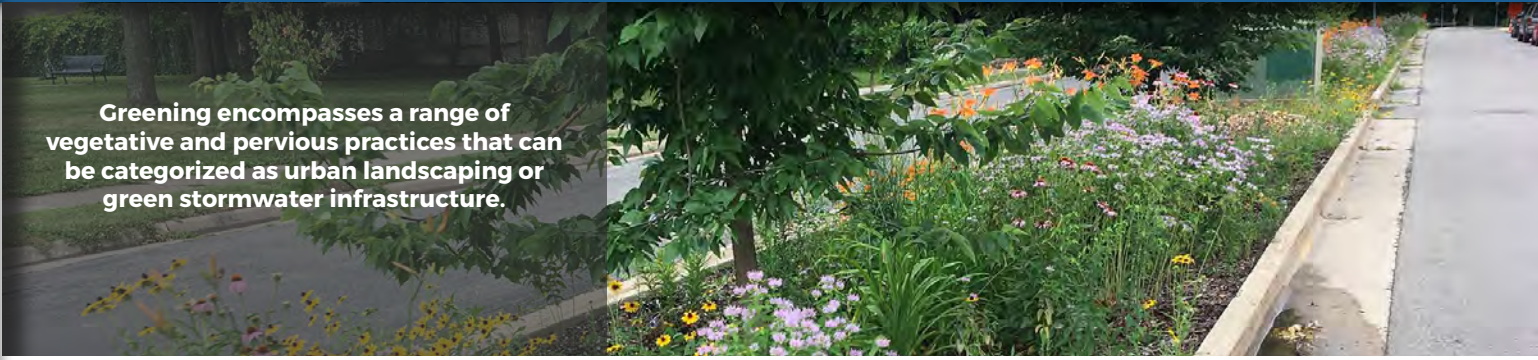

Greening encompasses a range of vegetative and pervious practices that can be categorized as urban landscaping or green stormwater infrastructure.

INTRODUCTION

Greening encompasses a range of vegetative and pervious practices that can be categorized as urban landscaping, such as [street trees](#), grass, and other plantings, or [green stormwater infrastructure](#), which additionally provide stormwater management benefits.

Green the streets is a strategy in the Transportation Action Plan that helps guide this guidance. Greening brings life to the street, capture carbon from the air, reduce heat island effects, and provide critical stormwater management function to reduce localized flooding and improve water quality. The City will seize opportunities as we make improvements to streets to increase functional and aesthetic street treatments that contribute to climate benefits in the city. Functional elements treat and/or contain stormwater before entering the larger stormwater network (see [green stormwater infrastructure guidance](#)). Urban landscaping includes public realm improvements like plantings, boulevards, and trees that help contribute to a sense of place.

DESIGN CONSIDERATIONS

A. Space for greening

More space for greening should be provided whenever feasible while balancing other demands for the street. In most cases, designers should make every effort to include at least 5' of space on both sides of the street to support healthy street trees and green stormwater infrastructure. If needed, these strategies should be considered, in combination as needed, to support healthy trees on both sides of the street:

- » Eliminating parking from one side of the roadway;
- » Provide midblock curb extensions to provide space for trees in between pockets of parking spaces (see Figure 3.3C.1);
- » Narrowing the roadway width slightly below recommended typical;
- » Narrowing the pedestrian clear width to 5' can be considered in some street types if needed to accommodate a tree-supporting boulevard or to address critical flooding concerns/green stormwater infrastructure needs. Every effort should be made to narrow the roadway to accommodate before narrowing the pedestrian clear zone. Narrowing the pedestrian clear width below 6' should not be done on Downtown Core streets, Mixed Use Regional Connectors, or on many Mixed Use Commercial Connectors with high pedestrian demand.

B. Prioritize trees and green stormwater infrastructure

[Street trees](#) and [green stormwater infrastructure](#) should generally be prioritized over other types of greening given their multiple benefits.

3.3C Greening

Figure 3.3C.1:

Midblock curb extension in parking lane to provide space for greening



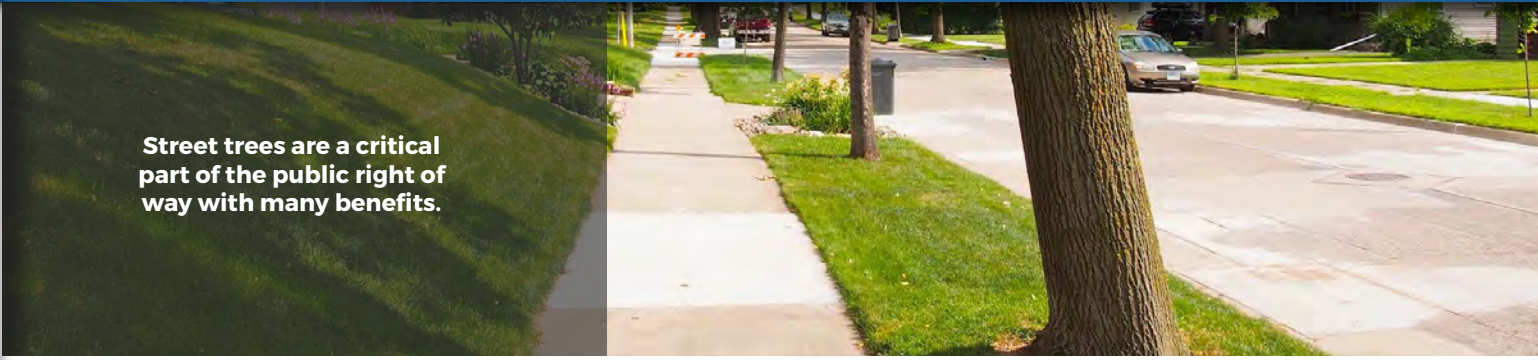

Street trees are a critical part of the public right of way with many benefits.

INTRODUCTION

Street trees are a critical part of the public right of way with many benefits. The Transportation Action Plan includes [Design Action 4.5](#): Increase the tree canopy and urban forest coverage by 2040 by working with the Minneapolis Park and Recreation Board to preserve and enhance trees in the City's right of way. Prioritize coverage where it least exists and in areas of concentrated poverty with majority people of color.

Figure 3.3D.1:

Tree planting guidelines

Boulevard width

Boulevard Width	Tree size
5' or wider	Large tree
From 4' to 5'	Small tree
Less than 4'	No room for a tree

Minimum distance from tree (on center) to existing element

Element	Minimum Distance	Element	Minimum Distance
Cross street (approaching corner)	40'	Cross street (non-approaching corner)	20'
Stop sign, traffic signal	20'	Street light base	12'
Pedestrian level light base, utility pole, fire hydrant	10'	Crosswalk	7'
Alleys, driveway, pedestrian walkway (width)	6'	Bike rack, news rack, trash can, utility box, transit shelter, parking meter	5'
Building facade	4'	Street curb, building entrance or doorway	2'
Loading zone, bus stop	Clear zone		

DESIGN CONSIDERATIONS

A. Prioritize street trees	Designers should make every effort to provide space for street trees on both sides of the street whenever feasible balancing other demands for the street. See greening guidance for strategies to consider for constrained corridors.
B. Space needed for street trees	5' or wider of unpaved boulevard is needed for large tree species and 4'-4.9' is needed for small tree species. See Figure 3.3D.1 for additional details on distance requirements for street trees.
C. Tree trenches	A tree trench is a bioretention facility that includes a tree planted within engineered soil that is designed to store stormwater runoff and allow water to flow through the system and irrigate the tree. Tree trenches should be encouraged and can work with all types of street trees used in Minneapolis. See green stormwater infrastructure guidance for more details.
D. Tree grates discouraged	Tree trenches or other greening should be used around street trees whenever possible. Tree grates should be discouraged because they reduce tree health, require significant maintenance, and cannot serve as accessible pedestrian space. Tree grates may be necessary in some constrained environments with need for pedestrian space.
E. Tree species	The MPRB Forestry Preservation Coordinator determines tree species. If questions, contact: forestry@minneapolisparcs.org .
F. MPRB Forestry	Additional guidance for is available by contacting the MPRB Forestry Preservation Coordinator. MPRB is responsible for the installation and maintenance of all street trees.
G. Additional guidance	Additional guidance, policy, and standards are available: <ul style="list-style-type: none"> » See "ROW Tree Planting" section of current Standard Supplemental Specifications » Urban Forest Policy

Green stormwater infrastructure includes a range of stormwater management features that capture, infiltrate, and clean stormwater runoff.

INTRODUCTION

Green stormwater infrastructure (GSI) in transportation networks includes a range of stormwater management features such as bioretention, bioswales, and permeable pavement, which mimic natural hydrologic conditions. These features capture, infiltrate, and clean stormwater runoff, while maximizing benefits of green space in the transportation corridor.

GSI is a subset of greening. The broader term of greening can include many types of built features that provide greenspace, reduce stormwater runoff, and enhance ecological habitat. While urban landscaping provides some of these benefits by using street trees, grass, and other plantings, GSI provides these benefits through features that are specifically designed to:

Capture and manage stormwater runoff from tributary drainage areas,

Reduce the peak flow or volume of stormwater, and / or

Remove pollutants and sediment.

By incorporating GSI into the planning and design process, a project will be able to:

- Meet State, City, and, where applicable, watershed organizations' stormwater management requirements.
- Reduce localized flooding for safer, more resilient, and greener neighborhoods.
- Reduce runoff volume and rate entering storm sewer and receiving waters.
- Calm traffic and beautify the urban landscape.
- Remove pollutants from stormwater runoff to protect the water quality of local lakes, wetlands, streams, and the Mississippi River.
- Increase green space and expand safe spaces for pedestrians and bicyclists.
- Extend the useful life of major capital street and sewer projects.
- Provide food and habitat for flora and fauna

GSI DESIGN CRITERIA

Stormwater runoff enters a GSI facility either through constructed features such as a curb cut or roadway catch basin, or by flowing directly onto the facility from adjacent surfaces such as streets, sidewalks, parking lots, or planted areas. The water that enters the facility will either infiltrate into the ground, be absorbed by vegetation, or be filtered by soil or other media before it is directed to the storm sewer system.

Each GSI facility should be designed per local stormwater management requirements, which include:

- [Minneapolis Ordinance Chapter 54 – Storm Water Management](#)
- [Minnesota Pollution Control Agency \(MPCA\) National Pollutant Discharge Elimination System \(NPDES\) Construction Stormwater Permit – MNR100001](#)

Local Watershed Requirements

- [Minnehaha Creek Watershed District](#)
- [Mississippi Watershed Management Organization](#)
- [Shingle Creek Watershed Management Commission](#)
- [Bassett Creek Watershed Management Commission](#)

GSI designs should generally comply with recommendations set forth in the following documents:

- [Minnesota Stormwater Manual](#)
- [National Association of City Transportation Officials \(NACTO\) Urban Street Stormwater Guide](#)
- [City of Minneapolis Standard Specifications and Detail Plates](#)
- [City of Minneapolis Stormwater and Sanitary Guide](#) or subsequent guidance and recommendations published by the Surface Water and Sewers Division for GSI and or drainage system work in the right of way

Figure 3.3E.1 summarizes the primary design criteria for GSI installations with applicable reference documentation and other notes. As the designer reviews the proposed project for potential GSI facilities, the drainage, hydrology, volume requirements, and setbacks of existing and proposed features will establish potential installation areas and types to meet performance requirements.

Figure 3.3E.1:

GSI Design Reference Criteria

Criteria	Reference	Notes
Contributing Drainage Area	Minnesota Stormwater Manual	Maximum drainage areas for type of GSI facility.
Site Suitability	City of Minneapolis Stormwater and Sanitary Guide	Identify concerns such as steep slopes (>10%), hot spots, water quality needs or total maximum daily loads (TMDLs), prior to siting infiltrating GSI
Hydrologic Parameters	City of Minneapolis Stormwater and Sanitary Guide	Parameter guidance (infiltration rates, runoff coefficients, methodology) and recommended modeling software

Criteria	Reference	Notes
Design Rainfall	City of Minneapolis Stormwater and Sanitary Guide or Local Watershed District Permitting Requirement, whichever is stricter	24-hour storm depths for standard return periods
Soils and Infiltration	Minnesota Stormwater Manual and MPCA NPDES Permit	Acceptable infiltration rate ranges for GSI and recommendations for secondary measures (see underdrains)
Underdrains	Minnesota Stormwater Manual	Minimum pipe diameter, cleanouts, materials, spacing, and slopes
Stormwater Volume	Minnesota Stormwater Manual	Water quality volume, channel protection volume, overbank flood protection volume, extreme flood control volume
Pretreatment	Minnesota Stormwater Manual	Minimum sizing based on infiltration rate and GSI ability to treat percentage of the water quality volume
Treatment	Minnesota Stormwater Manual	GSI facilities should be designed such that standing water drains or infiltrates through the system within 48 hours
Horizontal Setbacks	Minnesota Stormwater Manual	Setbacks from water supply wells, buildings, property lines, streams, septic systems, slopes, and karsts
Vertical Separation	Minnesota Stormwater Manual and MPCA NPDES Permit	Greater than 3 feet from bottom of infiltration media to saturated soil or bedrock. Karst areas require special design.
Utility Separation	Minnesota Stormwater Manual	Varies by case. The distance is generally 2 feet but needs to be reviewed with the utility type/owner and surrounding soil conditions. Some utilities such as telephone or water lines can be located within the facility. Others may require surrounding treatment or relocation to support or separate. Sanitary sewers or other utilities that could contaminate stormwater (or may be subject to infiltration and inflow risk) will need to be separate from GSI infiltration media.

GENERAL DESIGN CONSIDERATIONS

This section presents considerations to evaluate, select, and design GSI facilities. General GSI considerations are provided in the first part of this section and are followed by more detailed considerations for bioretention and permeable pavement facilities. Additional guidance and information can be found in the Minnesota Stormwater Manual and the National Association of City Transportation Officials Urban Street Stormwater Guide.

A.	Maximize pervious surfaces as much as feasible
B.	Delineate and estimate the drainage areas impacted by and flowing into a street design project and consider multiple GSI tools or facilities to cumulatively manage stormwater runoff.
C.	3' or wider buffers between the bike lane and traffic lanes are preferred. 2' buffers can be used for very space-constrained environments provided the location is not adjacent to a parking lane and the bike lane and buffer area generally maintain a minimum combined width of 8' (including the gutter).
D.	Design the GSI facility to provide water quality treatment for the required water quality volume. For each inflow point, define: <ol style="list-style-type: none"> 1. Total drainage area including impervious portion; 2. Right of Way (ROW) drainage including impervious portion; 3. Change in impervious area with street design project; and 4. Required and provided water quality volume for treatment.
E.	Consider soil amendments or an underdrain when the underlying soils' infiltration rate is outside of the range presented in the City of Minneapolis Stormwater and Sanitary Sewer Guide.
F.	<ol style="list-style-type: none"> 1. Provide access to maintenance areas such as any pre-treatment areas, inlets, underdrains, outlets or overflow devices, and vegetation. 2. Develop an Operations and Maintenance plan during design.
G.	Consider the best practices when selecting and siting GSI throughout stages of planning and design so that GSI can provide multiple benefits. For example, bioretention should generally be favored over permeable pavement due to the additional benefits of increased green space and reduced hardcover.
H.	Coordinate with Surface Water and Sewers Design and Planning Group to identify flooding within and near the corridor and to determine if flood mitigation features can be incorporated into the project.
I.	Submit stormwater management plans with 30%, 60%, 90%, and 100% plans (see Documentation section).

BIORETENTION

Bioretention includes small or mid-sized rain gardens, bioswales, tree trenches, and larger bioretention basins. These facilities are depressed, vegetated areas that capture, infiltrate or filter, and treat stormwater runoff. Bioretention may be installed as a vegetated, sloped facility such as a rain garden or bioswale or a vertical walled facility such as a planter or tree trench. Within street and roadway design, they are typically located within a median, along a boulevard, or in curb bump-outs. Engineered media can be used to amend the soils in the practice and promote infiltration.

Bioretention cells with sloped sides are preferred in locations with a larger available footprint for installation. Bioretention cells with vertical walls are more suitable for more urbanized locations, or locations with limited available footprint. The cell can be designed to infiltrate water into underlying permeable soils or can be filtered through soil or other engineered media and collected by an underdrain system when infiltration is not possible. Plantings provided in the facility enhance water quality by soaking up additional water and pollutants, and can range from grasses, flowers, and pollinators to shrubs and trees.

3.3E Green Stormwater Infrastructure

Figure 3.3E.2:
Sloped Surface Bioswale

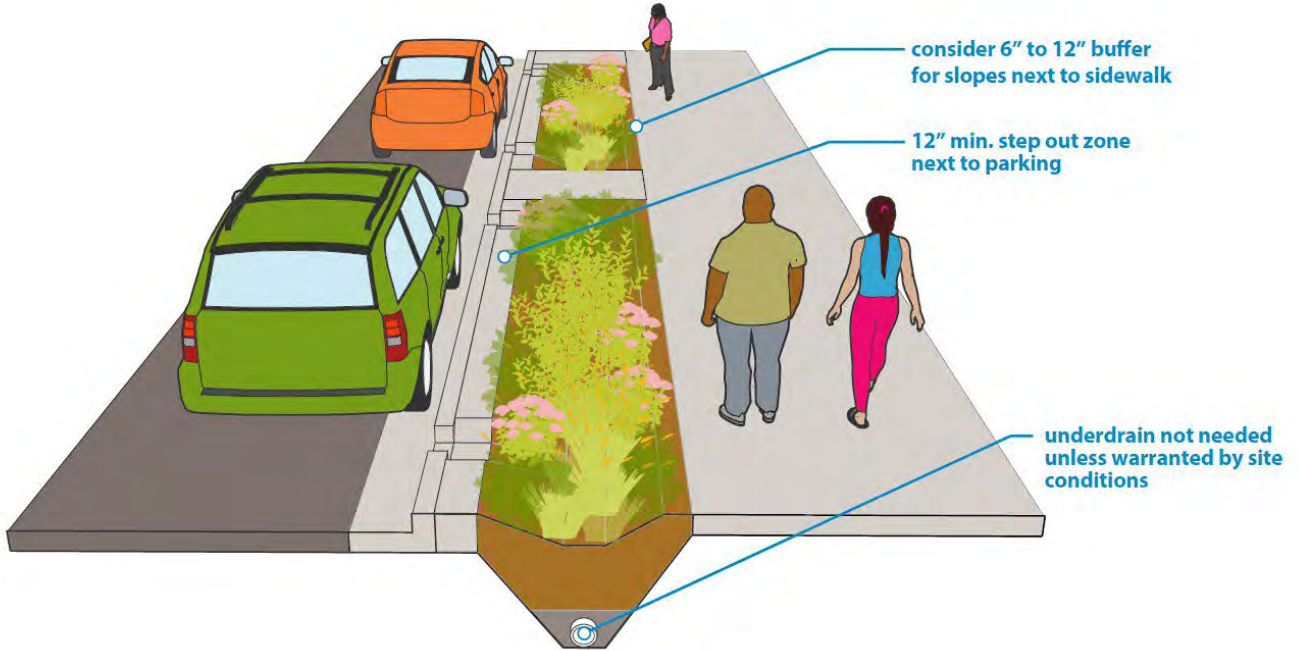
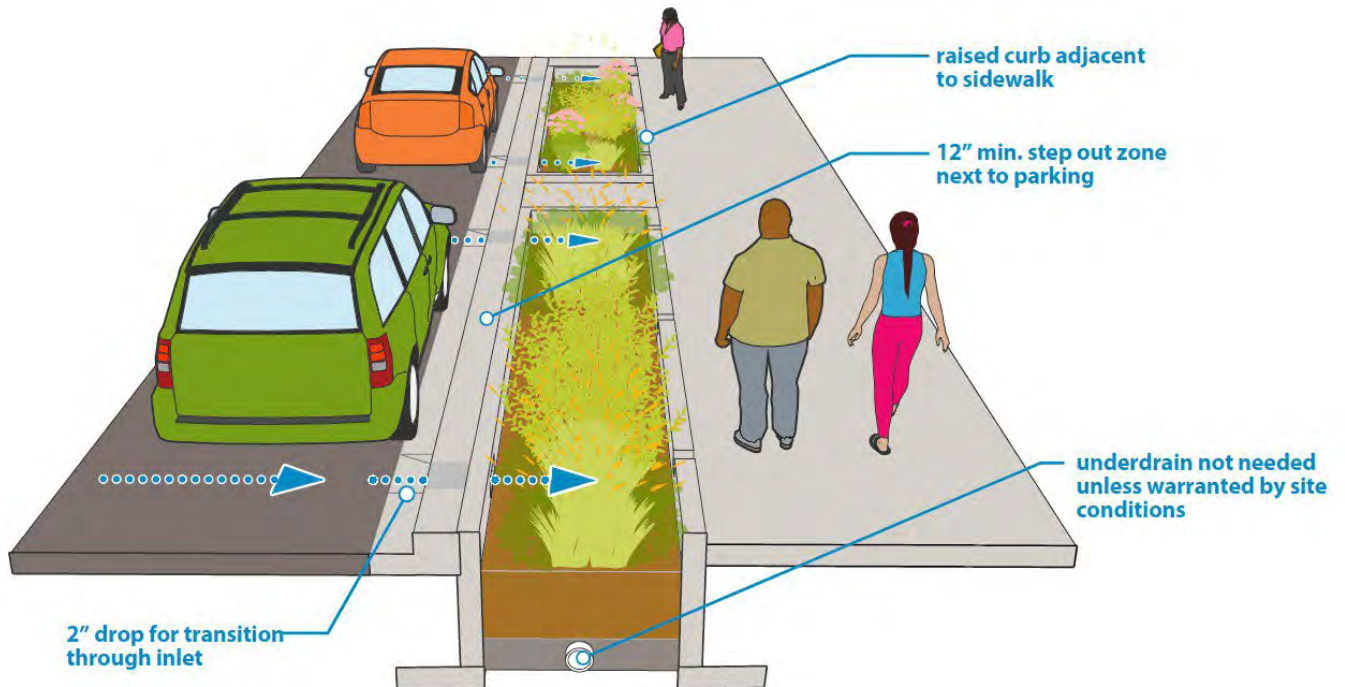

Figure 3.3E.3:
Vertical Wall Planter Bioswale



Bioswales are linear, sloped, vegetated areas designed to capture, treat, and convey stormwater runoff. Check dams can be used within the swales to reduce slopes, thereby encouraging detention, infiltration, and reducing flow velocities within the swale. Bioswales are a very flexible GSI facility that can be used in a variety of street improvement scenarios. Their linear shape can parallel road sections, follow medians, roadway swale/ditch segments, and linear green spaces adjacent to the curb and/or sidewalk.

A tree trench is a bioretention facility that includes a tree planted within engineered soil that is designed to store stormwater runoff and allow water to flow through the system and irrigate the tree. The media is a mixture of planting substrate and open graded aggregate that provides space to store runoff and for roots to grow. A tree trench can consist of one tree or can be a connected set of trees along a roadway. The system is designed to simultaneously treat stormwater runoff and promote healthy trees.

Bioretention design considerations

The following detailed design considerations should be considered when siting, selecting and designing bioretention GSI facilities:

FOOTPRINT:

- Design the engineered media mix thickness based on the site requirements. If the system design does not include infiltration, the media thickness should be between 2-6 feet (a minimum of 3 feet is recommended for plant health); see additional guidance on types of media mixes in [Minnesota Stormwater Manual](#). Use of an underdrain may impact the media mix thickness.
- Impermeable liners and / or underdrains should be used in locations where infiltration is not recommended or possible due to site limitations.
- If the site has a limited footprint, structural cells or subgrade storage can occur beneath the pavement surface. Review the minimum soil volume requirement for plant health (volume based on plant selection).
 - » Structural cells should be used where risk of underground disturbance is minimal.
- Provide sufficient space for treatment of stormwater according to soil infiltration capacity.
- Pretreatment features should be included at the upstream end of the facility to improve pollutant and debris removal, to assist with long-term maintenance by protecting the function and stability of the treatment facility, and to prolong the life of the bioretention facility. Pre-treatment should be designed for the drainage area conditions and GSI facility.

CURB CUTS:

- Curb cuts directing runoff into a GSI facility should be lower than the gutter elevation to limit runoff bypassing the facility. This reduces blockages at the inlet and allows a shovel to be used to remove debris.
- Curb cuts directing runoff directly into a GSI facility should provide energy dissipation at the inlet.
- Curb cuts directing overflows out of a GSI facility should be located upstream of a catch basin to provide nearby connection to the sewer system. A downstream catch basin will allow overflow to enter the sewer system during a storm event that surpasses the GSI facility's capacity.
- A standard curb cut transition to forebay/pretreatment area provides a minimum 2-inch drop from the gutter to the top of the bay.
- Consider the uses of the curb space. Avoid sites near or adjacent to vehicle unloading/loading zones. A maximum continuous length of GSI adjacent to parking is 30 feet, at which point a

minimum 5-foot-wide walkover should be provided. GSI facilities set adjacent to on-street parking should provide a level, 12-24-inch-wide step-out zone, depending on local parking conditions, along the curb to accommodate passenger entry and exit, and to reduce soil compaction and trampling.

- Bypass or overflow from larger storms can be achieved through: curb opening, grate structure, or inlet control.
 - » Preferred ponding depth is 6-18 inches. Greater ponding depths may be acceptable where pedestrian access is limited.
 - » Provide at least 2 inches of freeboard above the overflow elevation. Identify overflow location and shallowest freeboard on plans.
 - » The overflow opening may also act as inlet if there is sufficient stormwater flowing to it. Review the need for pretreatment or stabilization for potential inflow through the overflow opening.
- If using catch basins to convey runoff to GSI facility, use standard catch basin design.

INFILTRATION:

- Infiltration is key for minimizing ponding (depth and duration) on the surface of the GSI facility. Where vertical space separations can be achieved and additional subsurface area exists, consider installing deeper gravel or stone bed layers or proprietary subsurface chamber systems for increased storage and infiltration.
- The depth and porosity of the gravel or stone bed below the engineered media is key for storing water and allowing water to slowly infiltrate into subsurface soils based on a measured or calculated rate of infiltration; consider a bypass or “chimney” of gravel or stone to convey water to gravel or stone bed more efficiently in installations that do not have underdrains.
- Low infiltration rates can be enhanced with engineered media to replace existing soils and/or vertical slots of gravel stone to create increased hydraulic connection to more permeable existing soils.
- If the underlying native soils do not meet minimum infiltration standards, an undrain can be used to provide additional drainage to meet drawdown requirements.

DIMENSIONS:

- A minimum width of 4 feet is required for a GSI facility.
- If vertical walls have greater than a 6-inch drop, use a vertical indicator, such as raised curbs. Railings or fencing can be used.
 - » Vertical indicators should allow for runoff to enter the bioretention area.
 - Fence should be 18” to 36” in height and have no sharp edges.
 - The fence must be open on street side (3-sided design).
- Provide 6 to 12-inch shoulder next to sidewalks that don’t have vertical separation.
 - » If no shoulder is provided, the slope and sidewalk should be constructed to prevent undermining of the sidewalk.
 - » The shoulder should drop 1-2” and slope towards the ponding area at a slope of less than 5%
- Max slope is 3h:1v, unless next to existing tree, where max slope is 2h:1v.
- Install check dams the entire width of the bioswale, immediately following the swale stabilization.
 - » Provide at least 2 inches of freeboard above the design overflow and ponding depths.
- The longitudinal slope of the bioswale should not exceed 10%, the side slopes should be at a maximum 3h:1v and the bottom width should be at least 1-foot wide. Velocity should not exceed 4 fps (10-year, 24-hour storm). See [Minnesota Stormwater Manual](#).
- GSI facilities should consider needs for features such as light bases, signposts, carriage walks, and utilities including placement of conduits and mid-block hand holes.

PLANTS:

- Use native vegetation/pollinators that are wet and dry tolerant and salt tolerant, refer to [Minnesota Stormwater Manual](#)
- Surfacing should be vegetation where:
 1. Boulevard is 2' wide or wider (may be narrower where tapering)
 2. Median is 4' wide or wider, not including the curb space.

SOILS:

- See additional guidance on types of media mixes in [Minnesota Stormwater Manual](#).
- Stabilize soils and provide plant protection using biodegradable geotextile. Any mulch within ponding areas must be secured in place by fabric.
- Mulch should be shredded hardwood and not dyed (non-colored); it should not be placed directly on tree trunks or shrub/plant stems but rather around in ring formation.
- Avoid compacting underlying soils during construction. Scarify soils towards the end of construction if compaction could occur on site.
- Develop phasing plan to prevent over-compaction, prevent erosion, and allow for plants to establish.
- Soils installed in GSI facilities should be lightly compacted to prevent settling that changes the elevation of the GSI facility surface. Do not use compaction equipment.

PERMEABLE PAVEMENT

Permeable pavements are hard surfaces that allow water to flow through the surface and into a subbase of open graded rock. Pavements can consist of porous asphalt, pervious concrete, resin-bound aggregate, permeable interlocking concrete pavers, grass pave, flexible porous pavement, or alternative permeable surfaces. Beneath the pavement are layers of open graded rock that store water, remove pollutants, promote infiltration or retention of runoff. Permeable pavements can be used on the sidewalk, parking areas, driveways, roadways, and plaza spaces. This GSI type is best suited when space is limited, and they can serve as both a hard surface and a stormwater management practice. The base is designed to meet both the structural requirements of the pavement and any water volume and water quality goals.

Porous asphalt, pervious concrete, and other resin-bound aggregates should generally not be used in the right of way.

Permeable pavement spaces should not be sanded. Facilities should have small drainage areas and should be located where debris and sedimentation can be limited to prevent clogging of the openings. Ensure access to permeable pavement by sweeping equipment.

Figure 3.3E.4:

Permeable pavements

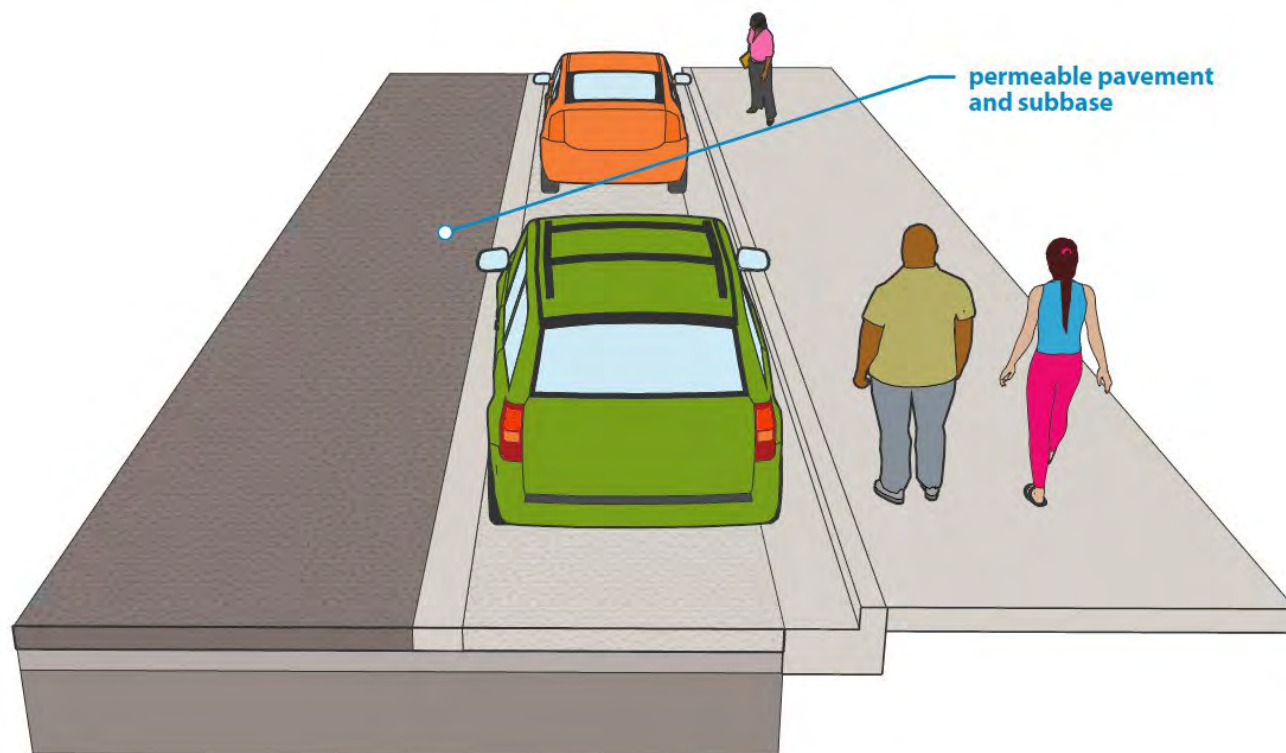

Permeable Pavement Design Considerations

In addition to the overall design considerations for GSI, permeable pavement can be designed for applicable street types where the following conditions occur:

- Avoid areas with frequent vehicle turning movements.
- Pavement uses:
 - » Low-volume, low-speed road
 - » Overflow parking or parking stalls
 - » Driveways or alleys
 - » Pedestrian areas
 - » Medians
 - » Furnishing zones
- Avoid road or pavement areas with frequent winter sanding.
- Avoid locations where spills may contaminate groundwater.
- Increased storage can be achieved beneath the system of pavers to increase infiltration capacity.
- Consider using permeable pavement up to the curb face to avoid water flowing down the gutter and bypassing the pavement.
- Review potential for sediment entrainment in the tributary storm water. Sediment deposition will increase the maintenance frequency.
- Ensure base course and bedding provide meet required pavement design.

DOCUMENTATION

Provide documentation as noted in the Stormwater Management Plan Content Requirements in the Minneapolis Stormwater and Sanitary Sewer Guide. The documentation can be presented as a technical memorandum or a stormwater management report, based on the project requirements.

Layout Approval and 30% Design

In addition to the pre-construction components noted in the guide:

- Layout/approximate location and type of GSI facilities
- Drainage Areas to each GSI facility
- Required (if applicable) and provided water quality volume for entire project and per each GSI feature
- General detail for GSI facility: cross-section, inlet, bypass
- Pedestrian safety considerations (both how pedestrians will detect potential drop-offs and how GSI facilities can be used to increase safety)
- Connections to stormwater conveyance system
- Identification of increased water quality needs (including TMDL)
- Identification of GSI considerations, such as steep slopes (>10%), hotspots, soil conditions, anticipated utility conflicts, adjacent existing uses to remain
- Vegetation changes (such as tree removal and additions)
- Coordination needs/opportunities (adjacent properties)
- Identify maintenance responsibilities and funding sources
- Coordinate with Surface Water and Sewers Division on key aspects of project including sewer and drainage system condition assessment, flooding within corridor, and GSI siting and details

60% Design

- Design calculations that incorporate survey and geotechnical information
- Include annual pollutant removal for TP and TSS (from MIDS or other approved WQ model)
- Refined layouts with design details
- Landscape plan
- Utility conflicts and mitigation approach (move, remove, protect)

90% Design

- Incorporate comments from reviewers and revisions based on coordination done at 60%
- Same content as 60%.
- Post Construction
- Delivery of As-built drawings of all infrastructure, contours, and soil modification.



The boulevard and furnishing zone includes a number of important above ground utilities and traffic control devices.

INTRODUCTION

The boulevard and furnishing zone includes a number of important above ground utilities and traffic control devices, including fire hydrants, traffic signals, streetlights, service cabinets, utility poles, waste receptacles, parking meter pay stations, signs, and bicycle racks.

See also guidance for: [street lighting](#), [bicycle and micromobility parking](#), and [transit stops](#).

Figure 3.3F.1:

Utilities and signs dimensions

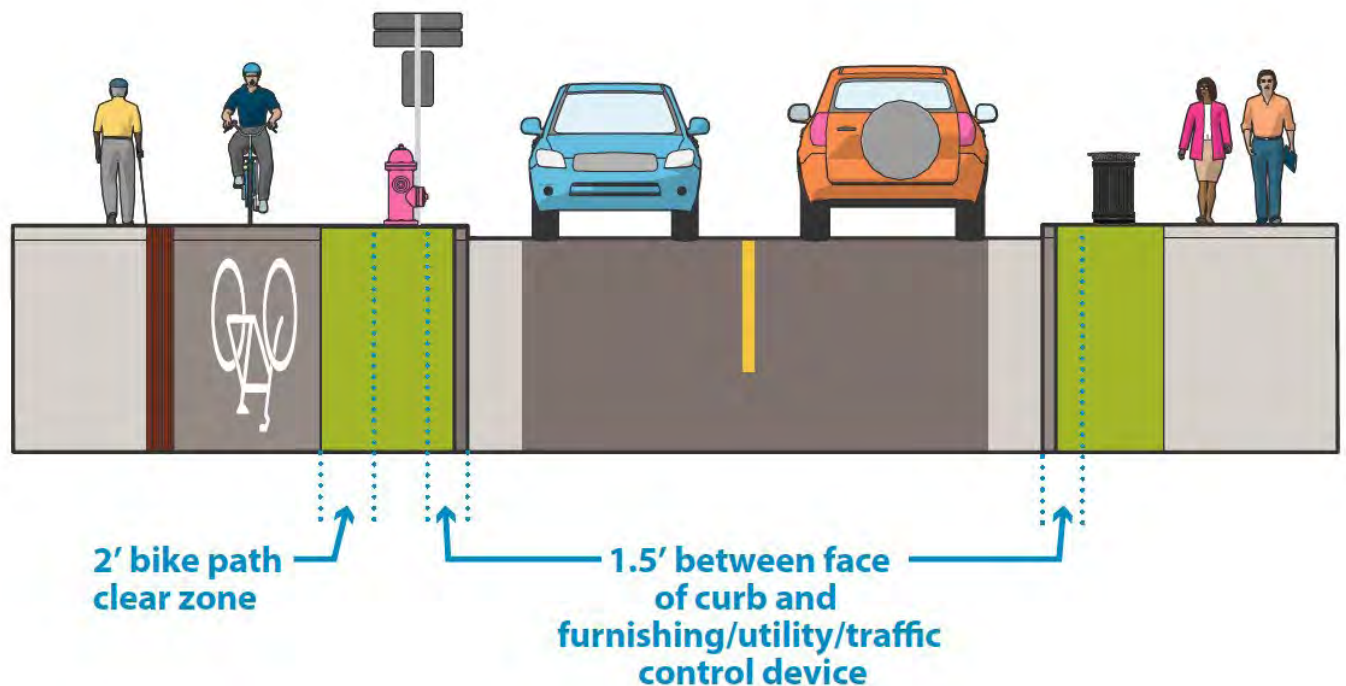

DESIGN CONSIDERATIONS

A. Clearance to curb	<p>1.5' clearance is generally required from the face of curb to utilities and signs, including for fire hydrants, service cabinets, APS pushbutton poles, utility poles, waste receptacles, parking meter pay stations, signs, and bicycle racks. 1' clearance is used between the face of curb and the edge of the foundation for streetlights. Traffic signals are typically centered 2' off the face of curb, which means the clearance is a minimum of 1' to the edge of the foundation.</p>
B. Location	<p>Utilities are often included in the corner public use zone (see elements of the sidewalk zone for more details).</p> <ol style="list-style-type: none"> 1. Traffic signals are located to try to accommodate an APS pushbutton without a separate pole while maintaining curb ramp and pedestrian clear zone access. 2. Service cabinets are typically placed down traffic from a signal pole to protect against collisions and generally need to be on the same side of the street through a corridor for interconnect.
C. Maintaining pedestrian and bicycle clear zones	<p>Other than accessible pedestrian signal push buttons, utilities and signs should not be located in the clear corner zone, the pedestrian clear zone, or the bicycle operating area. See sidewalk zone design guidance for recommended pedestrian clear zone widths by street type.</p>

The City of Minneapolis Street Lighting Policy provides a framework for how and where the City of Minneapolis will construct, operate, and maintain public street lighting.

INTRODUCTION

The [City of Minneapolis Street Lighting Policy](#) provides a framework for how and where the City of Minneapolis will construct, operate, and maintain public street lighting. The Street Lighting Policy has several key objectives:

- Maximizing the quality, sustainability, and visibility of the street lighting system.
- Contributing to added comfort and safety for pedestrians, bicyclist, transit users, and motorists.
- Creating a consistent and cohesive lighting system based in place-type characteristics throughout the City of Minneapolis.
- Providing pole and fixture options that are aesthetically pleasing and high quality.
- Providing clear guidance on expected installation methods, procedures and maintenance service levels.
- Creating a system that is cost-efficient, easy to operate, and maintainable.
- Addressing participation and implications for the capital, maintenance, and operational costs.

See the [Street Lighting Policy document](#) for additional details.

Figure 3.3G.1:

Streetlight design considerations

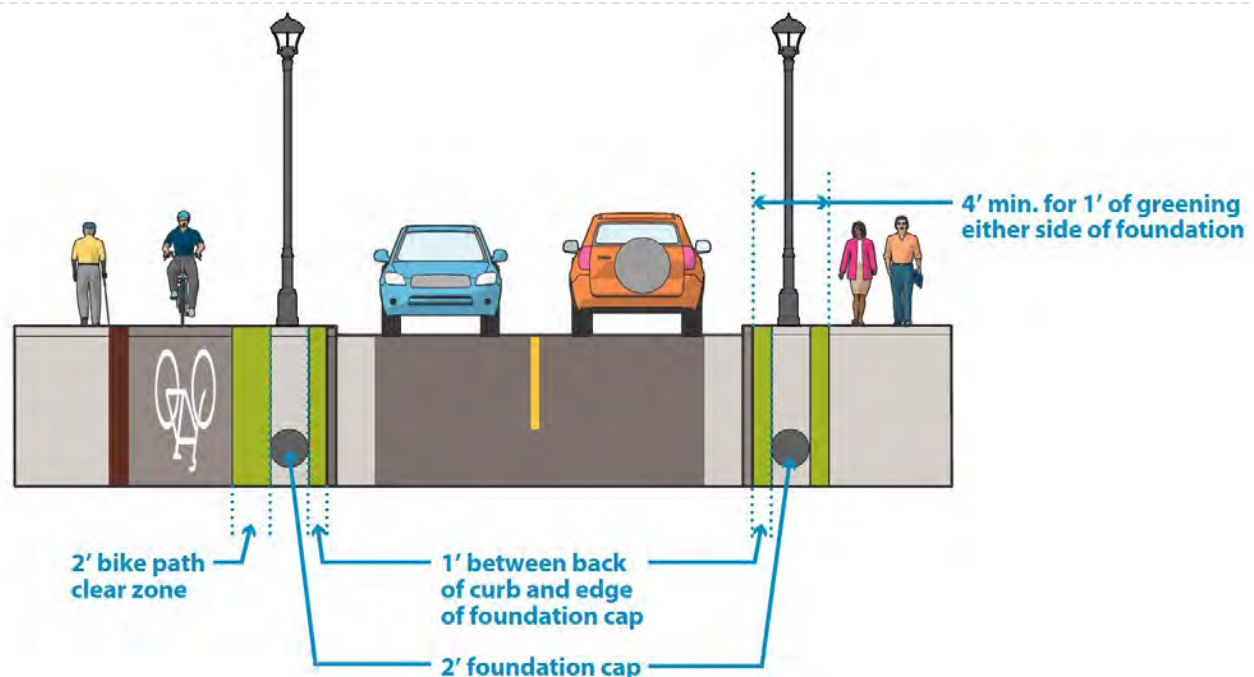

DESIGN CONSIDERATIONS

A. Pedestrian scale lighting	Pedestrian lighting should be used on all street reconstruction projects included as part of the capital project cost.
B. Spacing	Streetlight spacing will vary by designated street lighting areas. Please see the Street Lighting Policy document for additional details.
C. Size	Streetlights are 2' in diameter and require 1' of space between the back of curb and edge of the streetlight foundation. More details are in the standard plate.
D. Location	Streetlights should generally be located between the roadway and the sidewalk.
E. Bikeway clearance	When adjacent to a bikeway, there should generally be a minimum clearance of 2' between the streetlight foundation and the bikeway. In constrained environments or stop conditions, designers can consider narrower clearance.
F. Adjacent sidewalk width	When the streetlight is placed adjacent to the sidewalk, see sidewalk zone design guidance for recommended pedestrian clear zone widths by street type.
G. Adjacent planted boulevard	Streetlights should be surrounded with planted boulevard whenever possible. When the streetlight is placed in a planted boulevard, the boulevard should be at least 4' wide to provide at least 1' of space for plantings on either side of the streetlight foundation.

Different types of vehicles, including scooters, bikeshare, and other new vehicle types increase the need for safe spaces to park these vehicles.



INTRODUCTION

The proliferation of different types of vehicles, including scooters, bikeshare, and other new vehicle types increase the need for safe spaces to park these vehicles. The City currently operates five accommodations for bike and micromobility parking:

- **Bike rack program** – The Bike Rack Cost Share program allows eligible businesses to be reimbursed up to 50% of the bicycle rack cost and 50% of the installation cost. Schools, libraries, parks, and other eligible public facilities can request to receive racks at no cost. Contact the City for more details on bike rack and bicycle corral cost share programs.
- **Bike corral program** – The Bicycle Corral Cost Share Program is designed for businesses with high bicycle demand and limited space in the boulevard or sidewalk area. It is a low-cost method to provide bicycle parking in the same space occupied by an on-street parked car. Businesses are reimbursed for up to 50% of the bike corral cost.
- **Bike lockers** – Public bike lockers are available to rent at some locations including, Ramp A, Courthouse Ramp, the University of Minnesota, and at Metro Transit stations and transit centers.
- **Nice Ride station placement** – Nice Ride has both stations for docked bicycles and dockless pedal-assist ebikes. Their use of stations, docks, or racks may evolve in the future.
- **Scooter parking zones** – the City has created several temporary on-street scooter parking zones to provide a designated space for scooters to be parked, although generally scooters use bicycle parking spaces.

Bicycle and micromobility parking will be installed with all capital street projects; additional guidance will be added in the future. See Transportation Action Plan [Bicycle strategy 9](#) for more actions related to bicycle and micromobility parking.

DESIGN CONSIDERATIONS

A. Location

Bicycle and micromobility parking can be located in the boulevard and furnishing zone, the frontage zone, or as on-street corrals in the roadway zone.

1. Racks should not be placed in the clear corner zone (see [elements of the sidewalk zone](#) for more details), in the accessible boarding area of a transit stop, in a loading/unloading zone, or in a location that would block a fire escape.
2. Mounted bike racks should be placed on a flat, concrete surface not to exceed a 2% slope.

3.3H Bicycle and micro mobility parking

B. Maintaining pedestrian clear zones

A minimum 6' pedestrian clear zone must be retained adjacent to bicycle racks to ensure that a minimum ADA access is retained when bicycles are parked as parked bicycles may extend into the pedestrian clear zone. See [sidewalk zone design guidance](#) for recommended pedestrian clear zone widths by street type.

C. Clearances

Minimum distance between bicycle rack (not a bicycle parked at the rack) and existing element:

1. Edge of a door: 2'
2. Utilities: 2'
3. Fire hydrants: 10'
4. Face of curb: 1.5'
5. Street furnishings that require access (e.g benches): 5'

D. Spacing

Recommended spacing between racks is 3'-4' if adjacent to each other.

See [Minneapolis Bike Parking Options and Regulations](#) for additional details for bicycle racks.

E. On-street bicycle corrals

An on-street bicycle parking corral is a group of bicycle racks installed adjacent to the curb in the parking lane of a roadway. View detailed information for [on-street bicycle parking corrals](#).



3.31 Driveways

A driveway provides motor vehicle access from the roadway to adjacent private property.

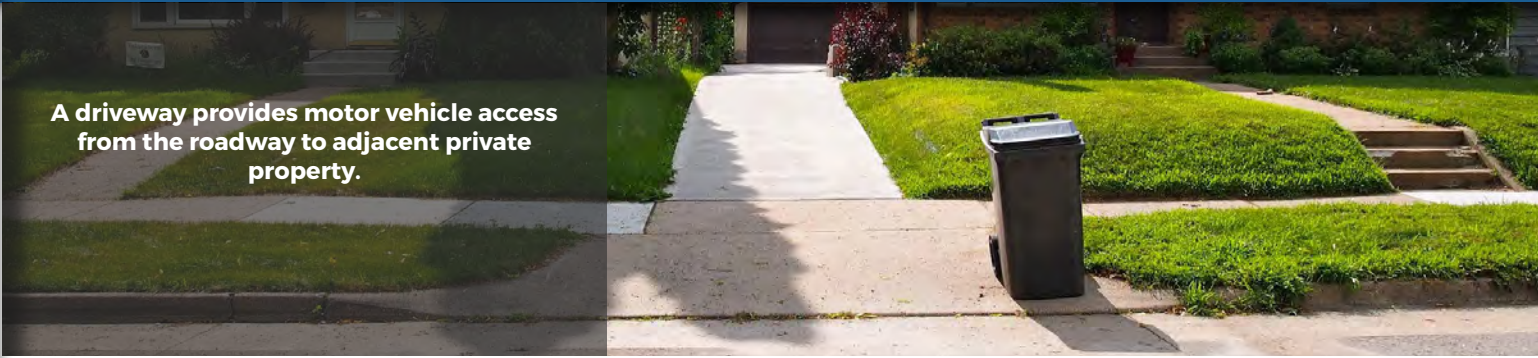

INTRODUCTION

A driveway provides motor vehicle access from the roadway to adjacent private property. Driveways typically run through the sidewalk and bikeway zones and should be designed to mitigate impacts to pedestrians and bicyclists. Driveways are regulated by [Chapter 541 of the Zoning Code](#); this regulation will be updated in 2021 to align with the Minneapolis 2040 plan.

Minneapolis 2040 includes these policies related to driveways:

Policy 5, action step q: Prohibit driveways for new small scale residential buildings on blocks that have alley access.

Policy 6, action step v: Limit, consolidate, and narrow driveways along pedestrian routes. In addition, discourage driveway access on Goods and Services Corridors.

Policy 18, action step d: Minimize the number of vehicle curb cuts that hinder pedestrian safety; be deliberate in the placement of drop-off zones and other curb side uses and evaluate the pedestrian benefits as a part of the decision-making process.

Policy 19, action step e: Minimize the number of vehicle curb cuts that hinder bicyclist safety; be deliberate in the placement of drop-off zones and other curb side uses, and evaluate the bicycling benefits as a part of the decision-making process.

Figure 3.31.1:
Driveways

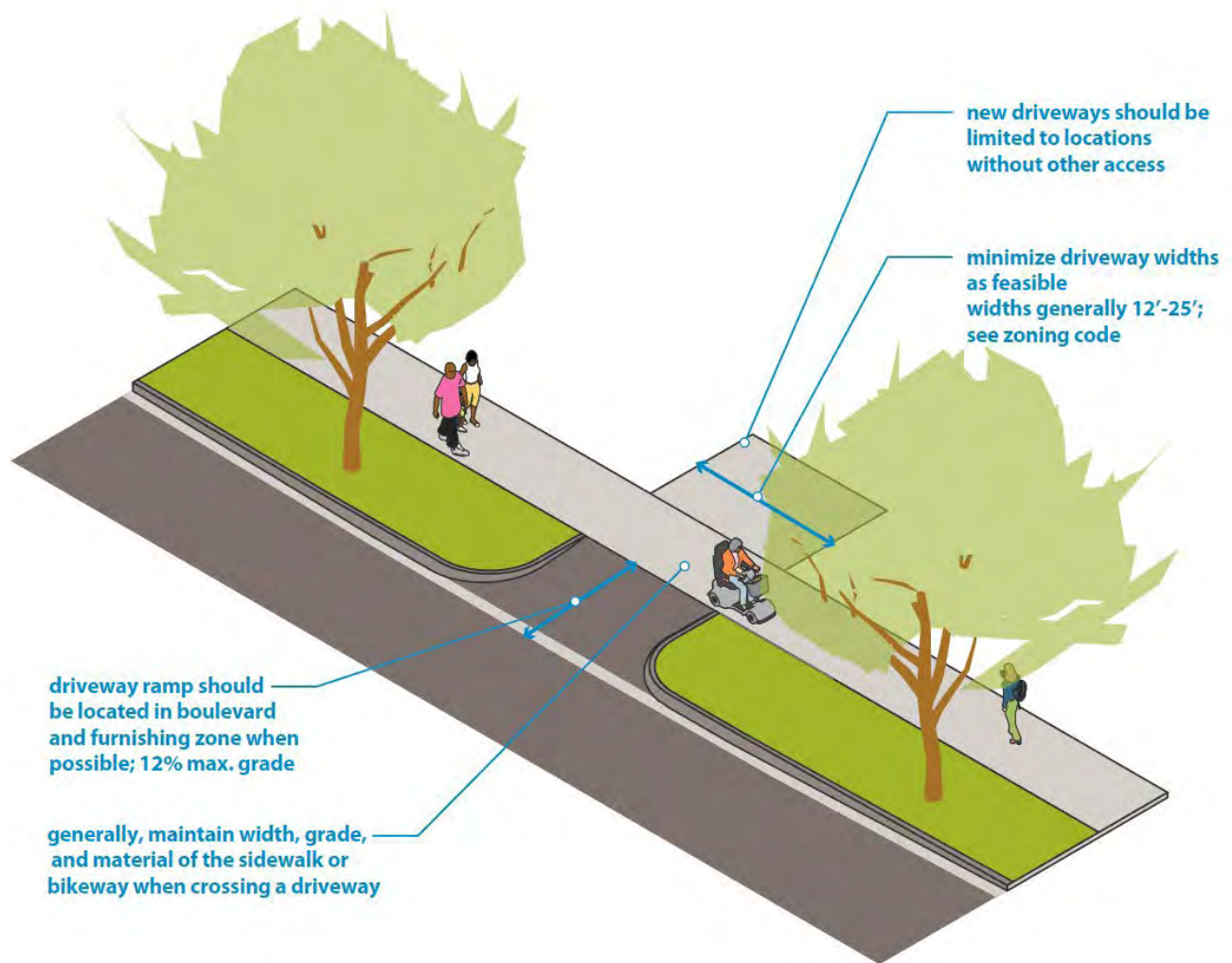

DESIGN CONSIDERATIONS

A. New driveways

New driveways should be limited to locations without alley or cross street access. Site plan review is required for any new driveway that impacts the sidewalk.

B. Consolidating, removing, and right sizing

1. In a street reconstruction project or site plan review process, designers should explore removing driveways that are no longer being used, are no longer permitted or compliant, are in excess of the site access/parking needs, or where access is provided via an alley. Designers should consider a wide variety of implications when removing driveways.
2. Designers should also explore right-sizing driveway curb cuts. This might result in some driveways being narrowed to improve safety. In some cases, driveways might need to be widened, such as to accommodate turning of existing vehicle sizes while narrowing the street.
3. This process includes collecting traffic data to determine vehicle mix, working with property owners to identify specific vehicles, confirming access points, time of day deliveries, and creatively maintaining suitable access.

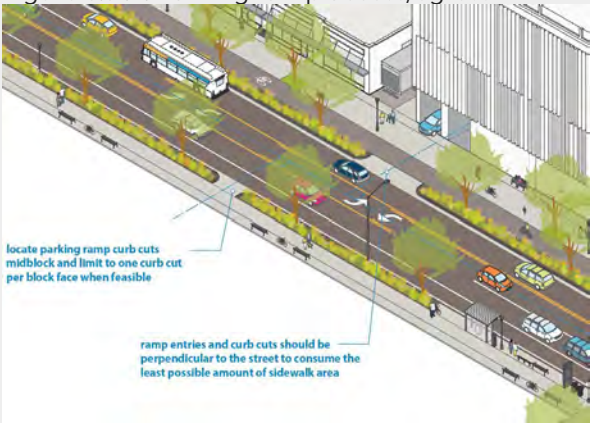
C. Driveway location	Driveways should be a minimum of 30' clear of the intersection of two major streets and a minimum of 20' from all other intersections to minimize conflicts.
D. Driveway width	Driveway widths should be minimized as feasible to reduce entrance speeds, maximize greening opportunities, and reduce pedestrian exposure at vehicle access points. Driveways widths are regulated by Chapter 541, Off Street Parking and Loading in the zoning code and vary by zoning district.
E. Sidewalk and bikeway interactions	<ol style="list-style-type: none"> 1. Driveways should minimize impacts to sidewalks, shared use paths, and bikeways to maintain consistent and comfortable user experience for people walking and biking. 2. The width and grade of the pedestrian clear zone or bikeway should generally continue across driveways whenever possible. In rare very constrained conditions, the pedestrian clear zone width may be reduced to 4' by driveways, and the sidewalk may be jogged away from the roadway to accommodate proper cross slope. 3. Where possible, the material of the sidewalk, shared use path, or bikeway should be continued across driveways to eliminate the need for horizontal expansion joints and provide additional visual delineation between the path and driveway surface.
F. Driveway ramp	The ramp portion of a driveway entrance should be located within the boulevard and furnishing zone wherever possible. The grade of driveway entrances in the boulevard and furnishing zone may not exceed a 12% grade.
G. Parking ramp and vehicular building access/egress	<p>Access to and egress from parking ramps should be designed perpendicular to the street in a single curb cut, as shown in Figure 3.31.2. This design promotes good visibility between pedestrians and vehicles and minimizes potential conflict points between pedestrians and vehicles. In large developments, it is recommended that vehicular curb cuts be located midblock and be limited to one curb cut per block face.</p> <p>Figure 3.31.2: Parking ramp access/egress</p> 

A sidewalk café is when a private business is permitted to place tables and seating in the public sidewalk zone.



INTRODUCTION

A sidewalk café is when a private business is permitted to place tables and seating in the public sidewalk zone. Designers may need to consider sidewalk cafes as they design the street. It is one example of how the City supports and regulates use of public right of way for commercial use. Work closely with Regulatory Services for the successful planning, design, and implementation of zones used for retail or other similar uses. The [license application for sidewalk cafes](#) includes the permit requirements. Sidewalk cafes can substantially improve the walking environment; however, it is necessary to balance their placement with the need to maintain the pedestrian clear zone.

DESIGN CONSIDERATIONS

The City's [Sidewalk Café regulations](#) including the following requirements that may impact street design decisions:

A. Clear zones

1. For sidewalks 12' or narrower: a minimum of 4' of clear, unobstructed pedestrian clear zone must be maintained between all obstructions and the edge of sidewalk cafés. The pedestrian clear zone must widen to 6' for a minimum of 6' every 30' to provide ample room for two or more wheelchairs, strollers, or pedestrians to pass. When two neighboring cafes fall within the 30' zone, both will equally share the 6' zone.
2. For sidewalks wider than 12': A minimum of 6' of clear, unobstructed pedestrian clear zone must be maintained between all obstructions and the edge of sidewalk cafés. Tables and heating elements must be aligned as straight as possible.
3. For cafes adjacent to the roadway on streets without on-street parking, a 2' clear zone from back of curb must be maintained at all times when tables and chairs are occupied.

Unless specifically exempted, cafes must be in a physically delineated area, either marked by structural devices such as planters or stanchions or with painted markings on the sidewalk.

B. Parking and loading zones

Delineator-protected bike lanes directly adjacent to the curb should generally include a minimum of 4 feet of smooth, rideable surface, excluding any adjacent gutter pan. In very constrained right of way where every consideration has been taken to narrow roadway street zones, 3.5' of smooth, rideable surface can be used for short stretches.

C. Location restrictions

1. Sidewalk cafes are not permitted curbside if parking meters or active loading zones are present anywhere on the block face.
2. Sidewalk cafes typically may not be located within 10' of a designated bus stop, taxi stand, traffic signal, crosswalk, pedestrian curb cut, or active loading zone. Public Works can grant an exception in some situations.

In addition to these regulations, the following guidelines are recommended:

D. Pedestrian clear zones

1. The pedestrian clear zone widths in the [sidewalk zone design guidance](#) are wider than the existing sidewalk café regulations. These wider widths should be used when possible, particularly in activity centers and other locations with high pedestrian activity.
2. A straight and continuous pedestrian clear zone from one end of the block to the other should be maintained to the greatest extent possible.

E. Fences

Fences should be continuous, stable and rigid. A continuous edge should be provided no more than 6 inches from the ground, and an upper rail should be provided at a minimum of 3' above the ground. Support members should not protrude into the pedestrian clear zone.



The City's Transportation Action Plan establishes an All Ages and Abilities (AAA) Bicycle Network to make bicycling a real possibility for more people.

BIKEWAYS INTRODUCTION AND GENERAL GUIDANCE

The City's [Transportation Action Plan](#) establishes an [All Ages and Abilities \(AAA\) Bicycle Network](#) to make bicycling a real possibility for more people. The goal for the All Ages and Abilities Network is for people on bikes to only share space with cars on quiet low-speed streets or on neighborhood greenways. This network will include protected lanes and trails that are physically separated from moving cars, trucks and buses, will feature improved intersection crossings, and be accessible year-round.

The All Ages and Abilities Network will include three primary bikeway types:

Protected bike lanes:

routes on relatively busy streets with some form of physical separation from motor vehicle traffic, such as bollards, concrete curbs, parked cars, and planters.

Trails/Shared Use Paths:

non-motorized paths for pedestrians and bicyclists, typically more separated from the street than protected bike lanes, and are typically located near rivers, lakes, parkways, and railroad corridors.

Neighborhood greenways:

routes that enhance local, low volume streets and give priority to people walking, biking, and rolling. This will include removing or significantly limiting motor vehicles along sections of the street.

There is an additional type of bikeway highlighted on the All Ages and Abilities Network called connector bikeways. Connector bikeways are standard or advisory bike lanes without physical separation from motor vehicles that may or may not meet the definition of an All Ages and Abilities bikeway depending on the context of the street (including volume, width and speeds).

To implement a AAA bicycle network by 2030 and meaningfully expand bicycling as an option for more people, non-AAA bicycle facilities should generally only be installed during street retrofit projects such as mill and overlays or spot improvement projects. Please reference Figure 3.4A.1 when considering when and what bicycle facilities to implement with street retrofit and reconstruction projects:

Figure 3.4A.1:

Bike lane implementation matrix

Bikeway Type	Street Retrofit Project	Street Reconstruction Project	AAA Bike Facility Type?
Shared Use Path	✓	✓	✓ Yes
Sidewalk-Level Bike Lane	✓	✓	✓ Yes
Neighborhood Greenway: Full Greenway	✓	✓	✓ Yes
Neighborhood Greenway: Bicycle Boulevard	✓	✓	✓ Yes
In-Street Curb-Protected Bike Lane	✓	✗	✓* Yes, for retrofits only
Delineator-Protected Bike Lane	✓	✗	✓* Yes, for retrofits only
Planter-Protected Bike Lane	✓	✗	✓* Yes, for retrofits only
Buffered Bike Lane, Unprotected	✓	✗	✗ No
Bike Lane, Unprotected	✓	✗	✗ No
Advisory Bike Lane, Unprotected	✓	✗	✗ No

The bicycle facility design recommendations included in this design guide are informed and supplemented by the following plans and design manuals. Please reference these guides for additional details specific to bikeway facility design standards, implementation considerations, and best practices:

- [Minneapolis Transportation Action Plan \(“TAP”\)](#)
- [The Minnesota Department of Transportation Bicycle Facility Design Manual](#)
- [Minnesota Manual on Uniform Traffic Control Devices \(“MnMUTCD”\)](#)
- [NACTO Urban Bikeway Design Guide](#)
- [FHWA Separated Bike Lane Planning and Design Guide](#)
- [American Association of State Highway and Transportation Officials Guide for the Development of Bicycle Facilities \(“AASHTO Bike Guide”\)](#)

Exclusive facilities for biking and micromobility that incorporate separation from motorized traffic, parking lanes, and adjacent walking facilities.

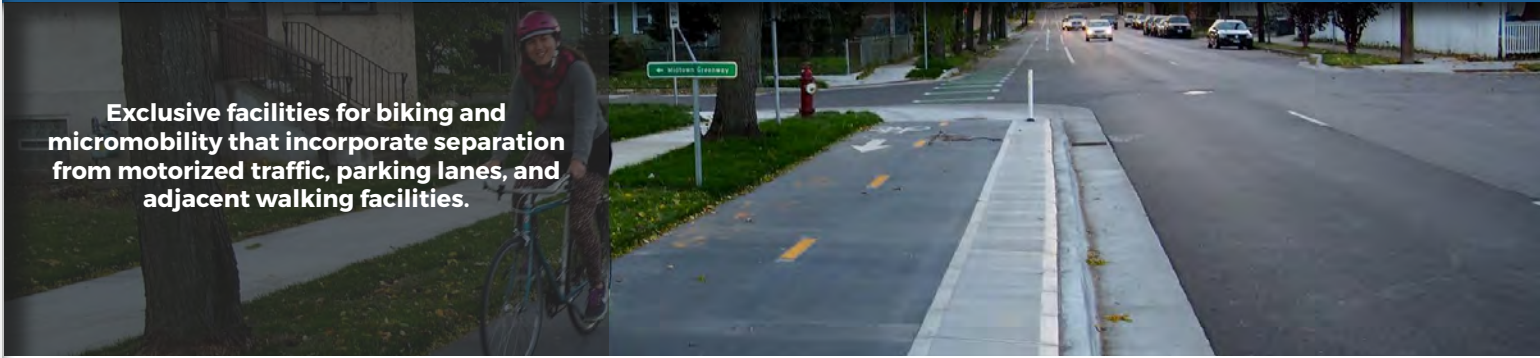

INTRODUCTION

Protected bike lanes are exclusive facilities for biking and micromobility that incorporate physical, vertical separation from motorized traffic, parking lanes, and adjacent walking facilities. The methods used to provide physical separation vary and include plastic flexible delineators or “bollards,” rail-mounted bollards, planters, in-street concrete curbs, and curb-protected sidewalk-level bike facilities. Parked cars can sometimes buffer protected bike lanes from motorized traffic but should be implemented along with other vertical delineation to eliminate encroachment into the bikeway. Protected bike lanes may operate as one or two-way facilities and may be designed to operate on one or both sides of a roadway.

By incorporating physical separation from motorized traffic and adjacent facilities, protected bike lanes provide enhanced safety and comfort for people of all ages and biking abilities. Protected bike lanes are All Ages and Abilities bikeways, and are the preferred treatment for any street reconstruction project on the AAA network where a trail, shared use path, or neighborhood greenway is unfeasible or not preferred.

ONE-WAY AND TWO-WAY PROTECTED BIKE LANES

Protected bike lanes may be designed for one-way or two-way operation. One-way protected bike lanes are typically preferred on streets with two-way traffic as they usually present fewer modal conflict points, require fewer intersection treatments, and better integrate with existing roadway operations. Contextual design factors may favor two-way operations in some contexts, for example, streets with few points where there would be left turns across the bikeway or streets where one-way protected bikeways are not feasible because of constrained right of way. Two-way bikeways have fewer conflicts on streets with one-way vehicle traffic. Please consider the criteria in Figure 3.4B.1 when deciding between one and two-way protected bikeways.

3.3J Sidewalk cafes

Figure 3.4B.1:

One-way and two-way bike lane considerations

		Protected Bikeway Type		
		One-way, one side of the street	One-way, two sides of the street	Two-Way, one side of the street
Street Configuration	 One-way Street	<ul style="list-style-type: none"> + More consistent with existing roadway operations and driver expectations + May require fewer modifications to signalized intersections - Does not accommodate two-way bicycle travel and may encourage contra-flow travel in bike lane 	<p>Not recommended. If there is space for bidirectional bike traffic install a two-way bikeway on one side of the street.</p>	<ul style="list-style-type: none"> + Provides two-way bicycle access + May improve bikeway network connectivity - Drivers may not expect contra-flow bicycle traffic - Only provides direct bicycle access to one side of the street - May require changes to signal heads, signal timing, and turn phasing
	 Two-Way Street	<p>Not recommended but a single contraflow lane may be installed in space-constrained corridors where there are few alternate routes that provide similarly convenient travel for people biking, and on streets where existing contra-flow riding is regularly observed.</p>	<ul style="list-style-type: none"> + More consistent with existing roadway operations and driver expectations + May require fewer modifications to signalized intersections + Provides direct bicycle access to both sides of the street - Requires more space than two-way bikeways on one side of the street - May be challenging to accommodate space requirements in constrained ROWs - May require more maintenance resources than two-way bike facilities on one side of the street 	<ul style="list-style-type: none"> + Provides two-way bicycle access + Often require less space than one-way bikeways in each direction - May require changes to signal heads, signal timing, and turn phasing - Only provides direct bicycle access to one side of the street - May require more complex transitions when connecting to one-way bicycle facilities

Delineator-protected bike lanes utilize plastic delineators or “bollards” and a buffer space to provide separation from motorized traffic.

INTRODUCTION

Delineator-protected bike lanes utilize plastic delineators or “bollards” and a buffer space between the bikeway and travel or parking lane to provide physical separation from motorized traffic. Delineator-protected bike lanes should only be used with street retrofit projects; use a more robust protected bike lane type with vertical protection with permanent materials for street reconstruction projects.



Figure 3.4C.1:

Delineator-protected bike lane dimensions table

Delineator-Protected Bike Lane	Bike Lane (widths include gutterpan)			Buffer		Delineator		
	Preferred Width (ft)	Constrained Minimum Width (ft)	Maximum Width (ft)	Minimum Width (ft)	Maximum Width (ft)	Minimum Spacing (ft)	Maximum Spacing (ft)	Minimum Lateral Clearance (ft)
One-Way	6-7	5.5 ^a	8	2 ^b	None	10 ^c	30'	1
Two-Way	12	8	14					

^a Constrained minimum widths should only be used for short stretches in constrained right-of-way where every consideration has been taken to narrow roadway street zones. Constrained minimum widths are inclusive of the gutterpan.

^b If buffer is adjacent to a parking lane, 3 or more feet is recommended.

^c < 10' delineator spacing may be used at intersection and conflict zone approaches where vehicular encroachment is anticipated.

3.4C Delineator-protected bike lanes

Figure 3.4C.2:

Delineator-protected bike lane dimensions graphic

1-Way Delineator Protected Bike Lanes

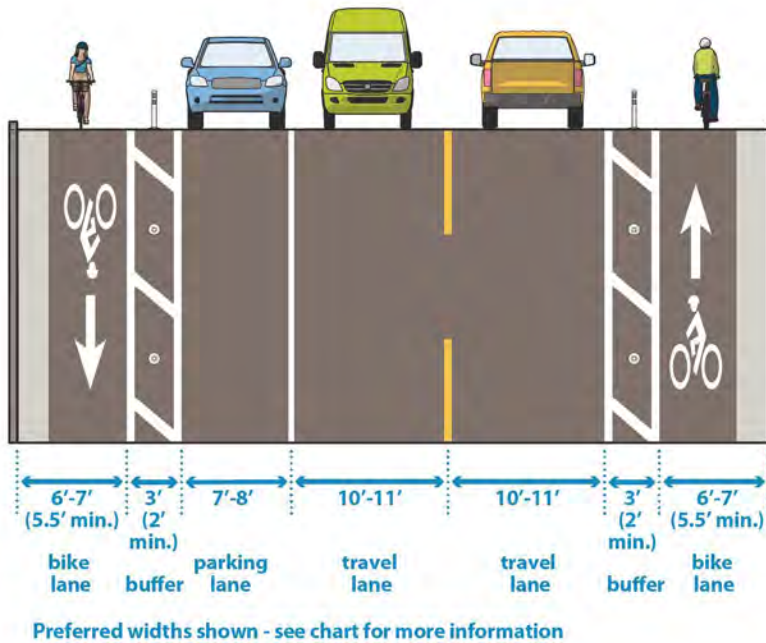

2-Way Delineator Protected Bike Lanes

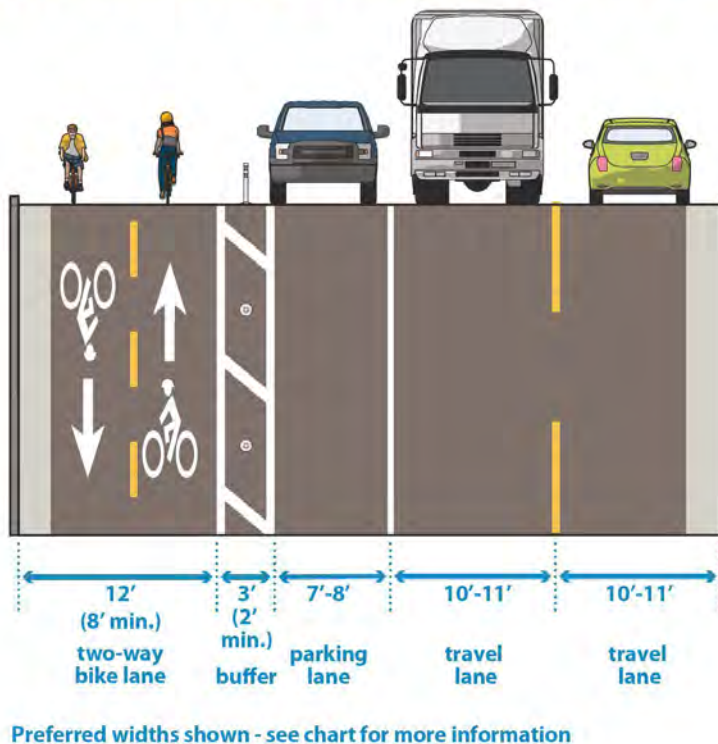

DESIGN CONSIDERATIONS

A. Operation	Delineator-protected bike lanes may be designed for one-way or two-way bicycle traffic.
B. Gutter pan considerations	Delineator-protected bike lanes directly adjacent to the curb should generally include a minimum of 4 feet of smooth, rideable surface, excluding any adjacent gutter pan. In very constrained right of way where every consideration has been taken to narrow roadway street zones, 3.5' of smooth, rideable surface can be used for short stretches.
C. Buffer width	3' or wider buffers between the bike lane and traffic lanes are preferred. 2' buffers can be used for very space-constrained environments provided the location is not adjacent to a parking lane and the bike lane and buffer area generally maintain a minimum combined width of 8' (including the gutter).
D. Combined dimensions with parking	<p>The total minimum combined dimensions of the bike lane, buffer, and parking lane for a one-way parking protected bikeway is:</p> <ol style="list-style-type: none"> 1. 16' along streets with lower traffic volumes and less parking demand, with 15' allowed for very short stretches. 2. 17' along busier streets to prevent parking encroachments in the bike lane.
E. Delineator spacing	Delineators should be centered in the buffer area and spaced at increments between 10' and 30,' with closer spacing where vehicular encroachment into the bike lane is anticipated.
F. Bike lane width	Wider bike lanes are preferred in environments with higher bicycle volumes to support passing.
G. Buffer width	Wider buffers are preferred on corridors with a high percentage of heavy vehicles, established loading zones, and where adjacent parking utilization and/or turnover is high.
H. Parking lane considerations	<ol style="list-style-type: none"> 1. When a parking lane is located on the same side of the street as a delineator-protected bike lane, the parking lanes should be located between the bike lane buffer and travel lane, sometimes referred to as "floating" parking. 2. To prevent doors from encroaching into the bike lane, the buffer between the bike lane and parking lane is recommended to be a minimum of 3' to prevent doors from opening into the bike lane operating area, although 2.5'-wide buffers can be considered in for short stretches in constrained right of way where every consideration has been taken to narrow roadway street zones.
I. ADA considerations	Designers should implement strategies to support ADA access to parking spots, bus stops, and Metro Mobility drop off points along protected bike lanes. Additional details will be forthcoming in a future update to the Street Design Guide.
J. Intersection guidance	See also bikeway intersection design guidance .

3.4D Planter-protected bike lanes

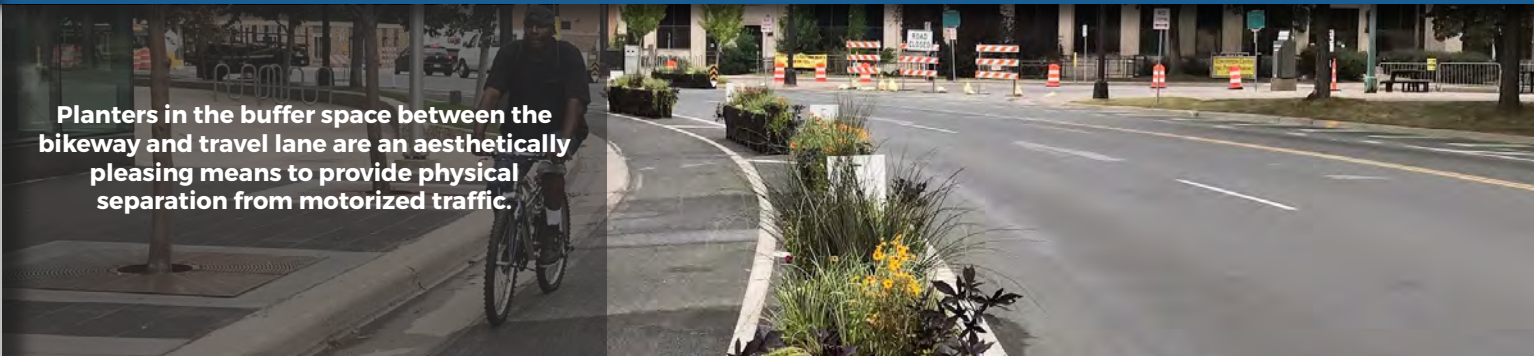

Planters in the buffer space between the bikeway and travel lane are an aesthetically pleasing means to provide physical separation from motorized traffic.

INTRODUCTION

Planters may also be implemented in the buffer space between the bikeway and travel lane as an aesthetically pleasing means to provide physical separation from motorized traffic. Planters are typically implemented as an upgrade to unprotected or delineator-protected bike lanes. The considerations in this section build on the guidance for delineator-protected bike lanes, which should serve as the starting point for any in-street curb-protected bikeway.



Planter-protected Bikeways on 3rd Ave

Figure 3.4D.1:

Planter-protected bike lane dimensions table

Planter-Protected Bike Lane Dimensions

Planter-Protected Bike Lane	Bike Lane (widths include gutterpan)			Buffer		Planter		
	Preferred Width (ft)	Constrained Minimum Width (ft)	Maximum Width (ft)	Minimum Width (ft)	Maximum Width (ft)	Minimum Spacing (ft)	Maximum Spacing (ft)	Minimum Lateral Clearance (ft)
One-Way	6-7	5.5 ^a	8	4	None	0 ^b	30	1
Two-Way	12	8	14					

^a Constrained minimum widths should only be used for short stretches in constrained right-of-way where every consideration has been taken to narrow roadway street zones. Constrained minimum widths are inclusive of the gutterpan.

^b Contiguous planter spacing may be utilized when not adjacent to parking.

3.4D Planter-protected bike lanes

Figure 3.4D.2:

Planter-protected bike lane dimensions graphic

1-Way Planter Protected Bike Lanes

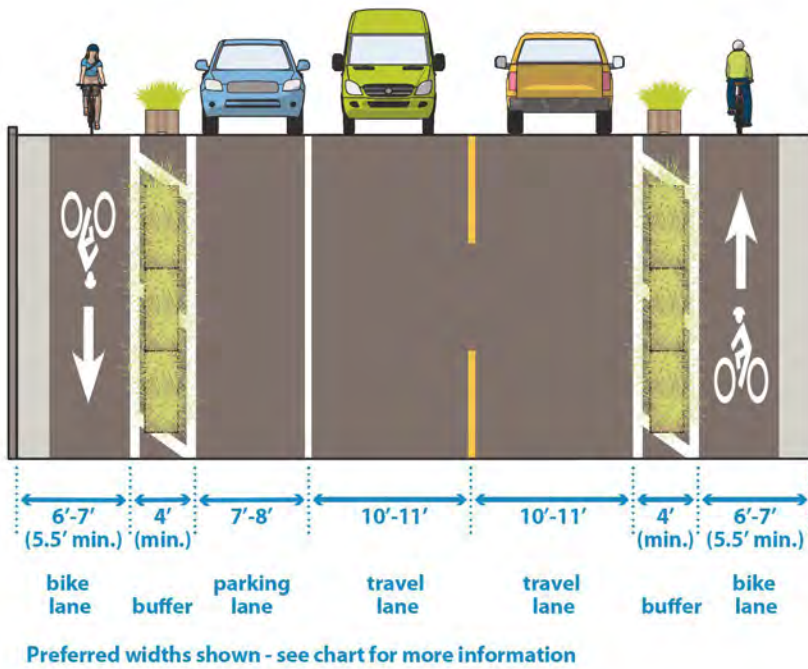

2-Way Planter Protected Bike Lanes

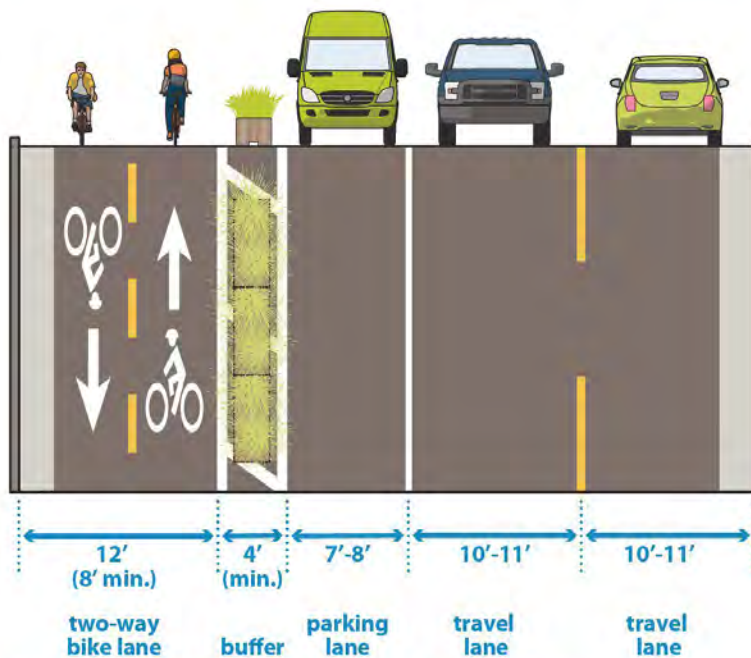

DESIGN CONSIDERATIONS

A. Operation	Planter-protected bike lanes may be designed for one-way or two-way bicycle traffic.
B. Gutter pan considerations	Delineator-protected bike lanes directly adjacent to the curb should generally include a minimum of 4 feet of smooth, rideable surface, excluding any adjacent gutter pan. In very constrained right of way where every consideration has been taken to narrow roadway street zones, 3.5' of smooth, rideable surface can be used for short stretches.
C. Planter spacing	Planters should be centered in the buffer area and spaced at 10' to 30' increments with closer spacing where vehicular encroachment into the bike lane is anticipated.
D. Signage	Type-3 object markers should be installed on or near the end of each planter oriented towards the adjacent travel lane to improve visibility.
E. Plastic delineators	Plastic delineators should augment planter-protected bikeways and should be installed in the center of the buffer area at regular increments in the gaps between planters.
F. Full street reconstructions	Permanent planters or planted boulevards should be used to physically separate the bikeway from motorized traffic during full street reconstructions.
G. Bike lane dimensions	Should include a minimum of 4 feet of smooth, rideable surface, excluding any adjacent gutter pan.
H. Buffer width	While planter width varies, a minimum buffer width of 4' should be assumed for adequate clearance, and a minimum of 1' clearance should be maintained from the planters to the adjacent travel lane and the bikeway operating space.
I. Planter dimensions	Planters may range in height from 22" to 36" (not including the plantings). To maintain adequate sightlines, planters should not be located within 30' of intersection approaches, or within 20' of approaching driveways, alleys, or any vehicular mixing/conflict zones.
J. Maintenance	<ol style="list-style-type: none"> 1. A plan for ongoing planter maintenance responsibilities should be identified and coordinated in advance of implementation. 2. Consider maintenance needs when determining buffer and bike lane widths to provide suitable access for watering, pruning, cleaning, and other routine maintenance and snow clearance/removal. 3. Should maintain a minimum width of 6' between the planter and curb to accommodate routine maintenance and snow clearance/removal.
K. Parking lane considerations	Parking lanes adjacent to planter-protected bikeways should be located between the bike lane buffer and travel lane, and a minimum bikeway buffer width of 4' should be assumed. To allow access across the bikeway from the parking lanes, 6' gaps in planter spacing should be assumed at the ends of each parking stall. In areas with high parking utilization, it may be helpful to stripe parking stalls to maximize parking efficiency.
L. ADA considerations	Designers should implement strategies to support ADA access to parking spots, bus stops, and Metro Mobility drop off points along protected bike lanes. Additional details will be forthcoming in a future update to the Street Design Guide.
M. Intersection guidance	See also bikeway intersection design guidance .

3.4E In-street curb-protected bike lanes

In-street concrete curb protected bike lanes utilize a form-in-place concrete curb installed on the roadway surface to provide physical separation from motorized traffic.

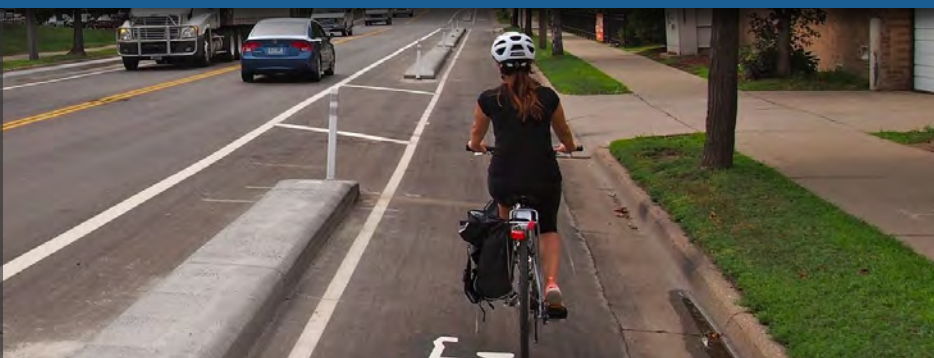

INTRODUCTION

In-street concrete curb protected bike lanes utilize a form-in-place concrete curb installed on the roadway surface to provide physical separation from motorized traffic. Form-in-place concrete curbs provide numerous advantages over bollard-delineated bikeways, including reduced annual maintenance costs and reduced vehicular encroachment into the bike lanes. They are typically implemented as an upgrade to non-protected or delineator-protected bike lanes. The considerations in this section build on the guidance for delineator-protected bike lanes, which should serve as the starting point for any in-street curb-protected bikeway.



In-Street Curb-Protected Bike Lanes on Oak Grove St

Figure 3.4E.1:

In-street curb-protected bike lane dimensions table

In-Street Curb-Protected Bike Lane	Bike Lane (widths include gutterpan)			Buffer		Form-in-Place Curb		
	Preferred Width (ft)	Minimum Width (ft)	Maximum Width (ft)	Minimum Width (ft)	Maximum Width (ft)	Minimum Spacing (ft)	Maximum Spacing (ft)	Minimum Lateral Clearance (ft)
One-Way	7-8	6	8	4 ^a	None	0 ^b	6 ^c	1
Two-Way	12	8	14					

^a Minimum buffer width assumes a 2' curb with 1' reactions on both sides of the curb.

^b Contiguous curbing should be utilized when not adjacent to parking with breaks for stormwater runoff and utility access covers where necessary depending on the characteristics on-site.

^c A maximum gap spacing of 6' should be utilized for mid-block curbing excepting breaks for driveways and alleys that may exceed 6'.

Figure 3.4E.2:

In-street curb-protected bike lane dimensions graphic

1-Way In-Street Curb-Protected Bike Lanes

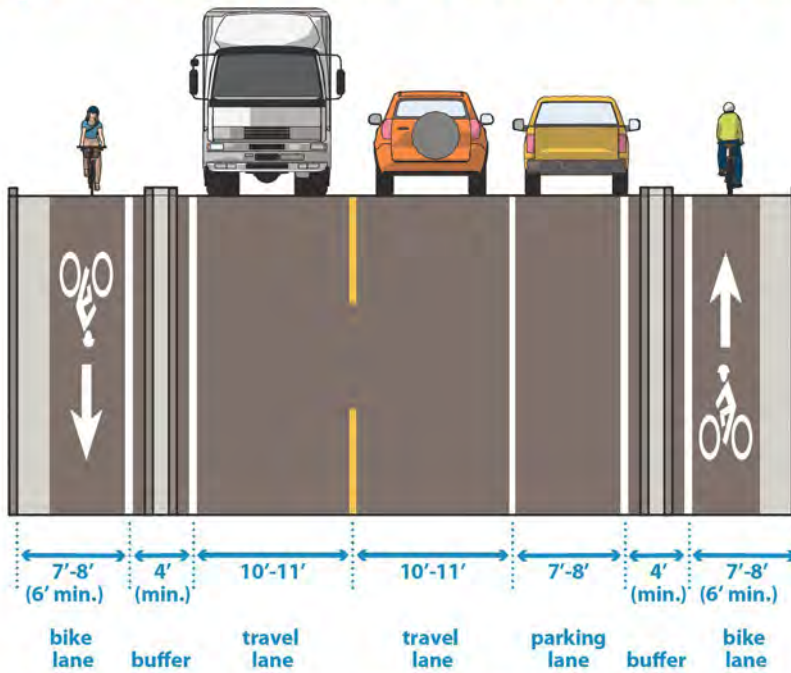

Preferred widths shown - see chart for more information

2-Way In-Street Curb-Protected Bike Lanes

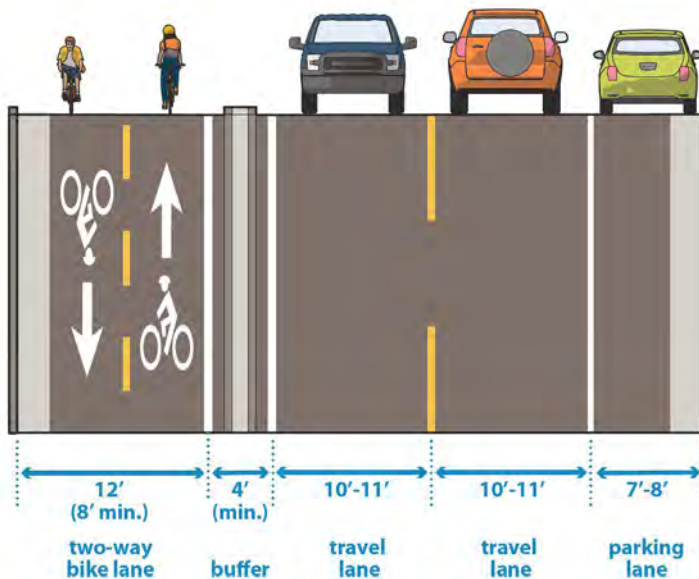

Preferred widths shown - see chart for more information

DESIGN CONSIDERATIONS

Follow all appropriate guidance for [delineator-protected bike lanes](#) with additional design considerations below.

A. Maintenance	Requires a minimum clearance of 6' between curbs to accommodate snow clearance/removal.
B. Bikeway curb width	Typical form-in-place curb width is 2'. Narrower curb designs can be used when the bike lane is not adjacent to a parking lane, but curbs are not recommended to be narrower than 9".
C. Curb reaction	A 1' curb reaction should be assumed on either side of the form-in-place curb, for a total minimum bike lane buffer width of 4' including the curb.
D. Striping	<ol style="list-style-type: none"> 1. The curb reaction distance should be reinforced on both sides of the curb with a single solid white longitudinal line for the length of the curb installation. 2. A cross-hatched buffer may also be utilized between the form-in-place curb and travel lane where excess roadway width exists.
E. Bollard placement	Plastic bollards should be placed at the beginning and end of each concrete curb section to inform winter maintenance operations.
F. Bikeway curb breaks	Should incorporate breaks for stormwater runoff and utility access covers where necessary depending on the characteristics on-site.
G. On-street to off-street transitions	May be designed to transition from on-street to sidewalk level in advance of intersections through the use of a slip ramp.
H. Parking lane considerations	<ol style="list-style-type: none"> 1. When a parking lane is located on the same side of the street as an in-street curb-protected bike lane, the parking lanes should be located between the bike lane buffer and travel lane, sometimes referred to as "floating" parking. 2. When locating a curb-protected bike lane adjacent to a parking lane, the concrete curb should be segmented into 15' curb segments with 6' gaps in between each segment to allow for easier pedestrian access across the concrete curb delineation and access to the nearest curb ramp via the bike lane.
I. Intersection guidance	See also bikeway intersection design guidance .

Sidewalk-level protected bikeways are at or near the elevation of the sidewalk and are physically separated from the roadway by a vertical curb.

INTRODUCTION

Sidewalk-level protected bikeways are at or near the elevation of the sidewalk and are physically separated from the roadway by a vertical curb. Sidewalk-level protected bike lanes are the preferred bikeway type for any street reconstruction project on a street identified as a low stress bikeway on the All Ages and Abilities Network where a shared use path or neighborhood greenway are unfeasible or not preferred. They may also be implemented as part of a roadway retrofit project, but other forms of protected bike lanes are more common in that scenario due to retrofit cost realities.



Sidewalk-level protected bike lanes on Washington Ave

Figure 3.4F.1:

Sidewalk-level protected bike lane dimensions table

Sidewalk-level Protected Bike Lane	Bike Lane			Buffer	
	Preferred Width (ft)	Minimum Width (ft)	Maximum Width (ft)	Minimum Width (ft)	Constrained minimum width to pedestrian clear zone (ft)
One-Way	6-7	5 ^{a b}	8	1.5 ^c	0.5 ^d
Two-Way	10-12	8	14		

a Constrained minimum widths should only be used for short stretches in constrained right-of-way where every consideration has been taken to narrow roadway street zones. Constrained minimum widths are inclusive of the gutterpan.

b A minimum combined bike lane and buffer width of 6' clear of any vertical obstructions must be maintained at all times to accommodate winter maintenance.

c 3' is recommended if buffer is adjacent to a parking lane; typical buffer without parked cars is 2' (or wider if the buffer has signs or other street furnishings).

d 1' or wider is preferred where possible.

3.4F Sidewalk-level protected bike lanes

Figure 3.4F.2:

Sidewalk-level protected bike lane dimensions graphic

1-Way Sidewalk-Level Protected Bike Lanes

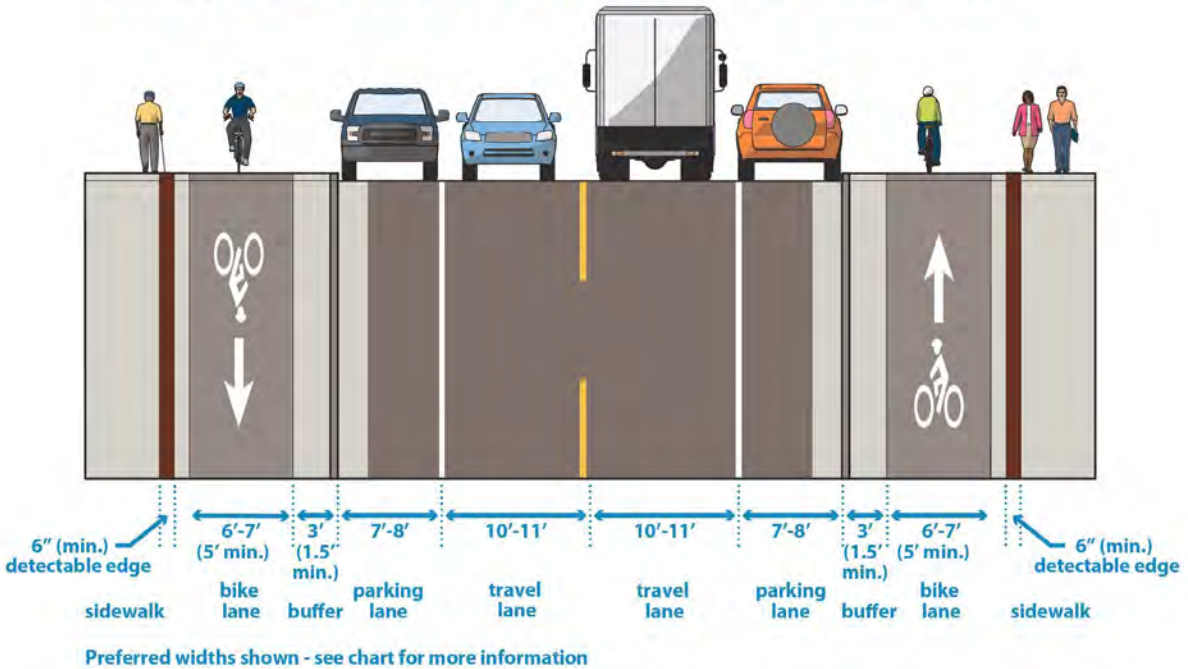

2-Way Sidewalk-Level Protected Bike Lanes

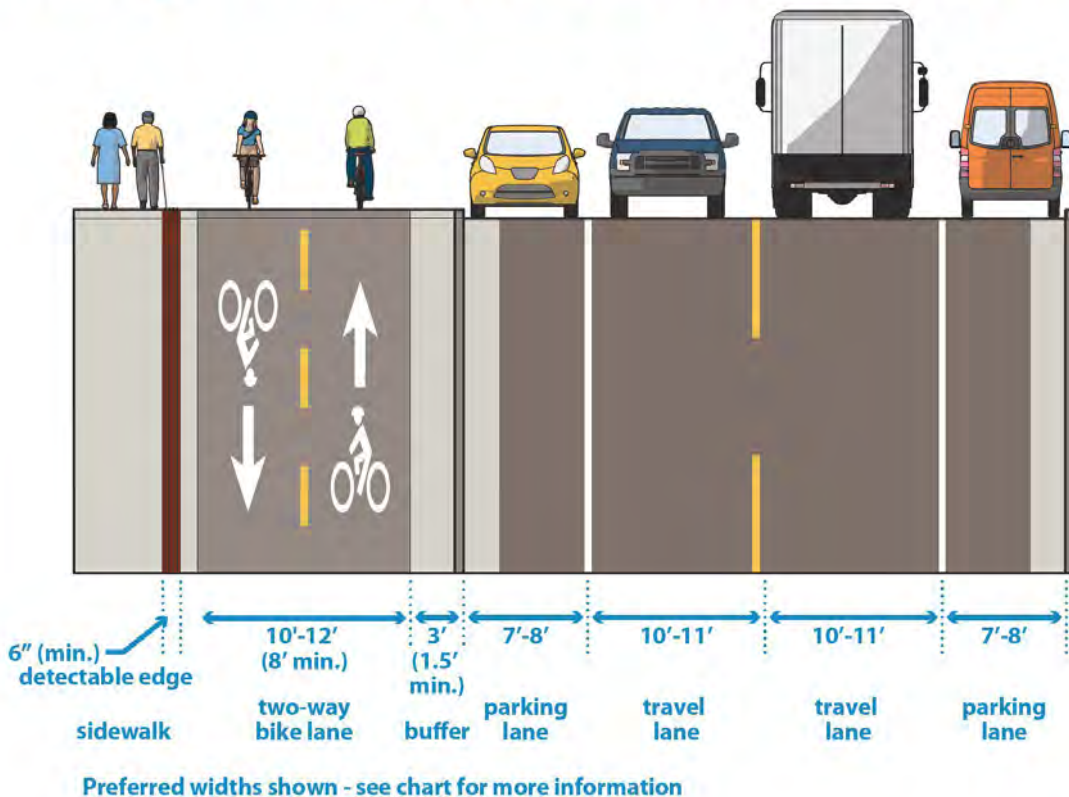

DESIGN CONSIDERATIONS

A. Operation	May be designed for one-way or two-way bicycle traffic.
B. On-street to off-street transitions	On-street protected or un-protected bike lanes may transition to sidewalk-level protected bike lanes by employing bicycle-specific slip ramps. For slip ramp transitions, a pedal-compatible adjacent curb height (2" or less) or a mountable curb should be pursued between the bikeway and sidewalk/furnishing zone.
C. Maintenance	A constrained minimum bikeway + buffer width of 6' is required to accommodate snow clearance/removal.
D. Greening	Buffer areas between the bike lane and roadway or sidewalk may be considered for greening where adequate space exists.
E. Buffer zones	<p>Sidewalk-level protected bike lanes should have buffers between both the roadway and pedestrian clear zone.</p> <ol style="list-style-type: none"> 1. Buffers may be either hardscaped or landscaped depending on available widths and adjacent land uses and curbside contexts. 2. On streets with higher pedestrian demand (e.g. Downtown Core and Mixed Use Commercial Connector streets), it's preferable to have wider buffer space between the pedestrian clear zone and the bikeway. On streets with relatively fewer potential conflicts between pedestrians and bicyclists, it's preferable to have wider buffer space between the roadway and bikeway. 3. Wider buffers are also preferred outside of downtown to allow for additional snow storage space between the bikeway and curb. 4. Sign posts, lighting, utilities, plantings, and street furniture may be located in the buffer areas. <ul style="list-style-type: none"> » 2' Minimum clearance generally should be maintained from fixed objects to the bikeway operating area. » 1' minimum clearance can be considered for contiguous installations like fencing or railings and for objects placed at bikeway stop locations. » See utilities and signs guidance or street lighting guidance for more details.
F. Materials	<ol style="list-style-type: none"> 1. When adjacent to a concrete sidewalk, the bikeway should use materials such as asphalt or colored concrete to visually differentiate the bikeway operating area from the sidewalk and adjacent buffer zones. 2. Care should be taken to ensure the bikeway maintains a smooth and rideable surface, including limiting utility access covers and handholes in the bikeway operating area, and saw-cutting concrete rather than tooling joints in the bikeway area. When locations for utility access or handholes cannot be accommodated outside of the bikeway operating area, utility covers, manholes, and handholes should be flush with the bikeway surface.

G. Detectable edge

In areas where a sidewalk-level bike lane is located adjacent to the pedestrian clear zone [link], a detectable edge (also referred to as a directional guideway) should be utilized to provide visual and tactile delineation between the sidewalk and bike lane.

1. The detectable edge should be a minimum of 6" wide (1' preferred) and should be located parallel to the bikeway between the pedestrian clear zone and bikeway.
2. The detectable edge should run to the corner bicycle and pedestrian mixing zone (link), but should not run through the corner mixing zones to prevent impacts to sloping grades, detectable ramps, APS push button placement, and to reinforce that pedestrians maintain the right of way in this area.
3. Preferred detectable edge designs are currently being piloted and are under evaluation. This guide will be updated to reflect the recommended directional guideway design elements once evaluation has been completed. Figure 3.4K shows details for one example design.

Figure 3.4F.3: Example of detectable edge between sidewalk level protected bike lane and sidewalk

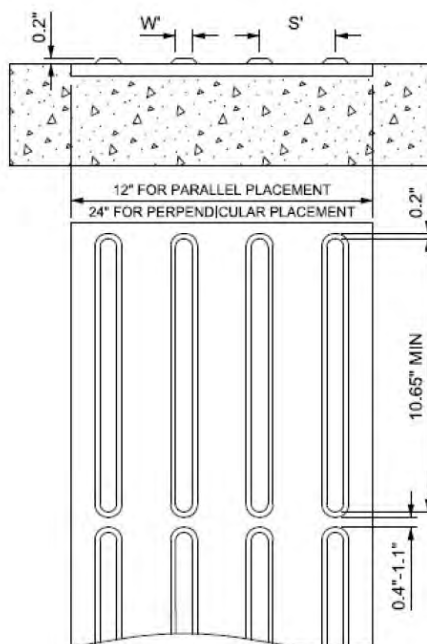

*Note that this detectable edge design is currently being piloted and is under evaluation.

H. Parking lane considerations

When locating a sidewalk-level protected bike lane adjacent to a parking or loading zone, a minimum buffer of 3' should be maintained between the back-of-curb and the bikeway to accommodate door zone conflicts. In loading zones and areas with high parking turnover, consider paving the buffer area to accommodate access from the parking/loading zone to the sidewalk.

I. ADA considerations

Designers should implement strategies to support ADA access to parking spots, bus stops, and Metro Mobility drop off points along protected bike lanes. Additional details will be forthcoming in a future update to the Street Design Guide.

J. Intersection guidance

See also [bikeway intersection design guidance](#).

3.4G Shared use paths

Shared use paths are off-street facilities physically separated from motorized traffic where people walking and biking share the same space.

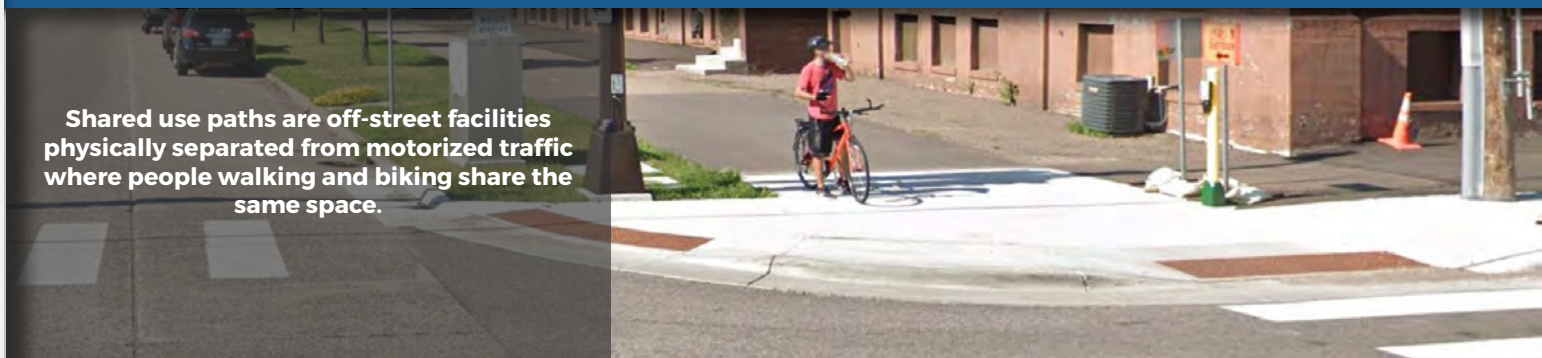

INTRODUCTION

Shared use paths are off-street facilities physically separated from motorized traffic where people walking and biking share the same space. Shared use paths are usually designed to accommodate two-way bicycle and pedestrian travel. In Minneapolis, many shared use paths are adjacent to existing roadways (sometimes referred to as “sidepaths”).

Protected bicycle lanes with separate sidewalk space for people walking and biking are preferred to shared use paths for every Street Type. Given the constrained right of way present on some corridors, however, achieving preferred separate biking and walking facilities may be impossible or impractical. In these cases, shared use paths should be considered. When considering shared use paths, the competing needs of the corridor should be evaluated to best support adopted city policies and prioritize the most vulnerable users of our roadways. Shared use paths are not appropriate for streets with high pedestrian and bicycle volumes. Shared use paths require intersection designs that safely accommodate bi-directional bicycle traffic.

Shared use paths with proper intersection designs are considered an All Ages and Abilities bicycle facility given their physical separation from motorized traffic and ability to appeal to a broad spectrum of people looking to travel by bike or micromobility.

Figure 3.4G.1:

Shared use path dimensions table

Shared Use Path			Horizontal Clearance		ADA				
			Signs & Obstructions	Contiguous features (railings/fences)	Grade	Cross slope			Pedestrian Access Route (PAR)
Preferred Width (ft)	Constrained Minimum Width (ft)	Maximum Width (ft)	Minimum Clearance (ft)	Minimum Clearance (ft)	Maximum %	Preferred (%)	Design Maximum (%)	Maximum (%)	Minimum Width (ft)
10-12	8 ^a	14.5 ^b	2 ^c	1	5	1	1.5 ^d	2	5

^a Constrained minimum widths should only be used for short stretches in constrained right-of-way where every consideration has been taken to narrow roadway street zones.

^b With 14.5' or more space, consider separate biking and walking facilities and look to protected bike lane guidance.

^c Less than 2' clearances can be accommodated at locations with stop conditions.

^d Cross slope design maximum of 1.5% to account for construction tolerances; 2% maximum cross slope on implementation.

Figure 3.4G.2:

Shared use path dimensions graphic

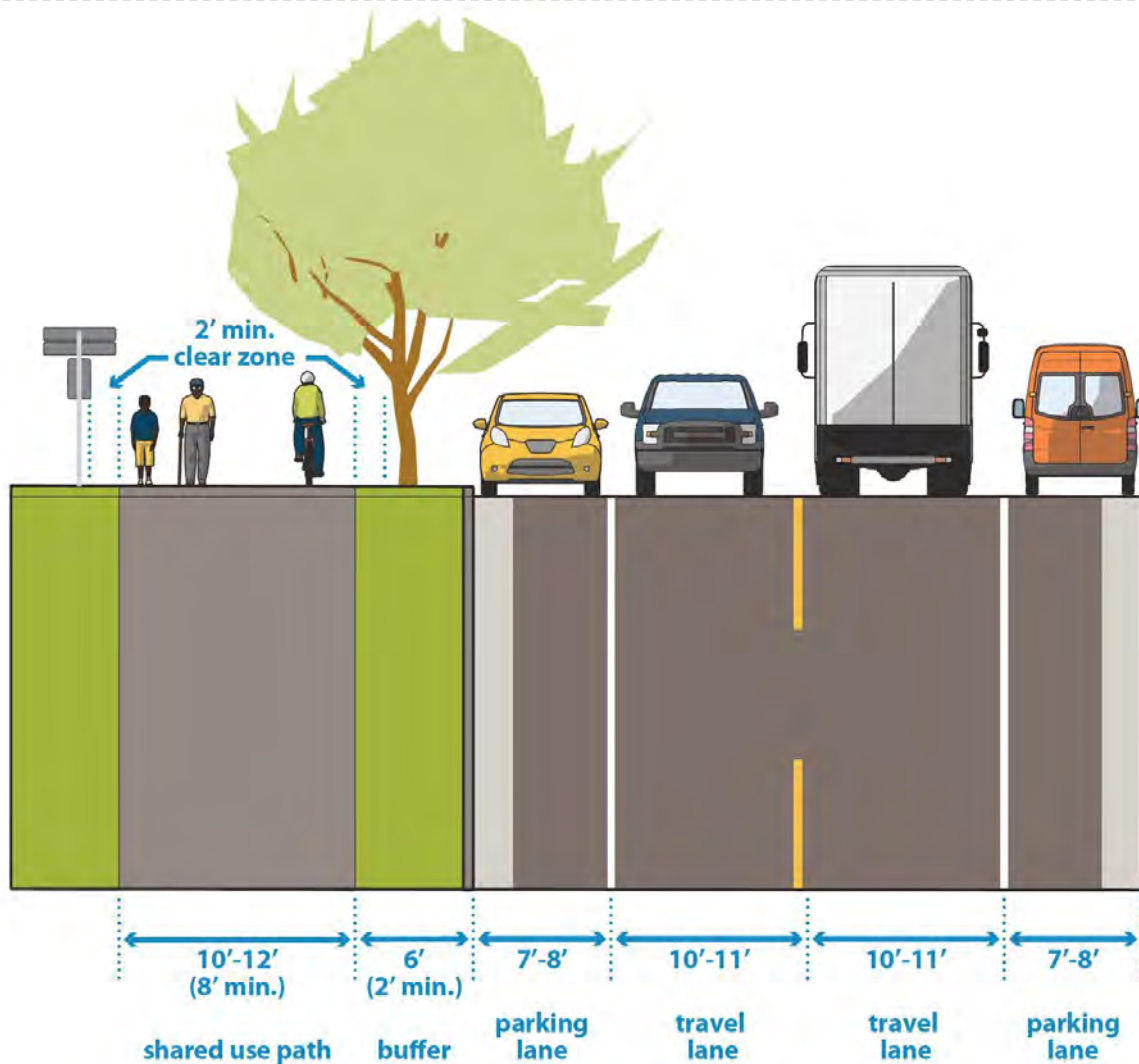

Preferred widths shown - see chart for more information

DESIGN CONSIDERATIONS

A. MnDOT guidance

Please reference [MnDOT's Bicycle Facility Design Manual](#) (pages 5-3 to 5-28) for specific geometric guidance and best practices on sidepath and shared use path design. The following design guidance is intended to supplement the information included in the MnDOT Bicycle Facility Design Manual.

B. Widths

Preferred widths for shared use paths are between 10' and 12'. Ideally path width should be wider in locations where high volumes of bicycle and/or pedestrian traffic is expected, with separate adjacent sidewalk facilities in locations where high non-motorized traffic volumes make pedestrian and bike/micromobility conflicts likely.

C. Materials

Shared use paths should use materials such as asphalt or colored concrete to visually differentiate the space from a conventional sidewalk.

D. Buffer

Shared use paths require a minimum buffer space of 2' from the edge of the path to the roadway, but buffer areas of 6 or more feet are preferred.

1. When buffer area is 3' or less, the buffer area should be paved as it may not be possible to maintain a vegetated buffer/boulevard area.
2. 2' of clearance is required from the edge of the shared use path to any sign or vertical obstruction, except for contiguous installations like fencing or railings that require a 1' minimum clearance from the path.

E. Visibility and safety

Visibility and safety. Since shared use paths are usually designed to accommodate two-way travel and incorporate a buffer or boulevard space between the path and adjacent roadway, it is important to prioritize user safety and visibility at all conflict points with motorized traffic. The MnDOT Bicycle Facility Design Manual recommends the following to increase safety:

- » Reduce conflict points;
- » Reduce motor vehicle speeds at conflict points;
- » Increase the predictability of path and roadway user behavior; and
- » Increase the path separation from the roadway at conflict points.

F. Intersection safety

Examples of treatments to support the MnDOT safety recommendations include:

- » implementing [raised pedestrian and bicycle crossings](#) at intersections;
- » altering intersection geometry and vertical obstructions to improve sight lines;
- » incorporating shared use path geometry such as a "bend out" trail design that supports adequate sightlines and user orientation across an intersection (see [protected intersections guidance](#) for more details);
- » making changes to signal timing to incorporate leading bicycle interval/leading pedestrian interval, or incorporate bike/pedestrian-only signal phases;
- » increasing the size of the buffer/boulevard area between the trail and adjacent roadway; and
- » potentially closing some intersections to eliminate modal conflict points.

G. Intersecting driveways

To maintain a consistent and comfortable user experience, shared use paths should attempt to maintain their elevations and cross slopes across intersecting driveways. Where possible, trail pavement materials should be continued across driveways to eliminate the need for horizontal expansion joints and provide additional visual delineation between the path and driveway surface.

H. ADA requirements and considerations

Shared use paths accommodate pedestrian traffic, and as a result, must maintain ADA-compliance throughout their limits. On mid-block path segments this requires a maximum grade of no more than 5%, a maximum cross-slope of 2% (though a maximum design cross slope of 1.5% is required to accommodate construction tolerances), and a minimum pedestrian access route (PAR) of 4'. At intersections, this includes detectable warnings and ramps at all intersecting streets, with ramp widths designed to match the width of the shared use trail. For additional ADA considerations and details, please reference the [MnDOT Bicycle Facility Design Guide](#) (page 5-26).

Neighborhood greenways are low-stress All Ages and Abilities bicycling routes installed on low-volume Urban Neighborhood streets.



INTRODUCTION

Neighborhood greenways are low-stress All Ages and Abilities bicycling routes installed on low-volume **Urban Neighborhood** streets. Design treatments for neighborhood greenways are intended to manage motor vehicle volume and speed while optimizing travel for people walking, biking, and rolling. There are two types of neighborhood greenways: full neighborhood greenways and bicycle boulevards.

- A full neighborhood greenway adds a dedicated trail to an Urban Neighborhood street while limiting or eliminating access to motor vehicles. A full greenway can often be implemented in combination with green infrastructure improvements and/or park-like amenities. A full greenway may also reduce a typical Urban Neighborhood street by half and retain one way motor vehicle travel and one parking lane. Examples of full greenway in Minneapolis include Milwaukee Ave, 37th Ave N Greenway, and a portion of 18th Ave NE between University Ave and 5th St.
- Bicycle boulevards are enhanced Urban Neighborhood streets that give priority to pedestrians and bicyclists, including traffic and speed management measures such as diverters, speed bumps, curb extensions, median refuge islands, and traffic circles. Bicyclists typically share traffic-calmed space with motor vehicles. Examples of bicycle boulevards in Minneapolis include the 5th Street Northeast Bike Boulevard and the 40th Street River-Lake Greenway.

A neighborhood greenway may include a combination of full neighborhood greenway and bicycle boulevard segments based on available right of way, community input, cost, availability of alley access, parking demand, and the need for green infrastructure to mitigate flooding.



A full neighborhood greenway adds a dedicated trail to an Urban Neighborhood street while limiting or eliminating access to motor vehicles.

INTRODUCTION

A full neighborhood greenway adds a dedicated trail to an [Urban Neighborhood](#) street while limiting or eliminating access to motor vehicles. Full greenways can be implemented with a retrofit or street reconstruction project. Full greenways are considered All Ages and Abilities bikeways. There are two typical ways to implement full greenways:

- A 2-way trail adjacent to a street with limited/reduced motor vehicle access or parking; or
- A 2-way trail with no adjacent motor vehicle access.

GENERAL DESIGN CONSIDERATIONS

A. Bicycle priority	Neighborhood Greenways should prioritize travel by bicycle and disincentivize through travel by motorized traffic.
B. Connections	Full greenways should be part of a linear bikeway with logical beginning and end points, typically connecting to other bikeways on the All Ages and Abilities Network as they are installed.
C. Combining with bike boulevards	Full greenways may be used in combination with elements of bicycle boulevards depending on available right of way, community input, cost, availability of alley access, parking demand, and the need for green infrastructure to mitigate flooding. Some blocks may fully remove motor vehicle access, others may narrow the vehicular travel space by half and other blocks could primarily focus on intersection treatments such as curb extensions, median refuge islands, and traffic circles.
D. Flood mitigation	Full neighborhood greenways may also be used for flooding and stormwater management mitigation.

FULL GREENWAY WITH LIMITED LOCAL MOTOR VEHICLE ACCESS

A full neighborhood greenway can be implemented by converting some of the existing roadway space to a 2-way trail separated from vehicle traffic by planters or delineators. This can be a good option for blocks on a neighborhood greenway route where fully removing motor vehicle traffic is not feasible or supported by community members.

Figure 3.4I.1:

Neighborhood greenway retrofit example

Neighborhood Greenways: Full Greenways Before

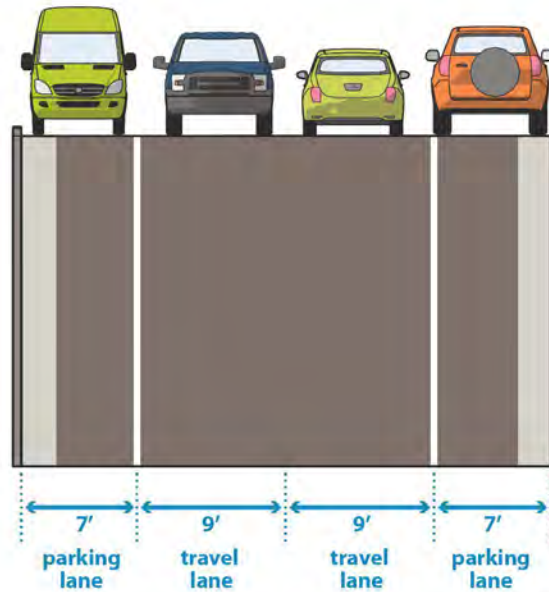

Neighborhood Greenways: Full Greenways After

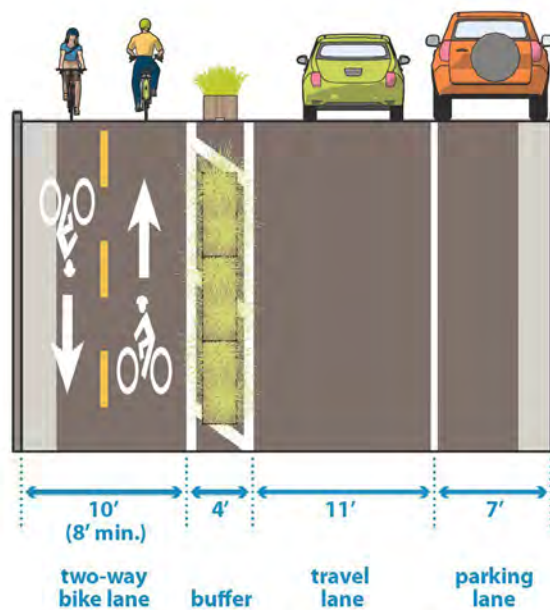

Design considerations if implementing with a street retrofit

Follow all appropriate guidance for [delineator-protected bike lanes](#) or [planter-protected bike lanes](#).

E. Lane configuration	Retaining one-way motor vehicle traffic with one-side vehicle is the preferred way to implement a full neighborhood greenway while retaining local motor vehicle access. On blocks with very low parking demand, a two-way street with no parking can be considered; this option is typically not preferred because it increases the risk that drivers will park in the bikeway. 18'-20' is required for either a one-way street with parking on one side or a two-way street with no parking (for Urban Neighborhood streets).
F. Buffer zone width	The buffer zone between 2-way bikeway and travel lane should be 2'-5' wide if using delineators and 4' wide or wider if using planters.
G. Bikeway width	The 2-way bikeway should be 10'-14' wide, including the gutter pan. In constrained right of way, a 2-way bikeway of 8' can be considered for short stretches. The bikeway will be implemented in the roadway.
H. Manage parking in bikeway	Consider elements that reduce the likelihood of drivers parking in the bikeway, including using planters rather than delineators, increasing delineator spacing, and including a delineator in the middle of the bikeway at access points.
I. Diverters	Consider alternating the direction of one-way traffic periodically to further reduce traffic volumes and allow the possibility of eliminating interactions between bicyclists and motor vehicles at intersections as shown in Figure 3.4O.
J. Crossings	Include crossing improvements for the bikeway at busier streets and consider at other streets; options include traffic signals, bicycle and pedestrian safety islands , curb extensions , and/or Rectangular Rapid Flashing Beacons. See NACTO's Urban Bikeway Design Guide for additional options and page 5-15 of the MnDOT Bicycle Facility Design Manual for additional details on trail design at intersections. Coordinate with Traffic and Parking Services to consider appropriate treatments at a given location.

Additional design considerations if implementing with a full or partial street reconstruction

Follow design considerations for neighborhood greenways with limited local vehicle access street retrofits.

K. Sidewalk-level bikeway	The two-way bikeway should be implemented at sidewalk level and should typically be 10' to 14'. The bikeway design should accommodate emergency and maintenance vehicle access.
L. Green stormwater infrastructure	Consider the best way to incorporate green stormwater infrastructure . That may be including a green buffer between the bikeway and the roadway or a slightly narrower paved buffer and a slightly wider boulevard area.
M. Raised crossings	Raised pedestrian and bicycle crossings should generally be included when the bikeway crosses an Urban Neighborhood street; curb extensions should generally be included whenever there is parking

Figure 3.4I.2:

Neighborhood greenway example with 1-way traffic and 1-side parking



FULL GREENWAY WITH NO ADJACENT MOTOR VEHICLE ACCESS

A full neighborhood greenway can be implemented on a street that is closed to motor vehicles. This would typically be implemented in combination with flood mitigation improvements and/or park-like amenities as shown in Figure 3.4P.

N.

Designers should generally use the [trail guidance](#) to inform the design details for a full greenway with no motor vehicle access.

3.4I Neighborhood greenways: full greenways

Figure 3.4I.3:

Neighborhood greenway example with no adjacent motor vehicle access

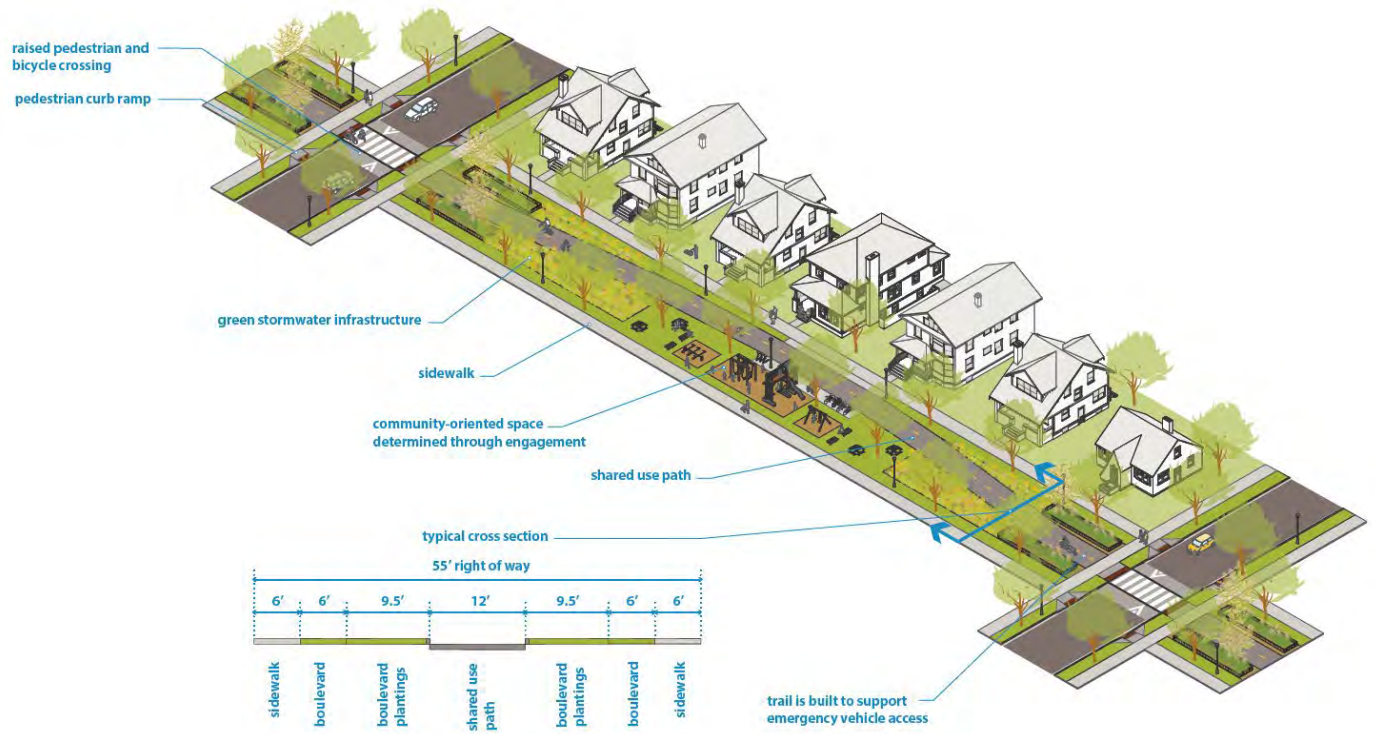



Bicycle boulevards are enhanced Urban Neighborhood streets that give priority to pedestrians and bicyclists.

INTRODUCTION

Bicycle boulevards are enhanced [Urban Neighborhood](#) streets that give priority to pedestrians and bicyclists, including traffic and speed management measures such as diverters, speed bumps, curb extensions, median refuge islands, and traffic circles. Bicyclists typically share traffic-calmed space with motor vehicles. Bicycle boulevards are typically implemented with a retrofit project, but may be considered with a full street reconstruction in certain cases. Bicycle boulevards are considered All Ages and Abilities bikeways.

DESIGN CONSIDERATIONS

A. Traffic calming

Bicycle boulevards should be designed to discourage and slow motor vehicle traffic while retaining local access. A combination of treatments should be considered depending on the current traffic speeds and volumes. Options include:

1. Traffic diverters designed to allow bicycles to pass;
2. [Traffic circles](#);
3. Speed humps or [raised pedestrian and bicycle crossings](#);
4. One-way streets with [contraflow bicycle lanes](#); and
5. [NACTO's Urban Bikeway Design Guide](#) has additional options that can be considered.

B. Crossings

Include crossing improvements for the bikeway at busier streets; options include traffic signals, bicycle and [pedestrian safety islands](#), [curb extensions](#), and/or Rectangular Rapid Flashing Beacons. See [NACTO's Urban Bikeway Design Guide](#) for additional options and details. Coordinate with Traffic and Parking Services to consider appropriate treatments at a given location.

C. Bicycle improvements

Bicycle boulevards should also make bicycling more attractive, including reducing the need for bicyclists to stop. Typical elements include:

1. Traffic circles with yield signs rather than stop signs; and
2. Bicycle Blvd pavement markings, wayfinding signs, and bikeway street signs; see [NACTO's Urban Bikeway Design Guide](#) for additional details.

Figure 3.4J.1:
Bicycle boulevard example



3.4K Bike lanes, unprotected

Bike lanes provided dedicated space in the roadway through signing and striping for people to bike or travel via micromobility.



INTRODUCTION

Bike lanes provided dedicated space in the roadway through signing and striping for people to bike or travel via micromobility. Bike lanes or buffered bike lanes may be considered with any street retrofit project that overlaps with the [All Ages and Abilities Network](#). Unprotected bike lanes should generally not be used for street reconstruction projects as they are not low-stress All Ages and Abilities bikeways.

Figure 3.4K.1:

Bike lane dimensions table

Bike Lane	Preferred Width (ft)	Minimum Width (ft)
Adjacent to parking lane	6-7	5
Adjacent to curb (including 2' gutter pan)	6-7	6

Figure 3.4K.2:

Bike lane dimensions graphic

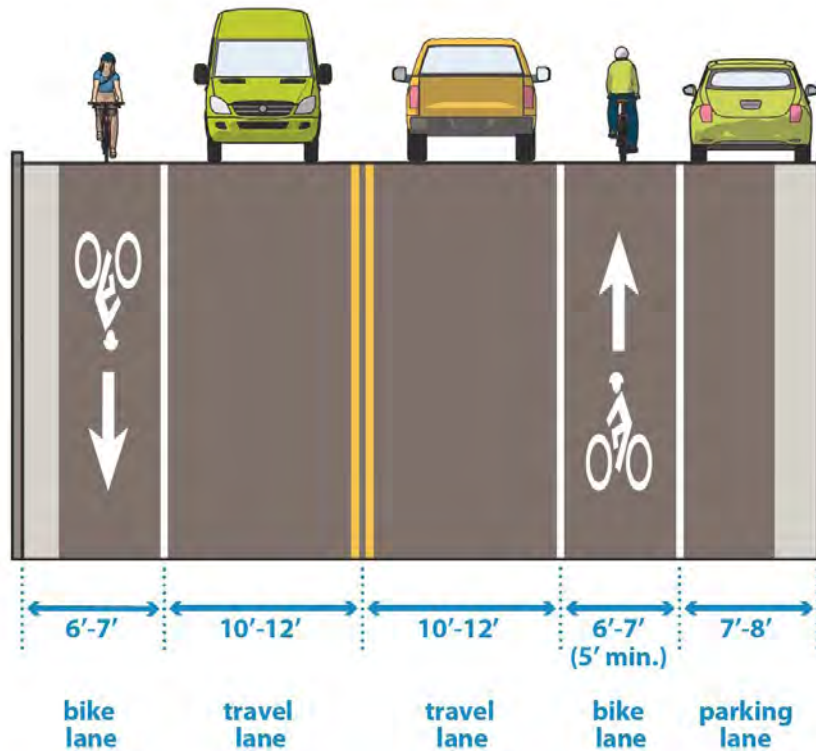

Preferred widths shown - see chart for more information

DESIGN CONSIDERATIONS

A. Operation	Bike lanes are intended for one-way travel and are typically provided on both sides of two-way streets, and on one side of one-way streets.
B. Dimensions	<ol style="list-style-type: none"> 1. Preferred width for bike lanes is 6-7 feet, and the constrained minimum width is 5 feet. 2. Bike lanes directly adjacent to the curb should include a minimum of 4 feet of smooth, rideable surface, excluding any adjacent gutter pan. 3. Wider bike lanes are preferred in environments with higher traffic volumes, higher traffic speeds, corridors with a high percentage of heavy vehicles, and where adjacent parking utilization and/or turnover is high. 4. When bike lanes are adjacent to parking lanes, bike lanes should be 6 to 7 feet wide to reduce door zone conflicts. Consider buffered bike lanes or wider parking lanes (8' or wider) where feasible for improved winter maintenance of the bike lane.
C. Space constrained locations	Where space is constrained adjacent to a curb extension, a modified B612 (1') curb may be used for short durations to maintain additional smooth rideable bike lane surface. Locations for installing modified B612 must be reviewed and approved by Surface Water and Sewers before installation.
D. Maintenance	Reliable snow and ice clearance/removal for standard unprotected bike lanes is challenging, especially when located adjacent to a parking lane.
E. Intersection guidance	See also bikeway intersection design guidance .

3.4L Buffered bike lanes, unprotected

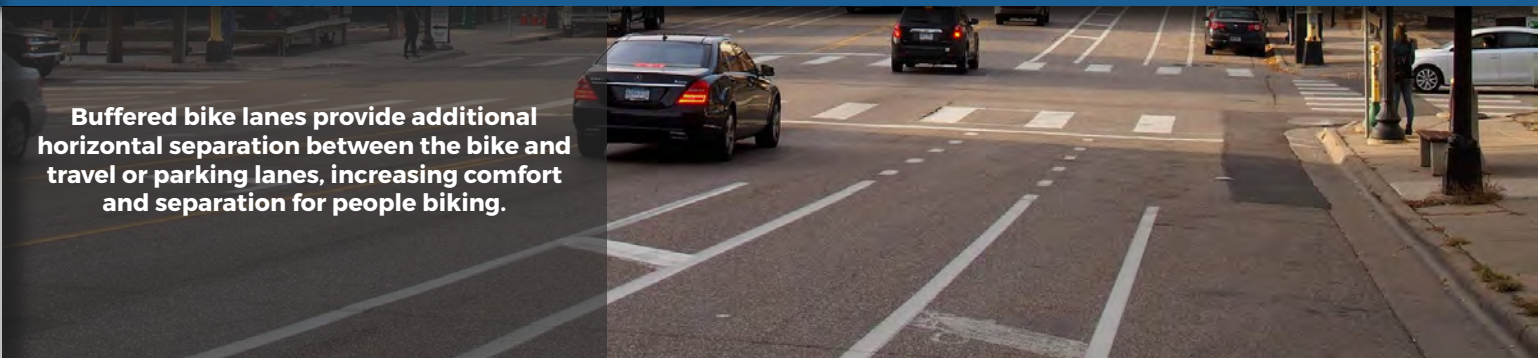

Buffered bike lanes provide additional horizontal separation between the bike and travel or parking lanes, increasing comfort and separation for people biking.

INTRODUCTION

Buffered bike lanes provide additional horizontal separation between the bike and travel or parking lanes, increasing comfort and separation for people biking.

Bike lane buffers should be considered in scenarios where excess roadway space allows for bike facilities wider than 7 feet. Bike lanes or buffered bike lanes may be considered with any street retrofit project that overlaps with the All Ages and Abilities Network. Unprotected bike lanes should generally not be used for street reconstruction projects as they are not low-stress All Ages and Abilities bikeways.

Figure 3.4L.1:
Buffered bike lane dimensions graphic

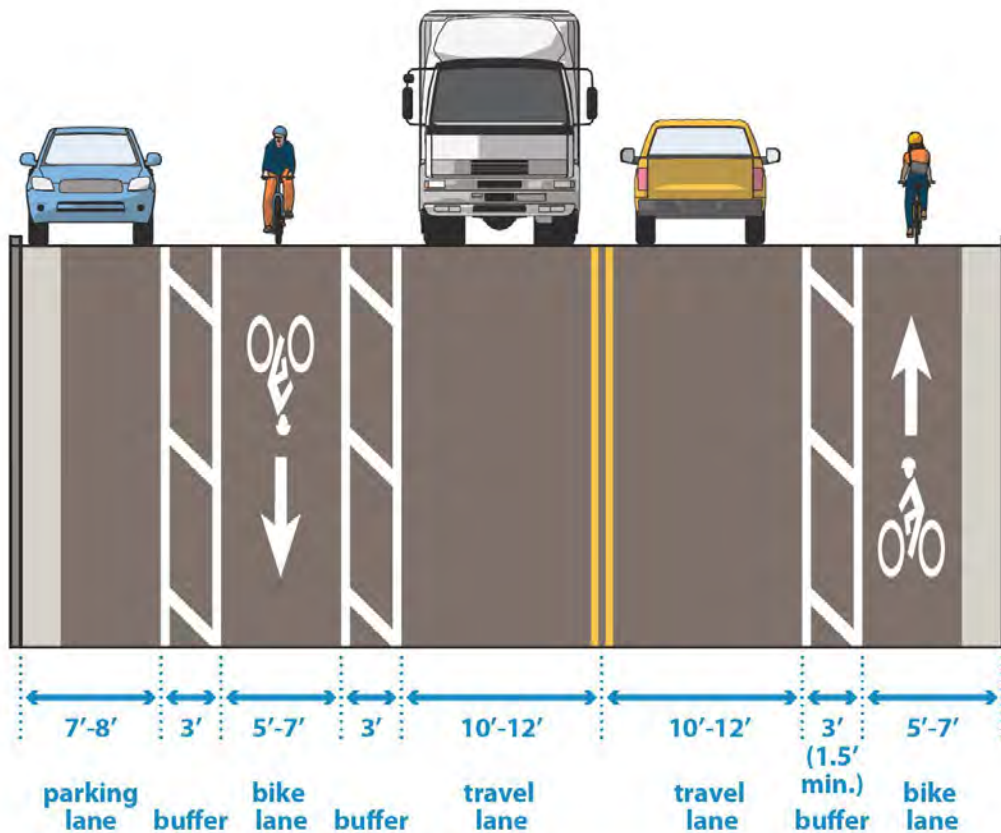

Preferred widths shown - see chart for more information

DESIGN CONSIDERATIONS

A. Dimensions	<ol style="list-style-type: none"> 1. Buffered bike lanes should be considered when there is space to implement bike facilities exceeding 7 feet in width (inclusive of the gutter pan) if there is not an adjacent parking lane. 2. Buffers should be a minimum of 1.5 feet wide. There is no maximum buffer width, although buffers wider than 4 feet are rare.
B. Cross hatching	<p>Buffers wider than 2' require cross hatching at 20' to 60' spacing. 2-foot or narrower buffers do not require cross hatching.</p>
C. Width considerations	<p>Due to the lack of vertical delineation, buffers may be considered part of the overall bike lane width.</p>
D. Maintenance	<p>Reliable snow and ice clearance/removal for buffered unprotected bike lanes is challenging, especially when located adjacent to a parking lane.</p>
E. Intersection guidance	<p>See also bikeway intersection design guidance.</p>

3.4M Contraflow bike lanes

Contraflow bike lanes accommodate bicycle travel in the opposite direction of motor vehicle traffic, allowing for two-way accessibility for bicycles on one-way streets.



INTRODUCTION

This treatment is best suited for low-speed, low volume roadways, unless physical protection is provided between the bikeway and adjacent travel lane. Contraflow bike lanes should be considered on corridors where there are few alternate routes that provide similarly convenient travel for people biking, narrow one-way neighborhood greenway streets, and on streets where existing contraflow riding is regularly observed.

Figure 3.4M.1:

Contraflow bike lane dimensions graphic

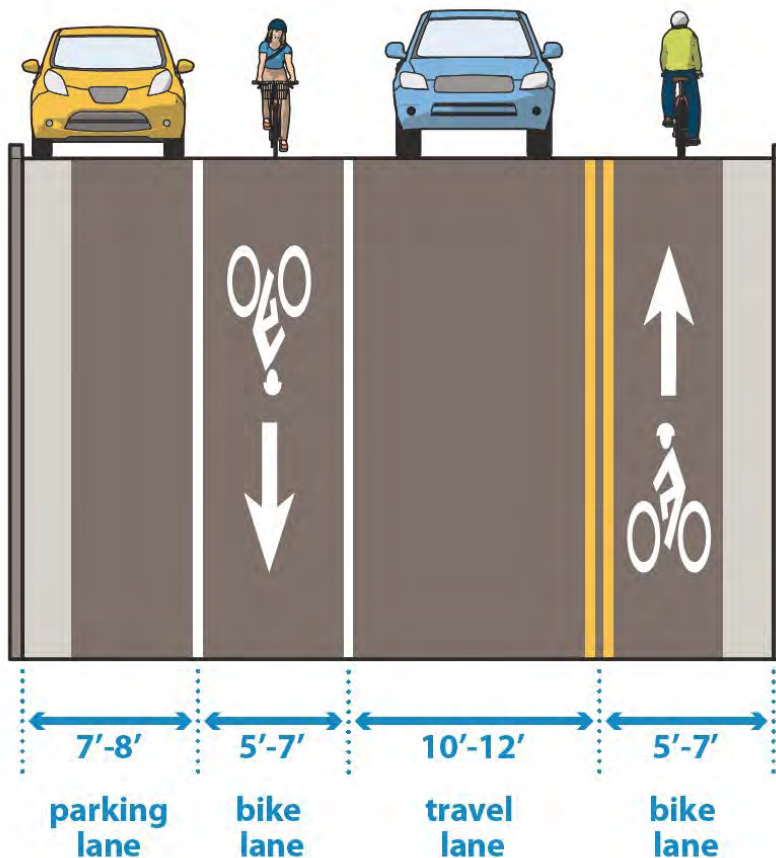

Preferred widths shown - see chart for more information



**Contra-Flow Bike Lanes on
5th St SE**

DESIGN CONSIDERATIONS

A. Striping

1. Contraflow bike lanes are typically separated from adjacent travel lanes by solid double yellow lines throughout the full block.

» On low volume Urban Neighborhood streets, contra-flow bicycle travel may also be implemented with signage and no striping, or with solid double yellow lines only at the beginnings of a block that does not continue mid-block. Contraflow facility design without contiguous striping should be closely coordinated with Traffic and Parking Services.

2. Green conflict zone markings maybe considered at intersections to alert motorized traffic to contraflow bike movements.

B. Conditions for physical protection

Contra-flow bike lanes should be physically protected when adjacent to streets with a posted speed limit above 25mph or high traffic volumes. See [protected bike lane guidance](#) for more details.

C. Signage

An “EXCEPT BIKES” plaque are typically posted beneath “DO NOT ENTER” signs (R5-1) or turn prohibition signs, if present, to permit two-way traffic use by bicycles at all street intersections.

D. Parking.

When a parking lane is located on the same side of the street as a contraflow bike lane, the parking lanes should be located between the bike lane and travel lane (sometimes referred to as “floating” parking). Floating parking should always be implemented with vertical delineation as a component of a [protected bikeway](#).

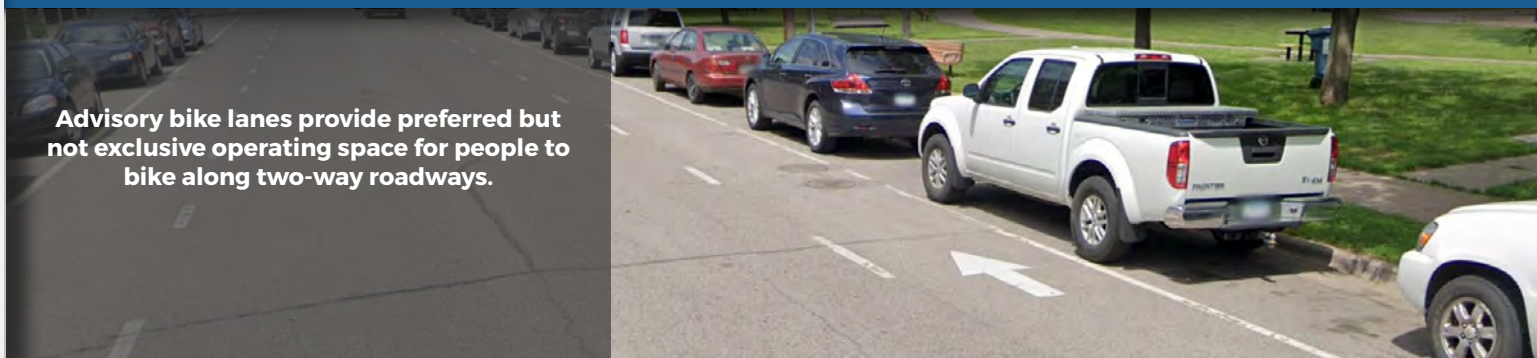

Advisory bike lanes provide preferred but not exclusive operating space for people to bike along two-way roadways.

INTRODUCTION

Advisory bike lanes provide preferred but not exclusive operating space for people to bike along two-way roadways. Unlike standard bike lanes, advisory lanes allow cars to merge into the bike lane area when approaching an oncoming vehicle and when people biking are not present.

Advisory bike lanes are considered an experimental treatment by the FHWA and may only be implemented through the Request to Experiment (RTE) process.

Designers should consider these factors when determining if an advisory bike lane is appropriate in an individual context:

Advisory bike lanes should only be considered in retrofit street projects where there is not enough space to install bike lanes and a neighborhood greenway is unsuitable or not preferred. Advisory bike lanes require less space than traditional bike lanes as a result of the shared center travel area and ability for vehicles to merge into the bike lanes when bikes are absent.

Advisory bike lanes are only suitable for roadways with low to moderate volumes and speed (25 MPH or lower).

Advisory bike lanes are unlikely to function well if parking is retained and parking utilization is low.

DESIGN CONSIDERATIONS

A. Striping

1. Advisory bike lanes should be striped with a solid white line when adjacent to a parking lane and dashed white line on the side adjacent to the travel lane, indicating that vehicles may carefully merge into the bike lane when necessary when bicycles are absent.

2. Advisory bike lanes are installed without a centerline in the vehicular travel area.

B. Dimensions

1. The advisory bike lanes should be 5'-6' wide.

2. The vehicular travel area between advisory bike lanes should be 14'-19'.

C. Intersection guidance

See also [bikeway intersection design guidance](#).

3.4N Advisory bike lanes

Figure 3.4N.1:

Advisory bike lane dimensions graphic

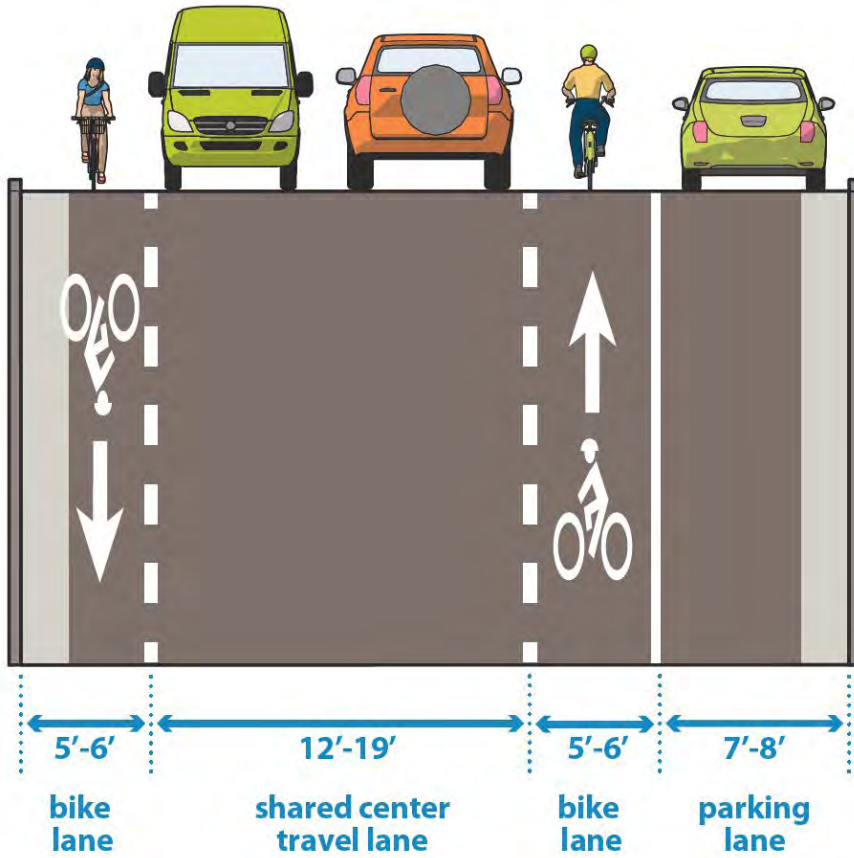

Transit is a critical foundation for the city's multimodal transportation system.

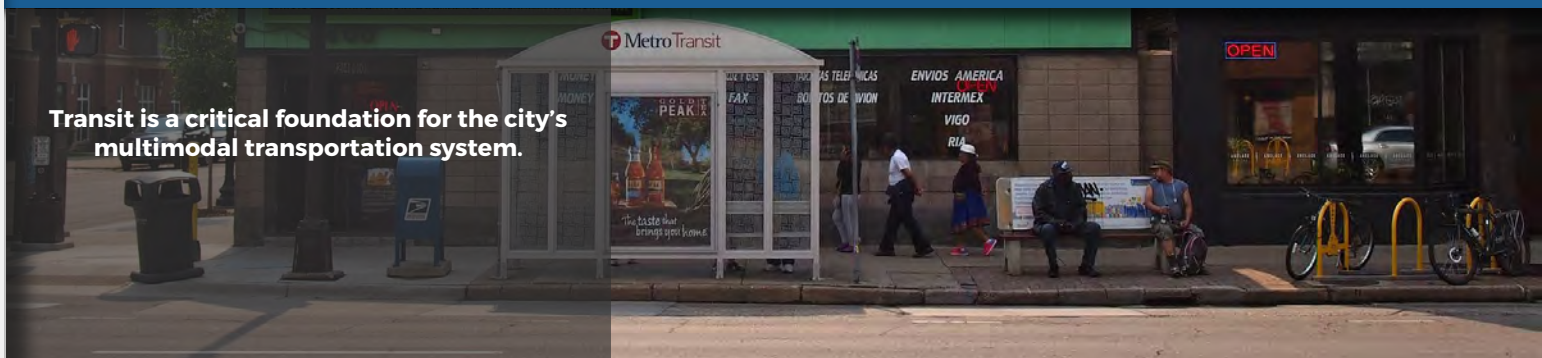

TRANSIT STOPS INTRODUCTION AND GENERAL GUIDANCE

Transit is a critical foundation for the city's multimodal transportation system. Metro Transit typically installs and maintains the transit stops throughout Minneapolis and the region; a few transit stops in Minneapolis are maintained by other transit providers. Public Works collaborates with Metro Transit and other providers on the location and design of transit stops in City right of way as well as on new service and operations of transit on City streets. Public Works installs and maintains bus stop signs.

TRANSIT ROUTES AND TRANSIT PRIORITY PROJECTS

The transit route network includes local bus, express bus, bus rapid transit, and light rail transit routes operated by Metro Transit or other transit providers. Transit Priority Projects identified by the City of Minneapolis in the Transportation Action Plan includes corridors identified for improvements to frequency and reliability on existing routes and identifies where new crosstown services are needed.

Types of transit stops

There are four general types of transit stops:

- Regular-route bus stops served by local and express service with or without a shelter;
- Bus Rapid Transit stations, the vast majority of which have shelters and other customer amenities;
- Light Rail Transit stations. Details for LRT stations are not covered in this guidance.
- Northstar Commuter Rail stations. Details for commuter rail stations are not covered in this guidance.

Related guidance

- [3.6E Bus-only lanes](#)
- [3.6F In-lane bus stops](#)
- [3.5D Bus stops and bikeways](#)

Regular-route bus stops are served by local and express bus service and are the most common in the transit system.

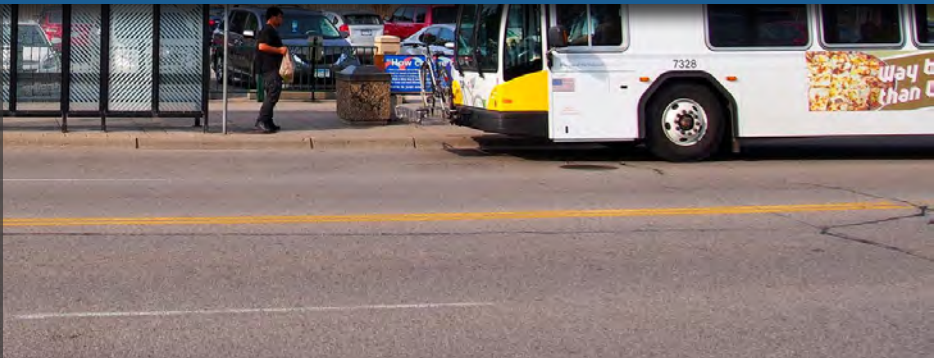

INTRODUCTION

Regular-route bus stops are served by local and express bus service and are the most common in the transit system. Stops that are planned for future Bus Rapid Transit service should use the Bus Rapid Transit stations guidance. [Metro Transit's Shelter Guidelines](#) cover placing and removing bus shelters, shelter lighting, and shelter heating. Additional details on Metro Transit shelter placement are [available here](#). Designers should work with Metro Transit and Traffic and Parking Services staff to determine preferred locations for bus stops and shelters on any street reconstruction project while balancing other demands in the corridor.

DESIGN CONSIDERATIONS

A. Accessible boarding area

At the front door zone of every bus stop, a concrete accessible boarding area must be provided for ADA access. It must have a clear length of 8' minimum, measured perpendicular to the curb or roadway edge, and a clear width of 5' minimum, measured parallel to the roadway (see figure 3.5B.1). This space is where passengers enter and exit the bus, and where bus operators deploy the lift for passengers using a mobility device, such as a wheelchair.

Figure 3.5B.1: Accessible boarding area (ADA pad)

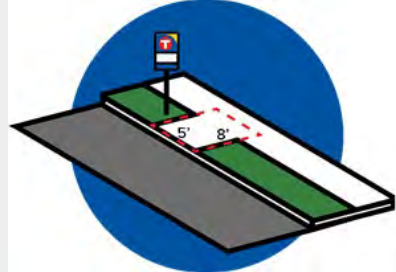

Source: Metro Transit

B. Back-door access zone

A back-door access zone is also preferred. Designers should collaborate with Metro Transit to determine if 40'-long buses or 60'-long articulated buses serve the corridor to locate boarding areas appropriately. Figure 3.5B.2 shows the door zones at local bus stops with common Metro Transit buses serving local routes. See also bus stop clear space.

Figure 3.5B.2: Door zones and bus stop clear space at local bus stops with common Metro Transit buses

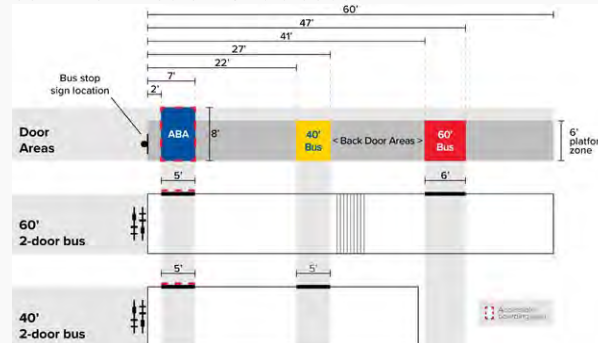

Source: Metro Transit

C. Bus stop sign

The bus stop sign indicates where bus operators will stop, where people will wait, and where passengers will enter/exit the bus. Metro Transit bus stop signs are site specific and include the unique bus stop ID, route number of buses serving the stop, and NexTrip information (see Figure 3.5B.3).

1. The bus stop sign should be located adjacent to the accessible boarding area; it should not obstruct the accessible boarding area. The bus stop sign can be installed in grass or a paved surface.
2. Construction projects that impact an existing or future bus stop should coordinate with Metro Transit to ensure sign and pole are located specifically to anchor the bus stop zone.

Figure 3.5B.3: Metro Transit local bus stop sign example

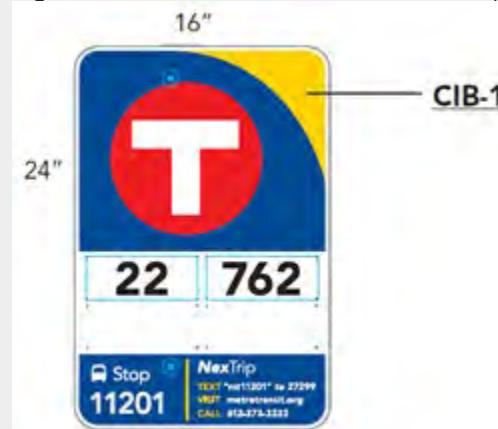

Source: Metro Transit

D. Preferred bus stop clear space

1. The bus stop clear space includes the bus stop sign, accessible boarding area, space for a shelter, and other streetscape amenities.
2. A 6' wide bus stop clear space behind the curb along the full length of the bus stop area is preferred to serve passengers waiting, queuing, and exiting the bus (see Figure 3.5D).
 - » The bus stop clear zone may be longer than one bus if the stop is designed for two buses if the stop is designed for two buses to serve the stop simultaneously.
 - » A full length 6' bus stop clear space may not always be feasible or preferred depending on bus loading and unloading volumes and other demands in the area, including pedestrian clear zone, protected bike lane, and greening.
 - » The bus stop clear space may also be combined with the pedestrian clear zone for the sidewalk (see [sidewalk zone design guidance](#) for more details).
3. The bus stop clear space is generally free of vertical obstructions with the exception of bus shelters, trash/recycling receptacles, benches, lighting, and columnar trees. This helps ensure that transit riders exiting through the rear door can do so without obstruction or difficulty.
 - » Common street furniture items that improve the public realm but should generally be located outside of the bus stop clear zone include: landscaping boxes and planters, e-scooters, bikes and bike racks, café and patio seating, and retail sandwich boards.
 - » Shoveled snow should be stored outside the bus stop clear zone.
 - » Pavers are discouraged in the bus stop clear zone as they can heave and become trip hazards. Additionally, Metro Transit shelters cannot be installed on pavers.
 - » Adjacent development or other roadway construction projects can impact the bus stop clear zone. Projects should coordinate with Metro Transit for replacing the bus stop.
 - » See also guidance for [placement of elements in the sidewalk zone](#).

Figure 3.5B.4: Bus stop zone with shelter location options

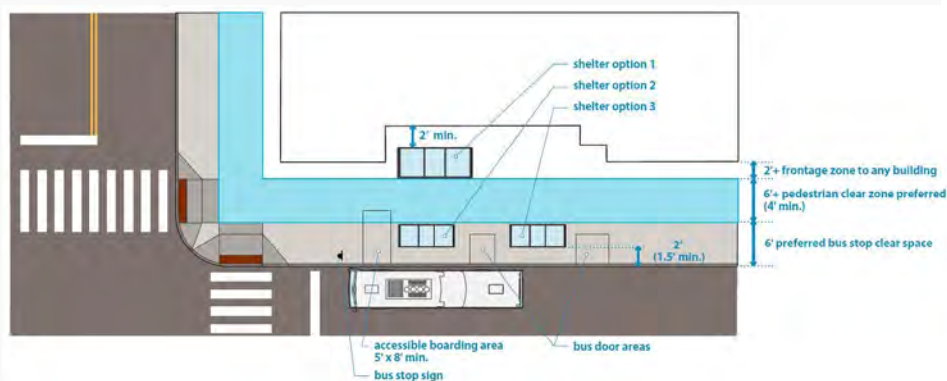

E. Shelter location and design

1. Shelter placement. Figure 3.5B.4 shows three common shelter placement options. Shelters can be placed in the frontage zone or boulevard and furniture zone, depending on demands in the corridor. Locating the shelter in the frontage zone is typically preferred, but is often not possible because of constraints (see [sidewalks guidance](#) for additional details on the frontage zone and boulevard and furniture zone).

- » If a shelter is being sited with its back to the curb (up against a travel/parking lane), it needs to be setback from the face of curb 1.5'-2' to avoid conflict with bus mirrors.
- » If a shelter is being sited with its back to a building or retaining wall, it needs to be setback from the structure by 2' to ensure technicians are still able to maneuver between the structures to change glass panels.
- » If a shelter is being sited immediately adjacent to a protected bike lane, shared use path, or trail where people will be biking, a 2' clearance should generally be used between the shelter and the bikeway, although narrower can be considered in constrained situations. See [guidance for bus stops and bikeways](#) for more information.

2. Shelter options. Metro Transit's shelters vary in length and depth from 2' x 8' to 6' x 12'. [See here for detailed shelter options.](#)

3. Pedestrian access.

- » Designers should work to maintain recommended pedestrian clear zone and frontage zone widths adjacent to shelters as outlined in the [sidewalk zone design guidance](#). A 6' or wider pedestrian clear zone is recommended for every street type. In constrained environments, narrower than 6' can be considered although every effort should be made to retain at least 5' pedestrian clear zone width. A minimum of 4' wide pedestrian clear zone must be maintained throughout to serve as the ADA-required pedestrian access route, although this should only be used in rare situations for short stretches in constrained right of way where every consideration has been taken to narrow all other street zones.
- » A minimum of 6' of sidewalk width (frontage zone and pedestrian clear zone together) is required between a building and a vertical object like a transit station to meet ADA requirements, although this minimum should only be used in rare constrained situations.
- » Whenever possible, a straight pedestrian clear zone should be maintained adjacent to transit shelters.
- » The bus stop clear space boarding area and the pedestrian clear zone can be combined and the shelter can be placed in the frontage zone along the edge of the street right of way.

Bus Rapid Transit (BRT) stations should be used when there is a current or planned Bus Rapid Transit stop.



INTRODUCTION

Bus Rapid Transit (BRT) stations should be used when there is a current or planned Bus Rapid Transit stop. If a street reconstruction project is on a planned future BRT line, designers should work with Metro Transit staff to determine the timing of phased improvements. BRT-ready bus stops may be considered ahead of full BRT corridor construction. If full BRT-ready bus stops are infeasible, planning for future BRT in placement of curbs, clearance/site dimensions, and underground infrastructure like conduit can reduce disruption during future BRT construction.

DESIGN CONSIDERATIONS

A. Elements of BRT stations

Figure 3.5C.1 includes the typical elements of a BRT stop.

Figure 3.5C.1: Elements of Bus Rapid Transit stop



B. Accessible boarding area

At the front-door loading zone of every bus stop, an accessible boarding area must be provided for ADA access. It must have a clear length of 8' minimum, measured perpendicular to the curb or roadway edge, and a clear width of 5' minimum, measured parallel to the roadway.

C. Station location and design

1. Total width. Recommended width of a BRT station is 11'4", which includes the BRT shelter and curb-adjacent loading area. In constrained conditions where there are no other feasible options, a 9'4" station width can be considered.
2. Clear boarding area. A 6' minimum bus stop clear space boarding area adjacent to the curb should be included.
3. Shelter placement. Shelters can be placed in the frontage zone or boulevard and furniture zone, depending on demands in the corridor.
4. Shelter options. Standard BRT shelters are:
 - » Small: 5'4" x 11'9"
 - » Medium: 5'4" x 23'6"
 - » Large: 5'4" x 35'3"
 - » In constrained conditions where there are no other feasible options, a 3'4" x 11'9" shelter can be considered.
5. Curb height. BRT stations typically use a 9" curb to allow accessible bus boarding without deploying a ramp. A 9" curb may not be feasible in all locations. Grade transitions between BRT platforms and adjacent sidewalk zones must be designed to avoid tripping hazards and accommodate drainage needs. Designers should explore the feasibility of 9" curbs at a given location before BRT station locations are finalized.
6. Pedestrian access.
 - » Designers should work to maintain recommended pedestrian clear zone and frontage zone widths adjacent to shelters as outlined in the [sidewalk zone design guidance](#). A 6' or wider pedestrian clear zone is recommended for every street type. In constrained environments, narrower than 6' can be considered although every effort should be made to retain at least 5' pedestrian clear zone width. A minimum of 4' wide pedestrian clear zone must be maintained throughout to serve as the ADA-required pedestrian access route, although this should only be used in rare situations for short stretches in constrained right of way where every consideration has been taken to narrow all other street zones.
 - » A minimum of 6' of sidewalk width (frontage zone and pedestrian clear zone together) is required between a building and a vertical object like a transit station to meet ADA requirements, although this should only be used in rare constrained situations.
 - » Whenever possible, a straight pedestrian clear zone should be maintained adjacent to transit shelters.
 - » The bus stop clear space boarding area and the pedestrian clear zone can be combined and the shelter can be placed in the frontage zone along the edge of the street right of way (see Figure 3.5C.2).

Figure 3.5C.2: Constrained situation BRT station with smaller shelter and combined boarding area and pedestrian clear zone



Managing interactions between bus stops and bikeways can be complex, especially with bike lanes on constrained corridors.

INTRODUCTION

Managing interactions between bus stops and bikeways can be complex, especially with bike lanes on constrained corridors. There are two main options for managing this interaction:

- Floating bus stops, which are preferred for protected bike lanes; and
- Bus stop mixing zones, which are the default bus stop design for unprotected bike lanes and can be utilized for protected bike lanes in constrained situations.

Additional treatments for managing bus and bikeway interactions will be evaluated for consideration in future updates to the Street Design Guide.

FLOATING BUS STOPS

Floating bus stops are the preferred design for managing interactions between bus stops and protected bike lanes. Floating bus stops channelize the bike lane behind the bus stop to separate bicycle traffic and people boarding, alighting, or waiting for transit. Floating bus stops allow buses to stop in-lane while maintaining physical bike lane protection without the need for a mixing zone.

Floating bus stops require pedestrians to cross the bikeway operating area to access the bus stop. Bicycle traffic is expected to yield to pedestrians crossing the bikeway.

Figure 3.5D.1:

Floating bus stop graphic

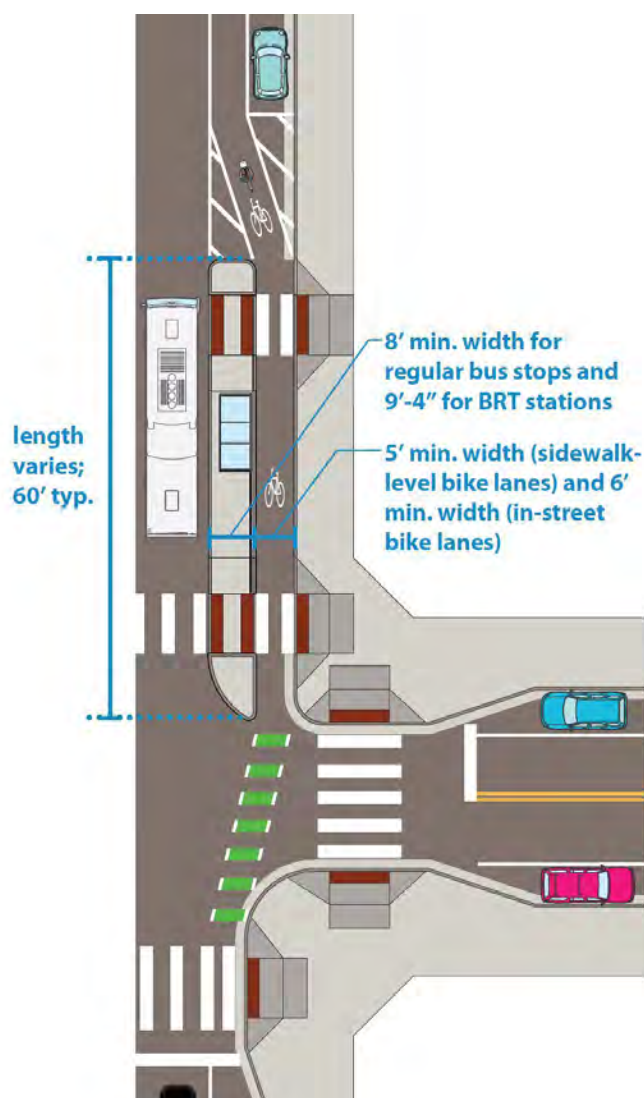

DESIGN CONSIDERATIONS

A. Design coordination	Floating bus stop design should be closely coordinated with Metro Transit.
B. Bus stop platform dimensions	<ol style="list-style-type: none"> 1. Floating bus stop platform dimensions should generally align with guidance for regular-route bus stops and Bus Rapid Transit stations. 2. The minimum width is 8' for regular-route bus stops and 9'4" for BRT stations. 3. Bus platform length varies, but is typically a minimum of 60'.
C. Bikeway clearance	2' clear zone is preferred from the bikeway to the floating bus stop and any vertical obstructions, though a 0' clear zone may be considered in space-constrained corridors.
D. Roadway clearance	Any vertical obstructions located on the floating transit stop must maintain 1.5' clearance from the roadway face-of-curb.
E. Curb height	Floating bus stops are typically sidewalk-level (6") for regular service bus stops, and at a 9" elevation for Bus Rapid Transit (BRT) Stations.
F. Bikeway width	See sidewalk-level protected bike lane guidance for recommended bikeway width. A minimum bike lane operating width of 6' must be maintained for maintenance operations.
G. Bikeway design speed	For State Aid streets, steep bike lane tapers to accommodate the floating transit stop will require a State Aid variance if design speeds are less than 20 mph.
H. Stormwater maintenance	Floating bus stops must accommodate access to and maintenance of all stormwater infrastructure. Floating bus stop design should be coordinated with Surface Water and Sewers.

I. Pedestrian and bike mixing zones

Employ pedestrian mixing zones where people biking must yield to pedestrians crossing the bike lane to access the floating bus stop. Design considerations for these mixing zones include:

1. For in-street bike lanes (retrofit projects):

- » Pedestrian crossings.
 - Considered raised pedestrian crossings across the bikeway to reinforce yielding to pedestrians.
 - Truncated domes and [curb ramps](#) (when there is a grade change) should be installed at all locations where pedestrians are expected to cross the bike lane operating area.
 - Consider crosswalk pavement markings at all locations where pedestrians are expected to cross the bike lane operating areas.
- » Bike lane differentiation. Consider using colored concrete to visually differentiate the bike lane operating space.
- » Slip-ramps. On-street bike lanes may employ slip ramps to raise up to sidewalk level adjacent to the floating transit stop.
- » Additional guidance. See [in-street curb-protected bike lane guidance](#) for additional details.

2. For sidewalk-level protected bike lanes (retrofit and full reconstruction projects):

- » Bike lane differentiation. Colored concrete or asphalt should be used to visually differentiate the bike lane operating space and standard concrete to delineate pedestrian mixing zones
- » Crosswalk markings. Consider crosswalk pavement markings at all locations where pedestrians are expected to cross the bike lane operating areas.
- » Detectable edge. A detectable edge (1' wide preferred; 0.5' minimum) should be implemented when sidewalk-level bike lanes are located directly adjacent to the pedestrian clear zone (see [sidewalk-level bike lane guidance](#) for addition details).
- » Sidewalk dimensions. See [sidewalk zone guidance](#) for recommended sidewalk widths by street type. 6' or wider pedestrian clear zones are recommended adjacent to sidewalk-level bike lanes. A minimum 4' pedestrian clear zone can be considered in rare, constrained situations where every consideration has been taken to narrow other street zones.
- » Additional guidance. See [sidewalk-level protected bike lane guidance](#) for additional details.

The roadway zone is typically located in the center of the right of way. This zone provides space for people driving and riding in motor vehicles, including transit.



INTRODUCTION

The roadway zone is typically located in the center of the right of way. This zone provides space for people driving and riding in motor vehicles, including transit. People riding bicycles and micromobility also share this space in most locations, and the bikeway zone may be in the roadway zone as well. The edges of this zone often provide space for motor vehicle parking, stopping buses, loading and unloading, or parklets and bicycle corrals. Gutters and catch basins are also included at the edge of the roadway zone; they provide critical space for conveyance of stormwater and are generally not considered functional travel space for vehicles.

The roadway may contain multiple marked or unmarked travel and parking lanes, including special use lanes like turn lanes or transit-only lanes. The roadway zone is used by all street users to cross intersecting streets and may be used exclusively by non-motorized users during events. Trails and some concepts for Urban Neighborhood streets do not include conventional roadway zones that maintain space for motor vehicles.

PRIORITIZING WALKING, BIKING, AND TRANSIT

Roadway design should ensure a people first future. The [Minneapolis Complete Streets policy](#) and [Transportation Action Plan](#) prioritize walking, biking, and transit over driving. Designers should plan for efficient and practical operations of people walking, biking and taking micromobility options, and transit throughout the street design process.

Minneapolis has a 2030 mode shift goal of getting to 35% of all trips walking, biking or micromobility, 25% transit (including school bus), and 20% each of multi-occupancy vehicle and driving alone. To get there we need to plan, design, and construct streets that provide more options for people to travel more efficiently and make it more convenient for people to make those choices.

The Transportation Action Plan includes the following actions that provide guidance for roadway design that support the mode share goal established in the plan:

Street Operations Action 3.1: Plan and design for zero or decreasing motor vehicle trip growth and positive growth in other modes for trip forecasting for street projects where the City is the primary implementer. Work with project partners to encourage this approach in project planning when the City is a partner versus a lead.

3.6A Roadways introduction

Street Operations Action 3.2: Discontinue the use of vehicular level of service except where necessary to meet funding, legislative or other jurisdictional requirements.

Street Operations Action 3.2: Discontinue the use of vehicular level of service except where necessary to meet funding, legislative or other jurisdictional requirements.

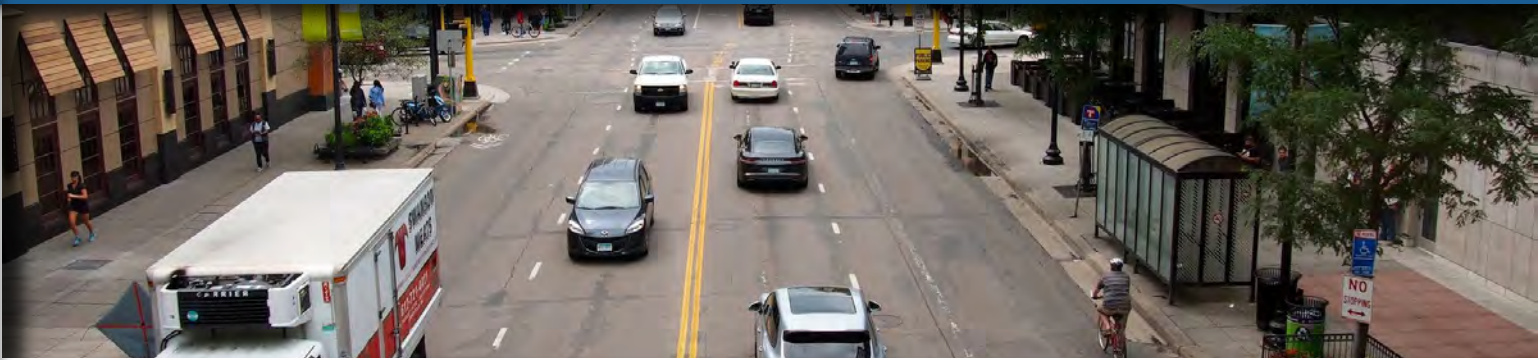

RECOMMENDED WIDTHS

Figure 3.6B.1:

Lane widths for all Street Types other than Urban Neighborhood

Roadway element	Recommended width
Travel lanes	10' ¹
Turn-only lanes	10' ²
Bus-only lanes	11' or 10' if adjacent to 2' gutter ³
Medians	6'+ ⁴
Gutter pans	2' ⁵ or 1' if adjacent to a median
Parking lane and other curbside uses	8' ⁶ (includes 2' gutter)
Bus stop pull out	8' ⁷ (includes 2' gutter)

1. For streets with high-frequency bus service or heavy semitruck volumes, one travel lane of 11' in each direction may be considered. Curb adjacent traffic lanes should not be wider than 10' given the adjacent gutter pan.
2. For turn lanes with heavy bus or heavy truck volumes, 11' may be considered.
3. For contraflow bus lanes, 11' lanes should be used even if adjacent to a 2' gutter.
4. 4' medians can be considered in constrained right of way.
5. For streets with constrained right of way, designers can consider 1' gutter pans or an integral 11' wide concrete lane. Flooding concerns may make narrower gutter pans infeasible; coordinate with Surface Water and Sewers.
6. 7' wide parking lanes should be considered in residential areas with constrained right of way. In some industrial areas, 9' wide parking lanes may be considered.
7. In constrained right of way, 7' wide bus stop pull outs may be considered.

Figure 3.6B.2:
Roadway widths for **Urban Neighborhood** streets

Configuration	Recommended width, including gutters
Street with parking on both sides	30' ⁸
Two-way street with parking on one side	24' ⁸
Two-way street with no parking	18'-20'
One-way street with parking on one side	18'-20'

8. For streets with higher than 75% average parking utilization, see design guidance for **Urban Neighborhood streets with high parking demand**.

Supporting safe traffic speeds is an essential aspect of Minneapolis Vision Zero work to eliminate traffic deaths and severe injuries.



INTRODUCTION

Supporting safe traffic speeds is an essential aspect of Minneapolis Vision Zero work to eliminate traffic deaths and severe injuries. Design speeds should align with a safe and reasonable target speed for the roadway context and use.

Design speeds should also ideally align with speed limits. Speed limits on City-owned streets were lowered in 2020 to support safety and the design speed on City streets aligns with those speed limits. Speed limits on County and MnDOT roads are often higher than the recommended design speeds shown in Figure 3.6C.1, which reflects the City's interest in seeing lower speed limits on many County and MnDOT roads.

Figure 3.6C.1:

Recommended typical design speeds by Street Types (MPH)

Street type	Typical design speeds
Urban Neighborhood	20
Urban Neighborhood Connector	25
Production and Processing	20 ¹
Mixed Use Community Connector	25
Mixed Use Commercial Connector	25
Mixed Use Regional Connector	30-40 ²
Downtown Core	25
Parkway	20-25 ³

1. Large trucks are frequent on Production and Processing streets and need to be considered when designing elements to support 20 mph speeds.
2. When there is pedestrian access or property access adjacent to the road, a maximum of 35 mph design speed should be used.
3. Parkways currently have 25 mph speed limits, but 20 mph design speeds may be appropriate for some parkways if the Park Board would like to lower the speed limit.

DESIGN SPEED CONSIDERATIONS

A. Recommended design speeds

1. Recommended design speeds in Figure 3.6C.1 only to apply to design factors that impact vehicle speed (e.g. horizontal curves). Design factors that do not directly impact vehicle speed (e.g. stormwater spread calculations and street lighting calculations) do not need to be updated.

2. In some cases, a different design speed than the typical may be appropriate.

- » Design speeds on individual streets should generally match the planned speed limit after construction.
- » Lower design speeds and posted speed limits may be considered for Urban Neighborhood streets with neighborhood greenways.

B. State Aid rules

The [State Aid rules](#) allow 25 mph design speed for streets with a bikeway and less than 10,000 average daily traffic, but require 30 mph design speed for other streets. Designers should strongly consider applying for a variance for design speed if it will have a meaningful impact on traffic calming and safety; a variance application may or may not be accepted



Designing streets to support safe and reasonable target speeds is critical for Minneapolis Vision Zero work to eliminate traffic deaths and severe injuries.

INTRODUCTION

Designing streets to support safe and reasonable target speeds is critical for Minneapolis Vision Zero work to eliminate traffic deaths and severe injuries. See [design speed guidance](#) for more details on recommended design speeds.

Minneapolis Public Works is in the process of updating traffic calming procedures. Updated neighborhood traffic calming procedures will be added later in the future. [NACTO guidance on speed reduction mechanisms is available here.](#)

NEIGHBORHOOD TRAFFIC CALMING

Updated neighborhood traffic calming procedures will be added in the future.

CHICANES

Chicanes are a traffic calming technique that can be considered for Urban Neighborhood or Urban Neighborhood Connector streets. Additional guidance will be added in the future. [NACTO guidance is available here.](#)

Bus-only lanes provide dedicated space for buses to improve the speed and reliability of transit service.



INTRODUCTION

Bus-only lanes provide dedicated space for buses to improve the speed and reliability of transit service. They may be implemented for a select period of time or throughout the entire day depending on context. They can be implemented as part of street reconstruction or street retrofit projects. The Transportation Action Plan includes [specific locations](#) for implementation and evaluation for bus-only lanes. Other corridors may be considered on a case-by-case basis.

DESIGN CONSIDERATIONS

See also [transit stops guidance](#).

A. Location	Bus-only lanes can be implemented along the curb, in through lanes that are not curbside, or be center running.
B. Width	Curbside bus-only lanes should typically be 10' wide in addition to an adjacent 2' gutter. Non-curbside bus-only lanes should typically be 11' wide.
C. Coordination with other transit advantages	Bus-only lanes should typically be implemented in combination with other transit advantages along a corridor, such as transit signal priority and queue jumps.
D. Color	Bus-only lanes can be painted red to provide additional visibility and clarity for drivers.

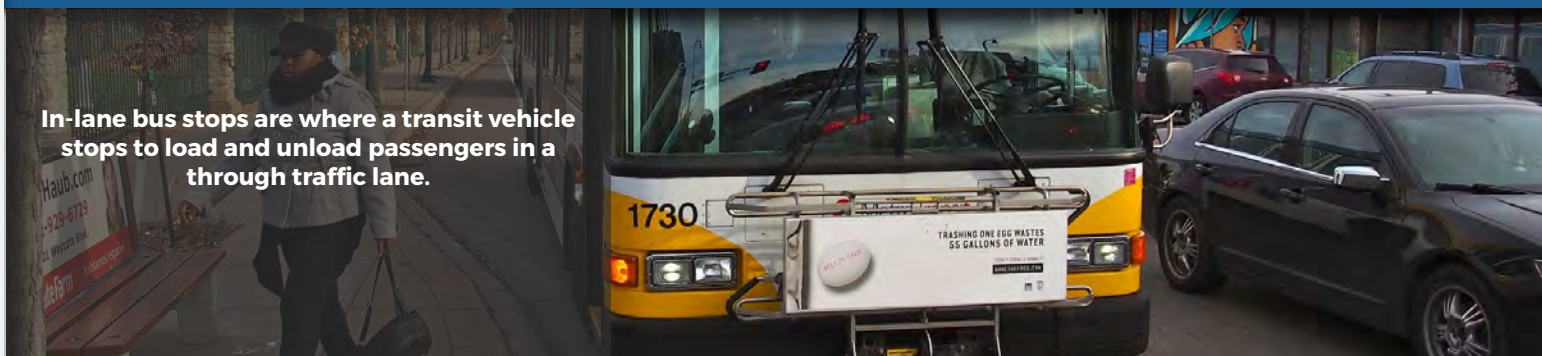

In-lane bus stops are where a transit vehicle stops to load and unload passengers in a through traffic lane.

INTRODUCTION

In-lane bus stops are where a transit vehicle stops to load and unload passengers in a through traffic lane. In-lane bus stops are preferred for bus rapid transit routes because they do not require the bus to merge back into traffic after making the stop, which is faster. They also can be beneficial for regular-route transit stops as they expand the available space for transit stop and sidewalk zone uses and allow for tighter, safer intersections. On streets with a single traffic lane in a direction, designers should work to mitigate the safety concerns of drivers passing a stopped bus.

Designers should discuss with Metro Transit and Traffic and Parking Services when determining if an in-lane bus stop is appropriate in an individual context. These factors should be considered:

- **Traffic volumes**, including annual daily traffic, peak hour traffic, directionality, and turning movements;
- **Transit service**, including frequency, directionality, stop spacing, stop consolidation, ridership volumes, whether there is off-board fare collection, and bus size; and
- **Context**, including number of traffic lanes, driveway access, loading zones, intersection control (stop, signal, RRFB), and cross-street modal networks.

DESIGN CONSIDERATIONS

See also [transit stop guidance](#). Designers should coordinate with Metro Transit.

A. Lane widths

The lane where the bus stops should generally be the same width as the traffic lane leading up to the bus stop to discourage vehicles trying to pass the bus in the same lane.

B. Curb extensions

If there is parking, [curb extensions](#) should be implemented with bus stop to align with the bus doors.

C. Hardened centerlines and medians when stopping in sole traffic lane

A hardened centerline or a median should be considered at an in-lane bus stop when a bus will be stopping in the sole traffic lane in a given direction. The hardened centerline or median is provided to reduce the likelihood that drivers will pass the bus.

1. The hardened centerline should be 1' wide (see Figure 3.6F.1).
2. The median should be 4' or wider when feasible to support a [pedestrian safety island](#) (see Figure 3.6F.2).
3. The hardened centerline or median should generally be 20' longer than the longest bus that will use the stop.
4. Generally use 1:3 tapers; if a lane shift is involved, the taper needs to be evaluated further.
5. The detailed design for hardened centerlines and medians adjacent to in-lane bus stops is being constructed on several upcoming projects in Minneapolis and will be evaluated to inform how they may evolve.

Figure 3.6F.1:

Hardened centerline at in-lane bus stop

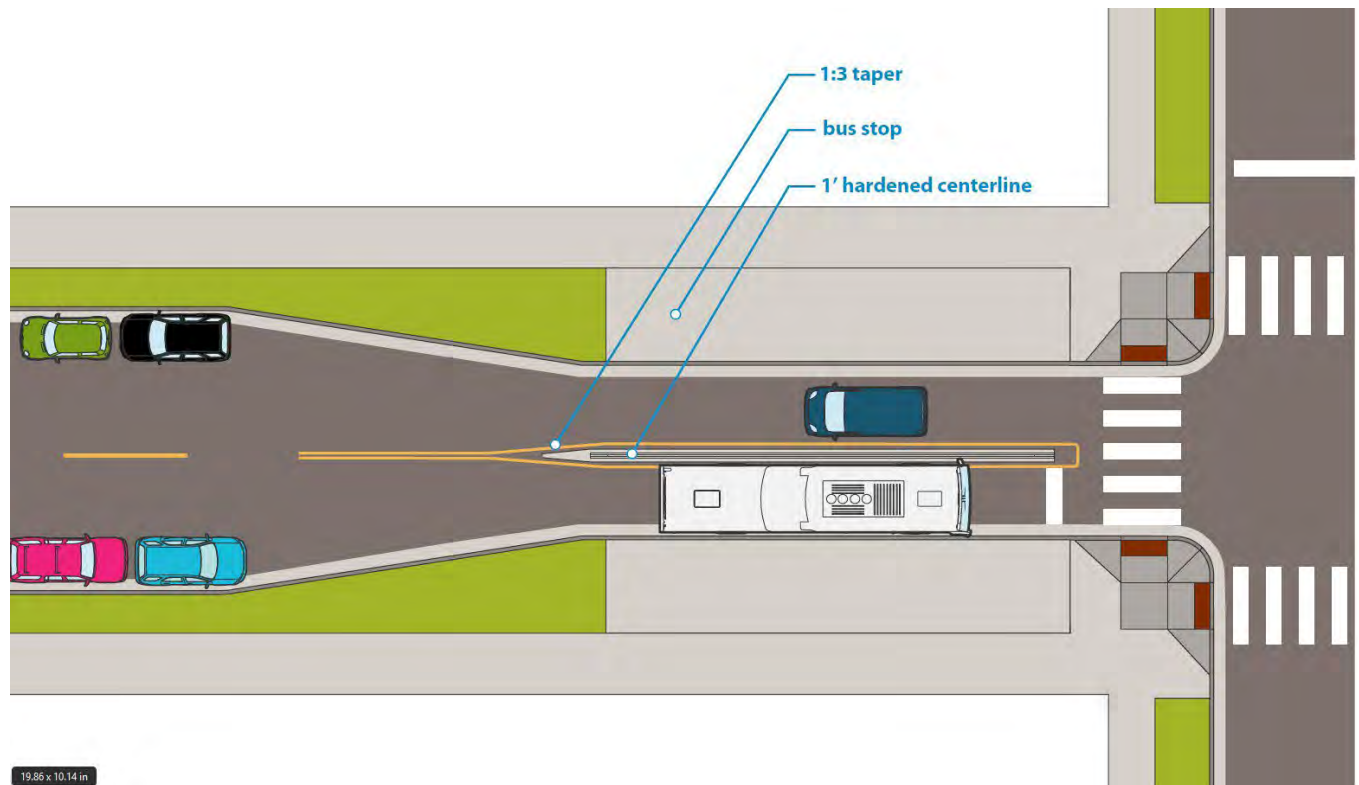

3.6F In-lane bus stops

Figure 3.6F.2:
Median at in-lane bus stop

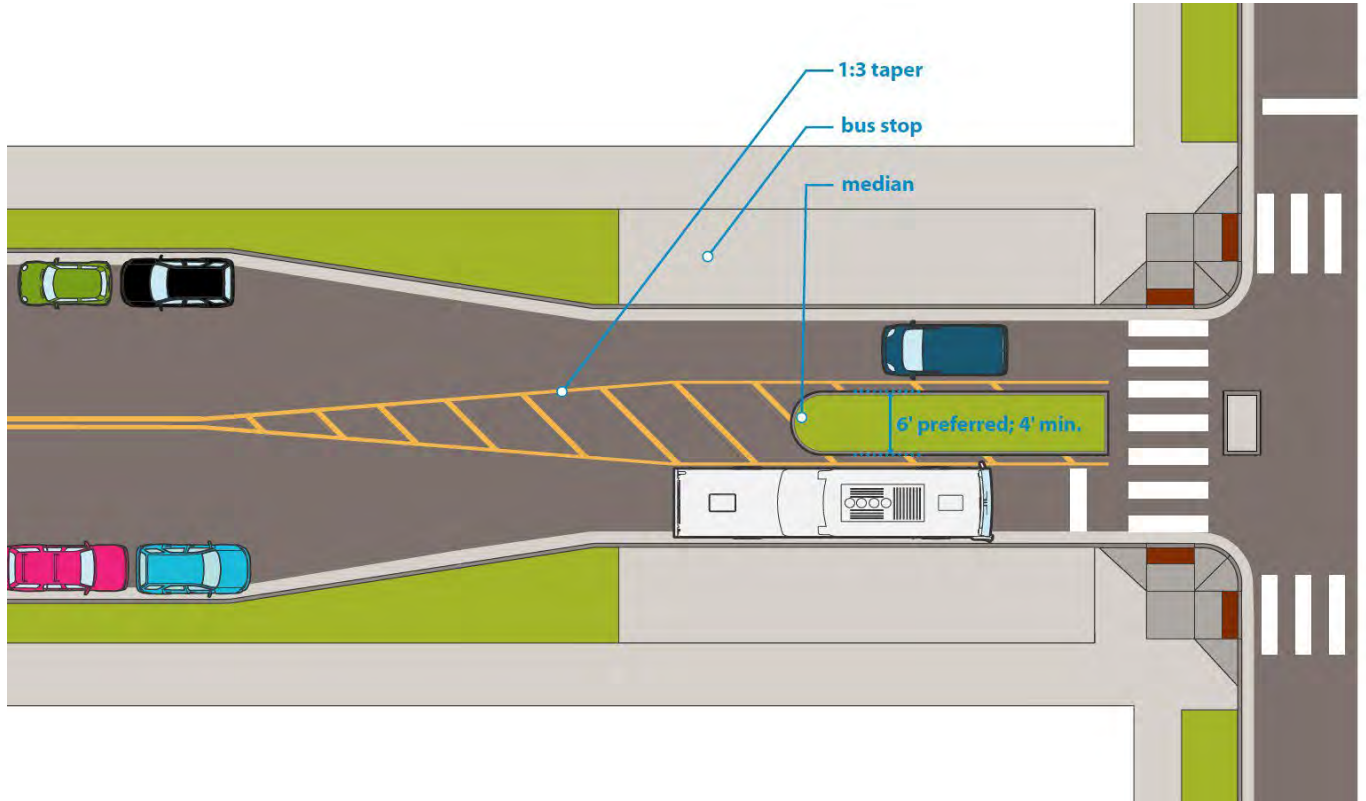

The curbside area of the roadway zone is often used for vehicle parking, loading and unloading zones, drop-off zones, bicycle corrals, mobility hubs, parklets, street cafes, and/or expanded greening.

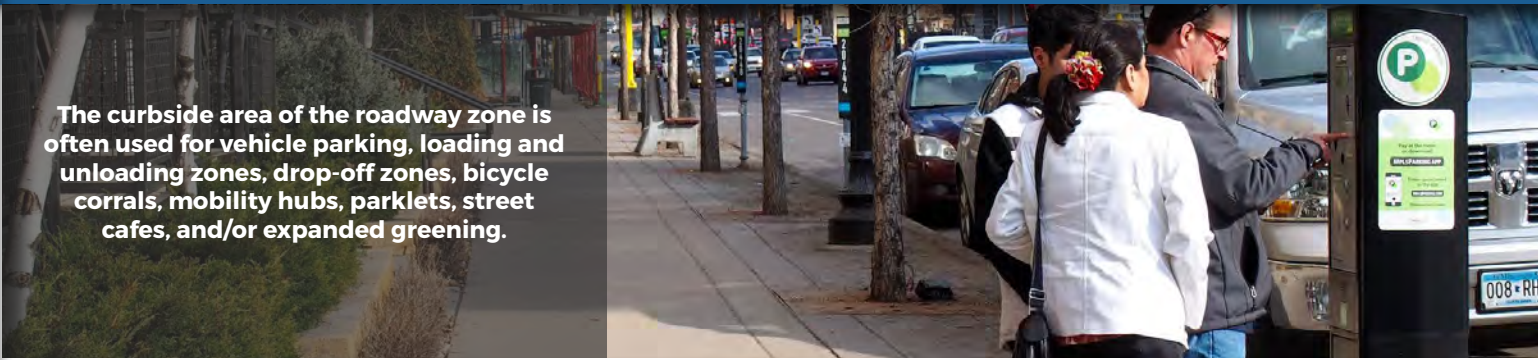

INTRODUCTION

The curbside area of the roadway zone is often used for vehicle parking, loading and unloading zones, drop-off zones, bicycle corrals, mobility hubs, parklets, street cafes, and/or expanded greening.

The Transportation Action Plan includes [Street Operations strategy 5](#): “Price and manage use of the curb to encourage walking, biking and using transit and to discourage driving alone.” Public Works is creating a curbside management policy; this section will be updated to reflect that policy when adopted.

DESIGN CONSIDERATIONS

A. Width	<ol style="list-style-type: none"> 1. Parking lane and curbside use areas should typically be 8' wide. 2. 7' wide parking lanes should be considered in residential areas with constrained right of way. 3. In some industrial areas, 9' wide parking lanes may be considered.
B. Inclusion of vehicle parking	<ol style="list-style-type: none"> 1. The amount of vehicle parking should be right sized to reduce speeding and maximize space for greening and other uses that support City goals. Streets may include no on-street parking, parking on one side, parking on both sides, or a combination of parking availability. 2. For Urban Neighborhood, Urban Neighborhood Connector, and Production and Processing streets, target greater than 60% parking occupancy. 3. For Mixed Use Community Connectors, target greater than 75% parking occupancy.
C. Streets with parking on one side	<p>If there will generally be parking on one-side of the street, it's preferred that it shift back and forth from either side of the street to provide parking access on both sides and support traffic calming.</p>
D. Loading and unloading zones for streets without parking	<ol style="list-style-type: none"> 1. For streets without any vehicle parking, consider including one or more loading and unloading zones to support deliveries, Metro Mobility drop offs, and other short-term uses. 2. Such a zone differs from existing commercial loading zones and will need to be considered on a case-by-case basis. 3. Loading and unloading zones should generally be 7'-8' wide and 25'-30' long. Metro Mobility vehicles typically range from 20'-25' long and should be accommodated.

E. Disability parking zones	Property owners may request disability parking zones , which are not exclusive to any resident or property owner. On projects that may impact a disability parking zone, designers should determine whether the zone is still actively used and work with the applicant to provide reasonable accommodation for it or relocate if it is still active.
F. Parking meters	In commercial areas and some other high-parking demand areas, designers should strongly consider adding parking meters to regulate parking.
G. Critical Parking Areas	Critical Parking Areas limit parking access to drivers with a permit associated with that specific area. Designers should consider impacts to Critical Parking Areas with any parking changes.
H. Commercial loading zones	Commercial loading zones are spaces limited to loading and unloading of registered commercial vehicles during certain hours. Designers should consider impacts to commercial loading zones with any parking changes.
I. Curb extensions at intersections	<p>Curb extensions should generally be included at all intersections whenever on-street parking is provided. Exceptions include:</p> <ol style="list-style-type: none"> 1. For intersecting Urban Neighborhood streets, a traffic circle may be preferred to curb extensions. 2. On Production and Processing streets, curb extensions may not be feasible given the frequency of large trucks. 3. In some situations, a turn lane or bus pull-out area may be preferred to curb extensions.
J. Midblock curb extensions	<ol style="list-style-type: none"> 1. Designers can consider midblock curb extensions into the curbside zone to provide expanded space for greening, street trees, green stormwater infrastructure, sidewalk cafes, or other sidewalk zone uses. 2. Unless specifically designed to support a pedestrian crossing, midblock curb extensions should be clearly designed not to encourage pedestrian crossing (e.g. with the placement of street trees and green stormwater infrastructure).
K. Mobility hubs	Mobility hubs are physical places where people can connect to multiple modes of transportation to make their trip as safe, convenient and reliable as possible. Mobility hubs are typically in the curbside area. Mobility hub details vary by location. See Transportation Action Plan Technology strategy 3 for more details.
L. Parklets	Parklets are designed as an extension of the sidewalk where the public can relax and enjoy the urban environment. They are installed in the space adjacent to the curb. The City manages a parklet program .
M. Street cafes	A street café is a seasonal expansion of the existing sidewalk to be used for additional restaurant or business seating. More information on the City's street café program is available here .
N. Bicycle corrals	Bicycle and micromobility parking can be provided in the roadway adjacent to the curb. See bicycle parking guidance for more details.

3.6H Medians

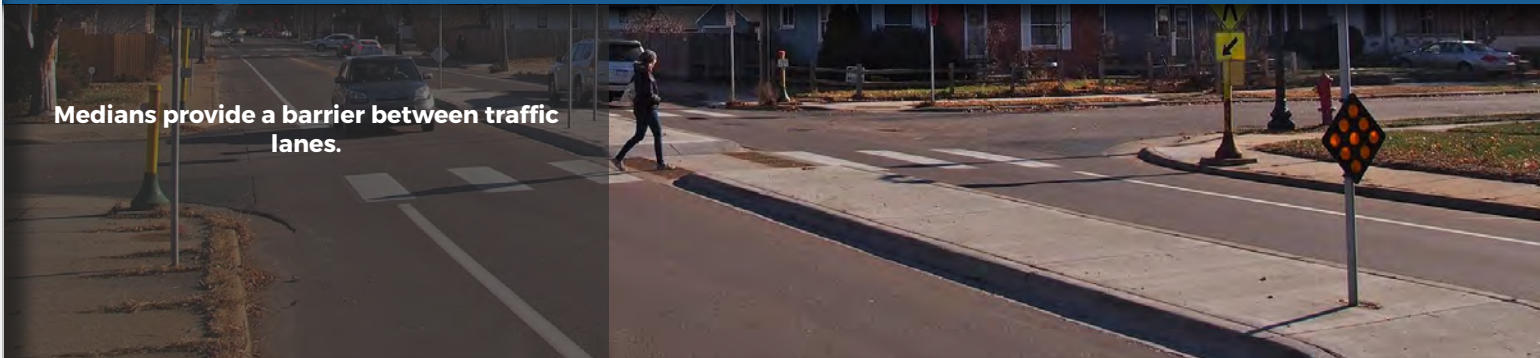

INTRODUCTION

Medians provide a barrier between traffic lanes. They can be used to provide refuge for people walking and biking, to protect against head-on motor vehicle crashes, to prevent turns, and to provide space for greening. Medians can be installed as part of street reconstruction or retrofit projects.

Figure 3.6H.1:

Medians recommended dimensions

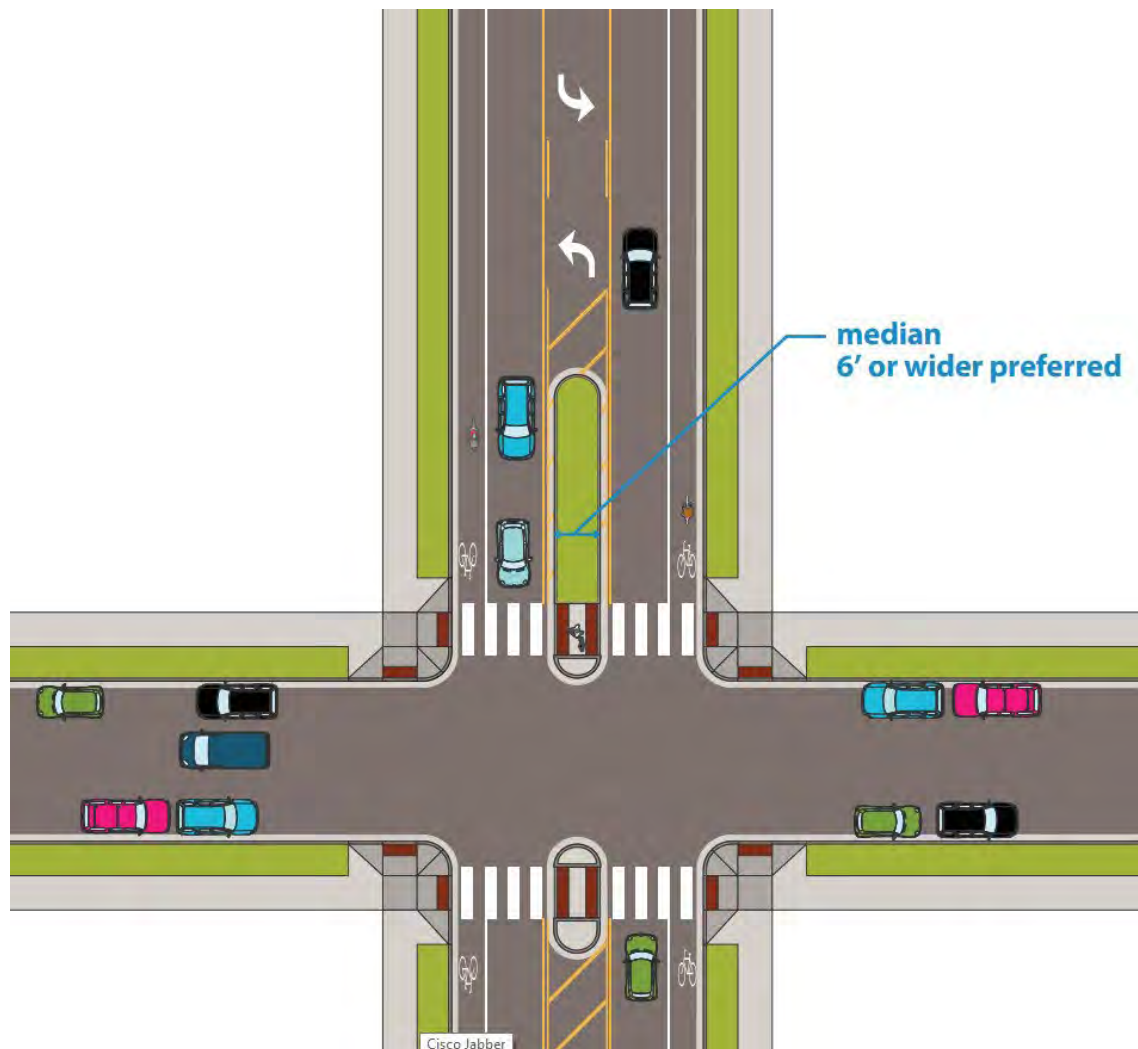

DESIGN CONSIDERATIONS

A. Preferred width	<ol style="list-style-type: none"> 1. Medians of 6' and wider are preferred because they provide an accessible pedestrian refuge space and additional space for greening. 2. Consider widths greater than 8' along major bike crossings to provide adequate refuge space for bikes. 3. 4' medians can be considered in constrained right of way. <p>See also bicycle safety islands.</p>
B. Greening	<ol style="list-style-type: none"> 1. Designers should generally work to include greening in medians whenever feasible. 2. Plantings need to be shorter than 3' tall to maintain visibility. 3. Maintenance of greening needs to be coordinated ahead of time. 4. There are unique considerations for placing green stormwater infrastructure in a median, including details on inlets and maintenance access. Coordinate with Surface Water and Sewers. 5. See greening guidance and green stormwater infrastructure guidance for more details.
C. Curb and gutter	<p>Standard 6" curb tops and 1' gutters are generally used adjacent to medians. If there are catch basins adjacent to medians, 2' gutters should typically be used.</p>
D. Delineator medians	<p>Low-cost medians can be implemented using delineators in street retrofit projects.</p>

Historic streets are specifically identified streets that may still retain some level of historic character or original historic brick paving, cobble paving, or granite curbs.

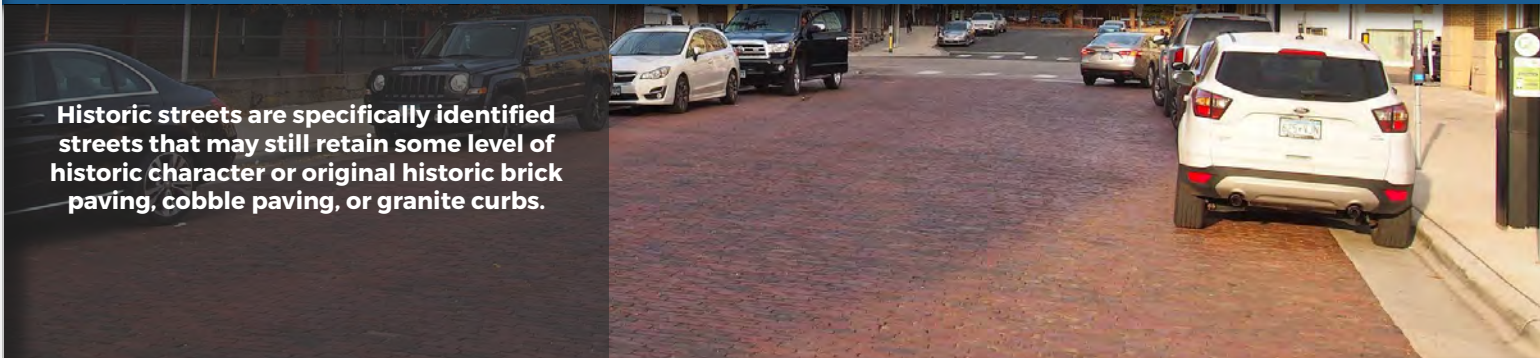

INTRODUCTION

Historic streets are specifically identified streets that may still retain some level of historic character or original historic brick paving, cobble paving, or granite curbs. They may also include streets that have been reconstructed with salvaged original or modern pavers to reflect a historic character. Historic streets are identified in a layer in the [Street Types map](#) and listed below as either identified for preservation or identified for historic infrastructure salvage.

Historic streets identified for preservation include:

- Traffic Street (3rd Ave. N. to Dock St.)
- 3rd St. N (10th Ave. N. to 7th Ave N.)
- 2nd Ave. N. (1st St. N. to the Federal Reserve)
- 6th Ave. N. (Washington Ave. N. to 5th St. N.)
- 8th Ave. N. (Washington Ave. N. to 3rd St. N.)
- 9th Ave. N. (Washington Ave. N. to 3rd St. N.)
- Main St. S.E. (Hennepin Ave. to 6th Ave. S.E.)
- 6th Ave. S.E. (Main St. S.E. to the Stone Arch Bridge Cul-de-Sac)
- Island Ave. (East & West), Grove St, Maple Place, and Nicollet St. on the north end of Nicollet Island.
- Main St. S.E. (Hennepin Ave. to 6th Ave. S.E.)
- 6th Ave. S.E. (Main St. S.E. to the Stone Arch Bridge Cul-de-Sac)

Streets identified for historic infrastructure salvage include:

- 5th Ave. N. (Washington Ave. N. to 5th St. N.)
- 7th Ave. N. (Washington Ave. N. to 4th St. N.)
- 3rd St. N. (7th Ave N. to 5th Ave. N.)
- Quincy St. N.E. (Broadway St. N.E. to 15th Ave. N.E.)
- 14th Ave. N. E. (Quincy St. N.E. to 154' east of the BNRR)
- Jackson St. N.E. (Broadway St. N.E. to 12th Ave. N.E.)
- 12th Ave. N.E. (Johnson St. N.E. to Central Ave. N.E.)

DESIGN CONSIDERATIONS

A. General	<p>Historic streets should be designed using the appropriate guidance for the given street found in the Street Type Guidance chapter – even if that means adjustments to the historic design of the street.</p> <p>Historic streets should be reconstructed, maintained, and repaired in accordance with all applicable City Ordinances and Standard Specifications and Detail Plates.</p> <ol style="list-style-type: none"> 1. All historic streets will continue to follow uniform assessment procedures as already established by the City.
B. Accessibility	<p>All streets must conform to ADA accessibility regulations and guidance.</p> <ol style="list-style-type: none"> 1. Crosswalks on historic streets should generally be paved with concrete or asphalt to support accessible street crossings.
C. Historic coordination	<p>Coordination with the Heritage Preservation Commission or State Historic Preservation Office will be needed during the planning and design process for historic streets located in local or national historic districts.</p>
D. Sidewalks widths	<p>Historic streets with loading docks create the potential for pedestrian and vehicle conflicts.</p> <p>The minimum acceptable width for the sidewalk zone around loading docks should align with appropriate sidewalk zone guidance unless the specific conditions of a particular historic street make that not feasible.</p> <ol style="list-style-type: none"> 1. Pedestrian space around loading docks must adhere to ADA design standards and will need to be clearly delineated from automobile space.
E. Street Trees	<ol style="list-style-type: none"> 1. The addition of street trees should be strongly considered on all historic streets. 2. Street trees that are planted on historic streets should be placed to maintain visual access to the front of historically significant buildings. <p>See street trees guidance for more details.</p>

USE OF HISTORIC MATERIALS

The preservation and retention of historic materials is also important to maintaining the historic character of Minneapolis. When possible, historic brick pavers should be removed, cleaned, and reinstalled where feasible on a historic street. When possible, stone curbs should be preserved in place, reinstalled as part of a street reconstruction project or salvaged and stored as applicable for future use. Note that this does not apply to streets that were paved with modern paving materials (i.e. Island Ave. on Nicollet Island).

The historic infrastructure or character of a historic street should be preserved and maintained when possible. Historic streets identified for preservation (listed above) retain a significant portion of the original historic infrastructure in relatively undisturbed condition or have been recently reconstructed utilizing historic pavement materials or compatible substitute materials to maintain and preserve the historic character of the street.

Historic pavement materials (pavers, bricks, and cobblestones) are limited resources. Replacement of historic street paving materials should be considered if Public Works determines that historic materials are too deteriorated or costly to repair.

To restore and maintain the historic character of existing historic streets that may be too deteriorated or costly to fully preserve, the following options should be explored if a shortage of historic materials exists:

1. Salvage pavers from historic streets that are identified for historic infrastructure salvage (listed above) or from City street reconstruction projects that uncover these materials. The City should preserve and salvage historic pavement materials as a source of materials for the long-term maintenance and repair of streets designated for preservation. Streets identified for salvage are those streets that retain a portion of the original historic infrastructure but have undergone significant deterioration and disturbance.
2. Modify the design of a specific historic street project (i.e. placing historic pavers only in the driving lanes and placing concrete in the designated parking lanes).
3. Purchase similar historic pavers from paver suppliers.
4. Verify if other sources of bricks exist to augment the historic paver quantities.
5. Consider compatible substitute materials that will maintain the character of a historic street if using historic materials are deemed not technically or economically feasible by Public Works. (i.e. Island Ave. on Nicollet Island and Main St. S.E. from Hennepin Ave. to 6th Ave. N. were recently paved with compatible, modern paving materials that retain the historic character of those streets).

If other projects on Minneapolis streets uncover or disturb historic pavers, any entity (including all City Departments, other Government Agencies, Utility Companies, Developers, Contractors, and Property Owners) causing a disturbance to the surface of a street containing historic pavement materials should repair or replace those historic materials per guidelines established in [Chapter 430 of the Minneapolis Code of Ordinances](#).

Intersections are critical to streets that are safe, efficient, and attractive for people walking, biking, using transit, and driving.

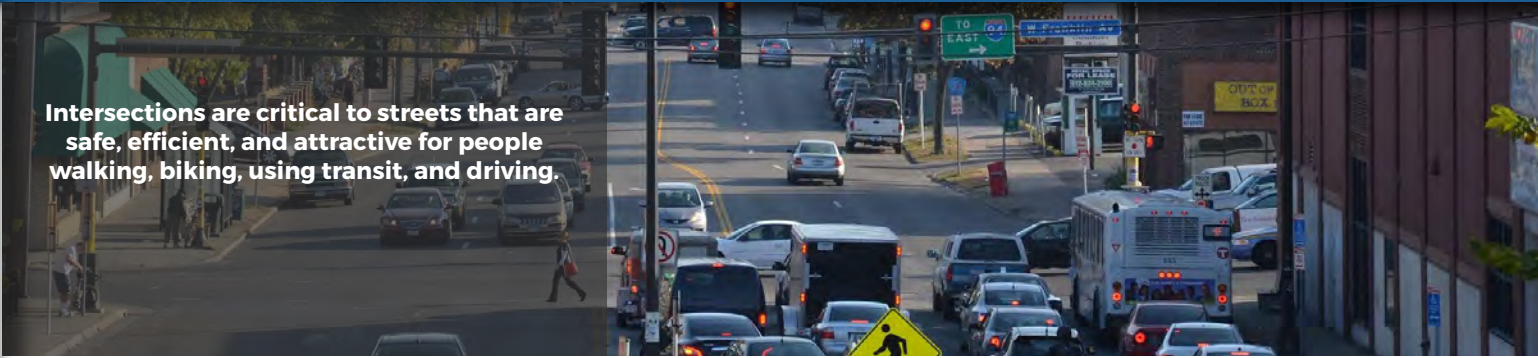

INTERSECTIONS INTRODUCTION AND GENERAL GUIDANCE

Intersections are critical to streets that are safe, efficient, and attractive for people walking, biking, using transit, and driving. The most serious conflicts between modes happen at intersections and more than 80% of crashes in Minneapolis happen at intersections.

Intersection design should support visibility and predictability for all modes and should prioritize people walking, biking, and transit per the Minneapolis Complete Streets policy. Intersections should be designed to:

- Be as compact as possible to reduce exposure for pedestrians and bicyclists and to slow turning traffic;
- Provide clear space for each mode and predictable conflict points that are well managed;
- Be accessible for people with disabilities; and
- Minimize obstructions that limit visibility and provide good street lighting.



Intersection design must prioritize safety for the most vulnerable users of the roadway while accommodating safe movement for the appropriate mix of motorized vehicle types.

INTRODUCTION

Intersection design must prioritize safety for the most vulnerable users of the roadway while accommodating safe movement for the appropriate mix of motorized vehicle types. This balance is achieved through utilizing the following design principles:

- Incorporating the smallest practical curb-return radius to reduce driver turning speeds while still accommodating ADA-compliant pedestrian facilities;
- Reducing the intersection crossing distance as much as possible for people walking and biking while improving sightlines for drivers; and
- Design intersections for the appropriate mix of motorized traffic by selecting the appropriate design and control vehicles.

In the design process, the design and control vehicles are important determinants for curb-return radii. Selection of an appropriately sized vehicle is a critical aspect of achieving streets that prioritize safety for the most vulnerable users of the roadway. When a street is designed to accommodate design and control vehicles larger than typically necessary, the safety of people walking, biking, and driving is negatively impacted by intersections that promote higher turning speeds and longer crossing distances. Selecting design and control vehicles smaller than appropriate also compromises the safety of people biking and walking, as large vehicles may be required to frequently mount the curb to complete a turn.

DESIGN VEHICLE

The design vehicle is the least maneuverable vehicle expected to regularly use the intersection; it informs what vehicular operations need to be accommodated regularly in the geometric design of the intersection. Design vehicles should typically be accommodated without encroachment into opposing traffic lanes.

The smallest appropriate design vehicle should be selected based upon the street type and adjacent land use context. Depending on the street typology, Minneapolis uses the following typical design vehicles: DL-23, SU-30, and WB-40. See Figure 3.7B.1 and Figure 3.7B.2.

3.7B Design and control vehicles

Figure 3.7B.1:
Design Vehicle Examples

Engineering & Common Name	Design Vehicle Number	Dimensioned by	Width (ft)	Length (ft)	Effective Wheelbase (ft)	Image
Delivery Truck I.E. Cargo Van	DL-23	NACTO	8.5	22.6	16	
Single-Unit Truck I.E. Moving Truck	SU-30	AASHTO, NACTO	8	30	20	
Intermediate Semitrailer	WB-40	AASHTO	8	45.5	25.5	

Figure 3.7B.2:
Typical Design Vehicles by Intersecting Street Type

	Street Type	Urban Neighborhood	Urban Neighborhood Connector	Parkway	Production and Processing	Mixed Use Community Connector	Mixed Use Commercial Connector	Mixed Use Regional Connector	Downtown Core	Truck Route
Design Vehicle	Urban Neighborhood	DL-23	DL-23	DL-23	WB-40	SU-30	SU-30	WB-40	SU-30	SU-30
	Urban Neighborhood Connector	DL-23	DL-23	DL-23	WB-40	SU-30	SU-30	WB-40	SU-30	SU-30
	Parkway	DL-23	DL-23	DL-23	WB-40	SU-30	SU-30	WB-40	SU-30	SU-30
	Production and Processing	WB-40	WB-40	WB-40	WB-40	WB-40	WB-40	WB-40	WB-40	WB-40
	Mixed Use Community Connector	SU-30	SU-30	SU-30	WB-40	SU-30	SU-30	WB-40	SU-30	WB-40
	Mixed Use Commercial Connector	SU-30	SU-30	SU-30	WB-40	SU-30	SU-30	WB-40	SU-30	WB-40
	Mixed Use Regional Connector	SU-30	SU-30	SU-30	WB-40	SU-30	SU-30	WB-40	SU-30	WB-40
	Downtown Core	SU-30	SU-30	SU-30	WB-40	SU-30	SU-30	WB-40	SU-30	WB-40
	Truck Route	SU-30	SU-30	SU-30	WB-40	WB-40	WB-40	WB-40	WB-40	WB-40

Exceptions

Using different design vehicles than prescribed in Figure 3.7B.2 may be pursued in the following circumstances:

- When there is a demonstrated need to routinely accommodate turning design vehicles larger than prescribed in Figure 3.7B.2 (e.g. a city bus, WB-40, or WB-50)).
 - » Project managers must demonstrate the need to accommodate design vehicles larger than prescribed in Figure 3.7B.2 through the following process:

- Collect traffic data to determine the mix of heavy vehicle traffic;
 - Work with property owners to identify specific vehicles, confirm access points, and delivery times and frequencies; and
 - Determine if existing and future needs necessitate accommodating a larger design vehicle.
2. At intersections with bus routes where transit buses are routinely required to make a turn, an appropriately sized bus may be used as the design vehicle.
- » Project managers must accommodate necessary turning movements for transit service and should anticipate any future routing revisions during the design process.
 - » Along bus routes where buses are not required to turn, design vehicles smaller than a bus may be used.

CONTROL VEHICLE

The control vehicle is an infrequent but necessary user of the street and informs what vehicular operations need to be accommodated somehow in the design of the street. Current Traffic and Parking Services policy allows control vehicles to encroach into approximately 1/3rd of adjacent or opposing travel lanes or into the gutter pan. Infrequent vehicles larger than the control vehicle can still navigate the intersection, but would need to encroach beyond 1/3rd of adjacent or opposing travel lane and/or track over the curb to make the turn.

- See Figure 3.7B.3 for control vehicle examples and Figure 3.7B.4 for typical control vehicles by intersecting street type.
- Emergency vehicles always need to be accommodated, regardless of street type. Therefore, a fire truck (Aerial Fire Truck MM 100) is the identified Minneapolis control vehicle for most street types with low volumes of heavy vehicle traffic. The Aerial Fire Truck will accommodate turning movements for all vehicles including and smaller than a WB-40. Project managers should continue to work with the Minneapolis Fire Department to understand evolving vehicle designs and operations.
- For truck routes, Production and Processing streets, and Mixed Use Regional Connectors where higher volumes of heavy vehicle traffic is expected, a WB-62 semi-trailer truck should typically be used as the control vehicle.

Figure 3.7B.3:

Control Vehicle Examples

Engineering & Common Name	Design Vehicle Number	Dimensioned by	Width (ft)	Length (ft)	Effective Wheelbase (ft)	Image
Small-Platform Emergency Vehicle I.E. Fire	MM-100	NCHRP	8	48.2	20.8	
Truck Interstate Semitrailer	WB-62	AASHTO	8.5	69	41	

Figure 3.7B.4:

Typical Control Vehicles by Intersecting Street Type

	Street Type	Urban Neighborhood	Urban Neighborhood Connector	Parkway	Production and Processing	Mixed Use Community Connector	Mixed Use Commercial Connector	Mixed Use Regional Connector	Downtown Core	Truck Route
Control Vehicle	Urban Neighborhood	FIRE ¹	FIRE ¹	FIRE ¹	FIRE ¹	FIRE ¹	FIRE ¹	FIRE ¹	FIRE ¹	FIRE ¹
	Urban Neighborhood Connector	FIRE ¹	FIRE ¹	FIRE ¹	FIRE ¹	FIRE ¹	FIRE ¹	FIRE ¹	FIRE ¹	FIRE ¹
	Parkway	FIRE ¹	FIRE ¹	FIRE ¹	FIRE ¹	FIRE ¹	FIRE ¹	FIRE ¹	FIRE ¹	FIRE ¹
	Production and Processing	FIRE ¹	FIRE ¹	FIRE ¹	WB-62 ²	WB-62 ²	WB-62 ²	WB-62 ²	WB-62 ²	WB-62 ²
	Mixed Use Community Connector	FIRE ¹	FIRE ¹	FIRE ¹	FIRE ¹	FIRE ¹	FIRE ¹	FIRE ¹	FIRE ¹	FIRE ¹
	Mixed Use Commercial Connector	FIRE ¹	FIRE ¹	FIRE ¹	WB-62 ²	FIRE ¹	FIRE ¹	FIRE ¹	FIRE ¹	WB-62 ²
	Mixed Use Regional Connector	FIRE ¹	FIRE ¹	FIRE ¹	WB-62 ²	FIRE ¹	FIRE ¹	WB-62 ²	WB-62 ²	WB-62 ²
	Downtown Core	FIRE ¹	FIRE ¹	FIRE ¹	WB-62 ²	FIRE ¹	FIRE ¹	WB-62 ²	FIRE ¹	WB-62 ²
Truck Route	FIRE ¹	FIRE ¹	FIRE ¹	WB-62 ²	FIRE ¹	WB-62 ²	WB-62 ²	WB-62 ²	WB-62 ²	

1. FIRE assumes an "Aerial Fire Truck Mid Mount (MM) 100." An Aerial Fire MM 100 will accommodate turning movements for all vehicles including and smaller than a WB-40.
2. Project managers should confirm whether WB-62 turning movements need to be accommodated at all intersections during the design process.

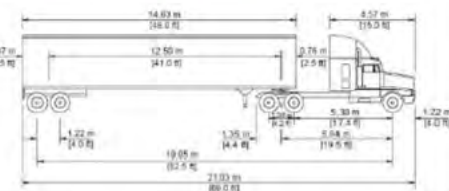
Exceptions

Using different control vehicles than prescribed in Figure 3.7B.4 may be pursued in the following circumstances:

1. On intersecting streets where WB-62 is identified as the typical control vehicle, a smaller vehicle should be used where WB-62 turning movements are not anticipated or expected in the future.
2. When there is a demonstrated need to routinely accommodate turning control vehicles larger than prescribed in Figure 3.7B.4 (e.g. a WB-50, WB-62, and on rare occasions a WB-67). Project managers must demonstrate the need to accommodate control vehicles larger than prescribed in Figure 3.7B.4 through the following process:
 - » Collect traffic data to determine the mix of heavy vehicle traffic;
 - » Work with property owners to identify specific vehicles, confirm access points, and delivery times and frequencies; and
 - » Determine if existing and future needs necessitate accommodating a larger control vehicle.

Considerations for County and MnDOT Roads

1. County and MnDOT Roads. City staff should encourage design and control vehicles in line with the guidance in this section when coordinating with Hennepin County and MnDOT staff on intersections with County and MnDOT roads.
2. Hennepin County. When determining design and control vehicles, Hennepin County considers the context of the intersection, the mix of vehicles making turns, and coordinates with the local jurisdiction.
 - » For design vehicle, County staff frequently use the WB-50.
 - » For control vehicles, County staff typically uses a WB-62 on CSAH (County State Aid Highway) to CSAH routes, and a WB-50 on CSAH to MSA (Municipal State Aid) routes.

3. MnDOT. The MnDOT Road Design Manual calls for the largest frequent user to be design vehicle and states that that typically is the WB-62. However, the manual offers the following direction to the designer when choosing the design vehicle:
 - » Passenger Car (P)- when the main traffic generator is a parking lot or a series of parking lots. *equivalent direction provided in AASHTO Green Book
 - » Single Unit Truck (SU) - at intersections with park roadways and residential streets. *equivalent direction provided in AASHTO Green Book
 - » BUS - at city streets which carry bus routes but have very few trucks and at park and ride facilities.
 - » *equivalent direction provided in AASHTO Green Book
 - » (WB-62) truck - at intersections with other trunk highways, high volume CSAHs and County Roads, and highly industrialized streets.

The curb-return is the curved connection of curbs where two streets come together to form an intersection.

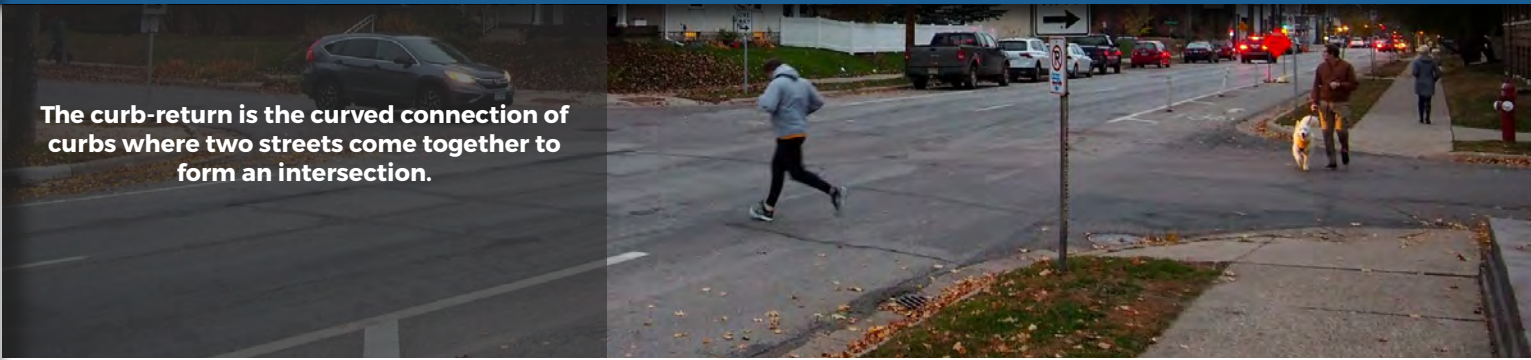

INTRODUCTION

The curb-return is the curved connection of curbs where two streets come together to form an intersection. The purpose of the curb-return is to guide vehicles in turning corners and to separate vehicular traffic from pedestrian areas at intersection corners. The curb-return radius refers to the curvature of the curb line when two streets come together.

Figure 3.7C.1:
Curb-return radii

Street Type	Curb-Return Radius (ft)
Intersection with a commercial street	18*
Intersections with a residential street	15*
Street where turns are prohibited (e.g. one-way streets)	5
Alley	5

* Note that radii assumptions for commercial and residential streets predates our current street typologies and may be updated in future revisions to the Street Design Guide.

^a This table represents typical curb radius assumptions based on street type and configuration. Note that deviations from this table are commonly anticipated to accommodate unique intersection geometry or necessary design/control vehicles.

DESIGN CONSIDERATIONS

A. Use smallest practical radius

The smallest practical curb-return radius should be used at all intersections to manage the speed of turning vehicles, shorten the length of pedestrian crosswalks, and provide adequate space at the corner for properly aligned [curb ramps](#). It is important to choose a practical radius as selecting design and control vehicles smaller than appropriate can compromise the safety of people biking and walking, as large vehicles may be required to frequently mount the curb to complete a turn. Extra attention should be paid to tightening curb-return radii where:

- » There are adjacent or nearby trip generators where high pedestrian volumes are observed or anticipated;
- » Turning vehicles will cross a protected bike lane, shared use path, or trail;
- » There is no existing or anticipated future need to regularly accommodate large turning transit buses or trucks; and
- » Where adjacent parking lanes, on-street bike lanes, or striped shoulders create a larger effective radius.

B. Use design and control vehicle guidance

The [design and control vehicles](#) identified for an intersection inform the curb radii that should be used.

C. Where turns are prohibited

Where turning movements are prohibited, such as at one way streets, a 5' corner radius should be used.

D. Alleys

A 5' corner radius is typically used for alleys.

E. Actual vs. effective radius

The actual curb-return radius may differ from the effective radius when on-street parking, an on-street bike facility, or a striped shoulder is adjacent to the outside travel lane (see Figure 3.7C.2). AutoTurn movements should consider the effective radius and a tighter actual radius should be implemented whenever practical.

Figure 3.7C.2: Actual vs. effective curb radius

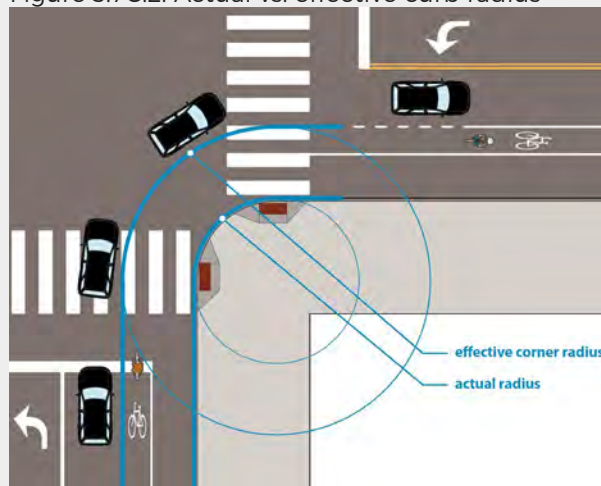

F. Strategies to tighten radii

To achieve the smallest practical curb-return radii, the following design strategies may be considered:

- » Implementing a compound radius so that the radius is smaller as drivers approach the crosswalk and larger as they continue through the intersection to complete the turn;
- » Implementing an [advanced stop bar](#) so control vehicles can encroach into the opposing or adjacent travel lane to complete a turn; and
- » Implement an access or turning restriction depending on adjacent land use and traffic network needs.

Supporting safe pedestrian crossings is essential to reaching City goals to support and promote walking and rolling and to reach Vision Zero.



INTRODUCTION

Supporting safe pedestrian crossings is essential to reaching City goals to support and promote walking and rolling and to reach Vision Zero. The Minneapolis [Complete Streets policy](#) establishes a modal framework that prioritizes serving the needs of people walking and rolling first when planning for our transportation system and streets. 85% percent of all traffic crashes involving pedestrians happen at intersections.

The Transportation Action Plan [Walking Strategy 2](#): “Prioritize visibility and safety of pedestrians at intersections and midblock crossings” offers additional steps the City is taking related to pedestrian crossings. This section will be updated as actions from this strategy are implemented.

Legal crosswalk definition

Whether marked or unmarked, legal crosswalks exist at all legs of all intersections where sidewalks normally exist, including T-intersections, except where closed and appropriately signed. Legal crosswalks also exist at marked midblock crossings. Minnesota state statute [section 169.011](#) defines a crosswalk as:

(1) that portion of a roadway ordinarily included with the prolongation or connection of the lateral lines of sidewalks at intersections; (2) any portion of a roadway distinctly indicated for pedestrian crossing by lines or other markings on the surface.

As defined in [Minnesota Statutes Section 169.21](#), motorists are required to stop for pedestrians who have entered a legal crosswalk. Pedestrians are also permitted to cross the street between intersections, provided they yield right of way to vehicles and they do not cross between adjacent intersections with traffic signals.

GENERAL DESIGN CONSIDERATIONS FOR PEDESTRIAN CROSSINGS

A. Accessibility	Pedestrian crossings must be accessible for people with disabilities, including use of ADA-compliant curb ramps and accessible pedestrian signals at new or replaced traffic signals.
B. General principles	<p>Pedestrian street crossing design should also include:</p> <ol style="list-style-type: none"> 1. Frequent crossing opportunities appropriate to the context; 2. Narrowing the roadway as much as possible to reduce exposure to pedestrians; 3. Tightening curb-return radii as much as feasible while balancing turning needs and pedestrian curb ramp design; 4. Clear expectations on where and when to cross the street for both pedestrians and drivers; 5. Good sidewalk visibility between drivers and pedestrians by limiting obstructions and providing good lighting on crosswalks; 6. Sufficient signal time and traffic gaps for pedestrians of all ages and abilities to cross the street; and 7. Minimal delay to pedestrians waiting to cross the street.
C. Slip lanes restricted	Slip lanes (unsignalized turn lanes at intersections) should be restricted and existing slip lanes should be converted to community space where possible.
D. Curb extensions	Curb extensions should generally be used at all intersections where full-time parking lanes are present or excess travel lane width is present. Exceptions include Urban Neighborhood streets where a traffic circle is preferred and Production and Processing where they should be considered but may not be appropriate given the frequency of large trucks.
E. Raised pedestrian crossings	Raised pedestrian crossings should generally be included whenever there a busier pedestrian street (like Mixed Use Commercial Connectors) crosses an Urban Neighborhood Street and should be considered when there is a high-volume pedestrian crossing of a parkway. See raised pedestrian and bicycle crossings guidance for more details.
F. Crossing improvements for busy streets	When there is a high-volume pedestrian crossing of a busier street (like Urban Neighborhood Connector, Mixed Use Community Connector, or Mixed Use Commercial Connector), pedestrian crossing improvements should be included. Options include traffic signals, bicycle and pedestrian safety islands , curb extensions , and/or Rectangular Rapid Flashing Beacons.
G. Crossing improvements for priority routes	Pedestrian crossing improvements should be further prioritized along and across the Pedestrian Priority Network and High Injury Streets and near or connecting to schools and parks.
H. Shared use paths	See also guidance for shared use path crossings .

It is critical that pedestrians at the corner have a good view of the travel lanes and that motorists in the travel lanes can easily see pedestrians.

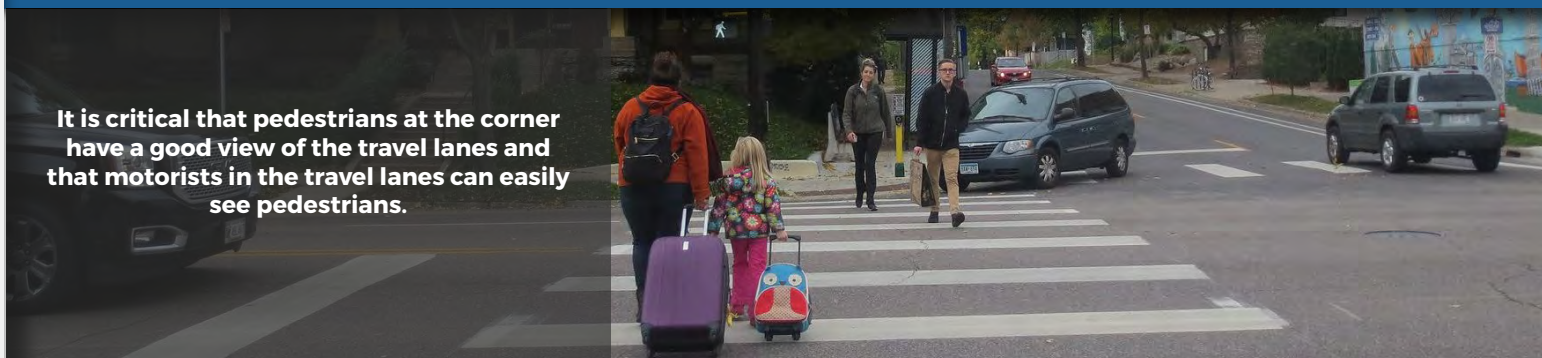

INTRODUCTION

It is critical that pedestrians at the corner have a good view of the travel lanes and that motorists in the travel lanes can easily see pedestrians. Visibility between motorists and pedestrians can be impeded by parked vehicles near the intersection or by other vertical elements, such as buildings, fences, hedges, and walls.

Current parking ordinances restrict parking within the vicinity of intersections to increase the visibility of pedestrians. Minneapolis ordinance prohibits on-street parking near intersections as follows:

- Within 20' of a legal pedestrian crossing (whether marked or unmarked) at an intersection unless otherwise allowed by a parking meter or traffic sign;
- Within 30' of the approach of a stop sign or traffic signal unless allowed by a parking meter or traffic sign; and
- Within 5' of an alleyway or driveway.

DESIGN CONSIDERATIONS

A. Parking and curb extensions	Parking should generally not be allowed within 30' of a stop sign or traffic signal and within 20' of a marked or unmarked crosswalk. Curb extensions should generally be included near an intersection if there is full-time on-street parking.
B. Trees	Street trees should not be located within 40' of an approaching cross street and within 20' of a non-approaching cross street (see Figure 3.7D.1).
C. Vertical objects	Other vertical objects that obstruct visibility between pedestrians and motorists should generally not be included within 30' of the intersection except traffic control devices or necessary safety equipment. Plantings should generally be shorter than 3' tall within 30' of the intersection to maintain visibility.
D. Additional Guidance	<ol style="list-style-type: none"> 1. See also protected intersections guidance when there is a sidewalk-level protected bike lane. 2. See also street lighting guidance.

3.7D Sidewalk visibility

Figure 3.7D.1:
Sidewalk visibility at intersections

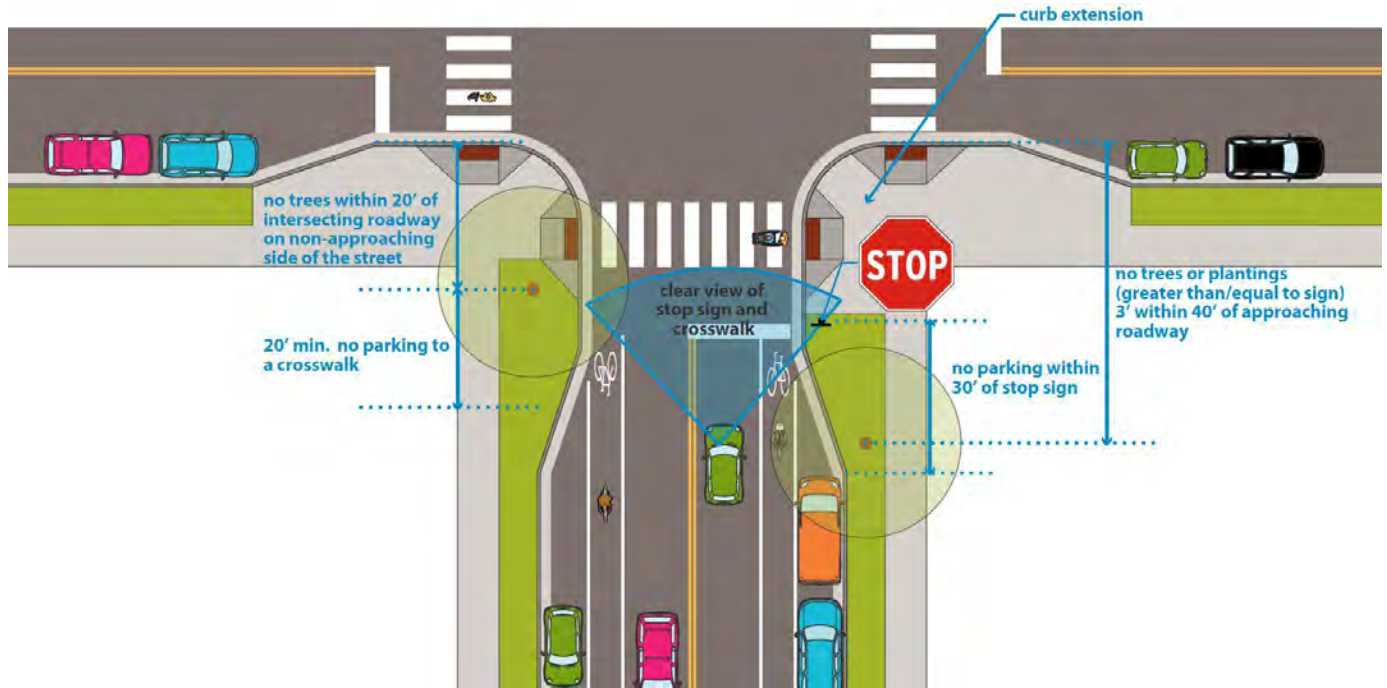



Curb ramps are the transitions between the sidewalks and street crossings.

INTRODUCTION

Curb ramps are the transitions between the sidewalks and street crossings. ADA-compliant pedestrian curb ramps must be provided at all legal intersections where sidewalk connections exist to provide access for people using mobility devices.

DESIGN CONSIDERATIONS

A. Detailed guidance	Designers should use MnDOT's current curb ramp guidelines , curb ramp standard plans , and other design guidance and standards for constructing curb ramps.
B. Desirability of ramp types	Figure 3.7D.2 describes several pedestrian curb ramp designs and indicates in general when each design might be used. This table does not encompass all of the options for pedestrian curb ramps, but instead outlines the pros and cons of the most common designs.
C. Additional Guidance	When there is an adjacent sidewalk-level protected bike lane, see also protected intersections guidance .

Figure 3.7D.2:
Ramp types and desirability

RAMP TYPE	RAMP IMAGE	DESIRABILITY	PROS	CONS
1. Combined Directional		Very Desirable	<ul style="list-style-type: none"> ▪ Provides directionality ▪ Aids in snow clearing ▪ Can be placed next to vertical obstructions ▪ Wayfinding for visually impaired 	<ul style="list-style-type: none"> ▪ Requires a lot of ROW (needs boulevard), ie. a small curb radius and/or large pedestrian zone
2. Parallel / Perpendicular Ramps		Acceptable	<ul style="list-style-type: none"> ▪ Fits in constrained conditions 	<ul style="list-style-type: none"> ▪ Typically not aligned with direction of travel ▪ Multiple grade changes required in through walk zone

RAMP TYPE	RAMP IMAGE	DESIRABILITY	PROS	CONS
3. Blended Transition / Depressed Corner/ Fan Ramp		Acceptable , less desirable than bi-directional ramps	<ul style="list-style-type: none"> ▪ Fits in constrained conditions (little ROW) ▪ Ramp is in line with through walk zone 	<ul style="list-style-type: none"> ▪ Not good in low elevations (drainage concerns) ▪ Plows leave snow at front of ramp ▪ Easier for vehicles to drive on
4. Single Diagonal Ramp		Undesirable but acceptable if no other ramp type will work	<ul style="list-style-type: none"> ▪ Fits in constrained conditions 	<ul style="list-style-type: none"> ▪ Not aligned with direction of travel, requires wheeled users to redirect in road ▪ Plows leave snow at front of ramp ▪ No space for pedestrian signals



Crosswalks can be marked or unmarked. Marked crosswalks provide extra visibility and clarify where pedestrians will be crossing.



INTRODUCTION

Crosswalks can be marked or unmarked. Whether marked or unmarked, legal crosswalks exist at all legs of all intersections where sidewalks exist except where closed and appropriately signed. Marked crosswalks provide extra visibility and clarify where pedestrians will be crossing.

DESIGN CONSIDERATIONS

A. Markings

Minneapolis uses high visibility “continental” crosswalk markings whenever marking a crosswalk. The stripes in the marked crosswalk should be between 1'-2' wide and spaced 1'-3' apart and should cover the full crosswalk area.

B. Stop bars

An advanced stop bar should generally be included with marked crosswalks. See [advanced stop bars guidance](#) for more details.

C. Location

Marked crosswalks are generally included at all legal crossings at signalized intersections and at other priority crossings. City procedures on where to mark high visibility crosswalks are being updated.

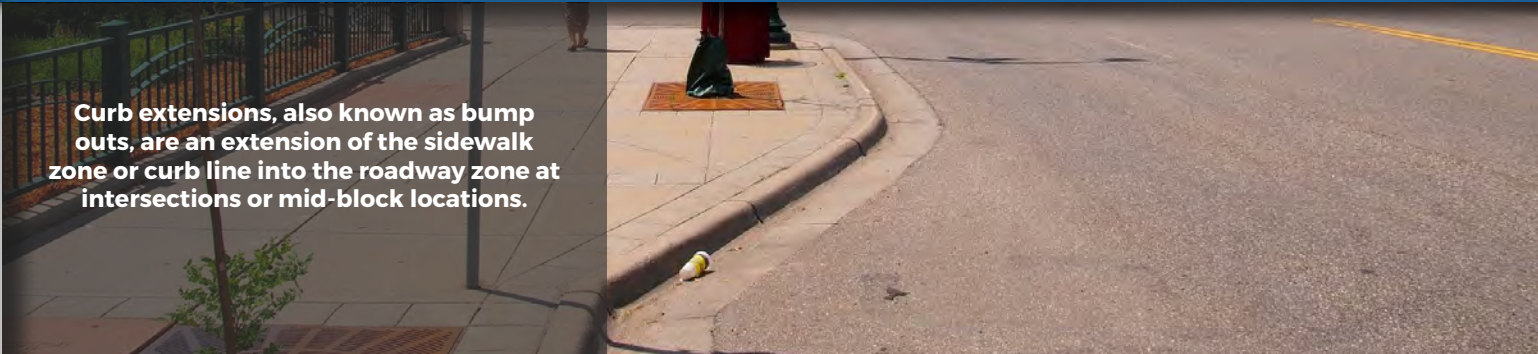

Curb extensions, also known as bump outs, are an extension of the sidewalk zone or curb line into the roadway zone at intersections or mid-block locations.

INTRODUCTION

Curb extensions, also known as bump outs, are an extension of the sidewalk zone or curb line into the roadway zone at intersections or mid-block locations. Curb extensions are intended to increase safety, calm motorized traffic, and create additional space for pedestrians and the boulevard and furnishing zone.

Curb extensions provide the following benefits:

- Improved sightlines between vehicles and pedestrians.
- Reduced pedestrian crossing distance, thereby reducing pedestrian exposure to potential vehicle conflicts.
- Additional pedestrian queuing space before crossing.
- Can slow vehicle turning speeds by decreasing turning radii and visually narrowing the roadway.
- Additional corner space to fit two perpendicular curb ramps per corner, utilities and traffic control, furnishings, greening, transit facilities, bicycle parking, and sidewalk cafes.
- Additional pervious space for green stormwater infrastructure.
- Restrict cars from parking too close to the intersection and inhibiting sightlines.

3.7D Curb Extensions

Figure 3.7D.3:
Curb extensions

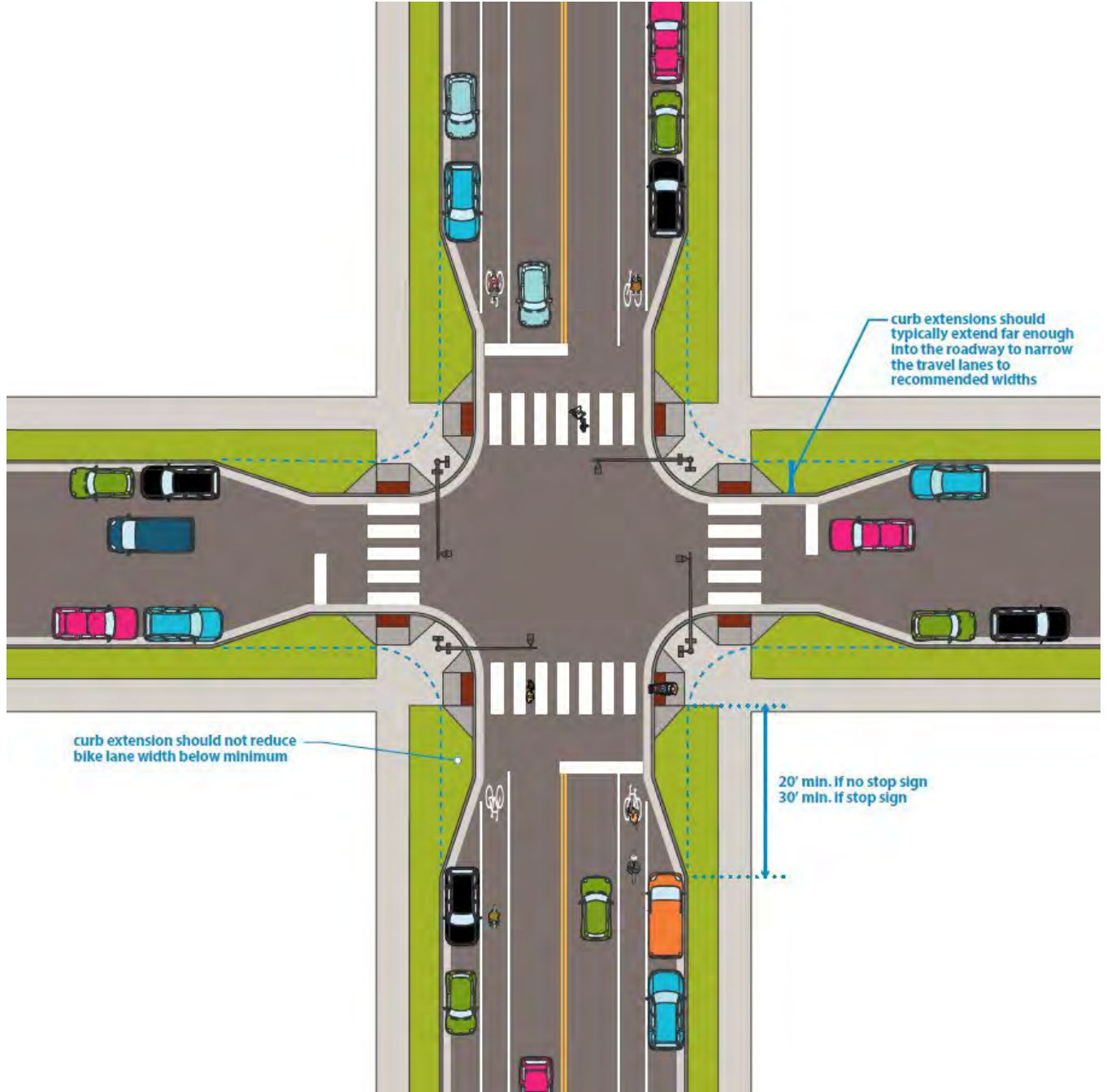

DESIGN CONSIDERATIONS

A. Location	<ol style="list-style-type: none"> 1. Curb extensions should generally be used at all intersections where full-time parking lanes are present or excess travel lane width is present. <ul style="list-style-type: none"> o Exceptions include Urban Neighborhood streets where a traffic circle is preferred and Production and Processing where they should be considered but may not be appropriate given the frequency of large trucks. 2. Curb extensions may extend into one or multiple legs of an intersection depending on the configuration of parking lanes. 3. Curb extensions can also be used midblock to support additional greening and traffic calming or for midblock pedestrian crossings.
B. Width	<ol style="list-style-type: none"> 1. Curb extensions should typically extend far enough into the roadway to narrow the travel lanes to recommended widths (see lane widths guidance). 2. The gutter of the curb extensions should be outside of the vehicular travel lane and should not reduce bike lane width below the constrained minimum (see bike lane width guidance). 3. With a typical 8' parking lane on a street with recommended lane widths, the curb extension would be 6' wide. 4. Curb extensions should not reduce the curb-to-curb width to less than 13' to ensure emergency vehicle and winter maintenance vehicle access. Coordinate with Fire Department if narrowing curb-to-curb width to 14' or narrower.
C. Length	<ol style="list-style-type: none"> 1. Curb extensions (including the taper) should be at least 20' in length when there is not a stop sign and at least 30' in length if there is a stop sign. This minimum is based on typical crosswalk dimensions and ordinances requiring no parking within 20' of a crosswalk or 30' of a stop sign. 2. Longer curb extensions may be desired, depending on needs for greening, transit stops, sidewalk cafes, other furnishings, or snow storage. Designers should balance those needs with right-sizing the amount of on-street parking when determining the length of curb extensions.
D. Turning Movements	<p>The turning movements of design and control vehicles should be considered when designing new curb extensions; see design and control vehicle guidance for additional information.</p> <ol style="list-style-type: none"> 1. When curb extension locations conflict with necessary turning movements, consider reducing curb extension dimensions before eliminating.
E. Curb Ramps	<p>Where possible, design curb extensions to fit two perpendicular curb ramps aligned with the sidewalk and crosswalk.</p>

F. Bikeway considerations	<ol style="list-style-type: none"> 1. Curb extensions may complicate the installation of future bike facilities and should be designed and implemented with consideration for the existing and proposed AAA bike network. 2. Curb extensions may be constructed or retrofitted to transition on-street bikeways from street to sidewalk-level behind the curb by employing bicycle-specific slip ramps up and down stream of the intersection. This should be prioritized when rebuilding signalized intersections or quadrants along AAA bike routes with existing on-street bike lanes. <p>On neighborhood greenways: bicycle boulevards where bikes travel in mixed flow with vehicles, curb extensions should not force cyclists to merge unexpectedly with cars at the end of the block.</p>
G. Sightlines and pedestrian clear zone	<p>Street furniture, trees, plantings, or other amenities included in the curb extension area should not impede sightlines or redirect the pedestrian clear zone at intersections. See sidewalk visibility guidance for more details.</p>
H. Maintenance	<p>Curb extensions need to be carefully designed to drain properly and to avoid ice, leaf, and road debris buildup.</p>
I. Drainage	<p>Curb extensions may impact existing catch basin locations, underground utilities, and curbside uses. These impacts should be evaluated during the scoping process as they may increase costs significantly.</p>
J. Transit	<p>For transit related curb extension design considerations, please reference transit stops.</p>
K. Delineator curb extensions	<p>Low-cost curb extensions can be implemented using delineators in street retrofit project</p>

An advanced stop bar is a solid white line striped in advance of crosswalks that encourage drivers to stop further back from crosswalks.

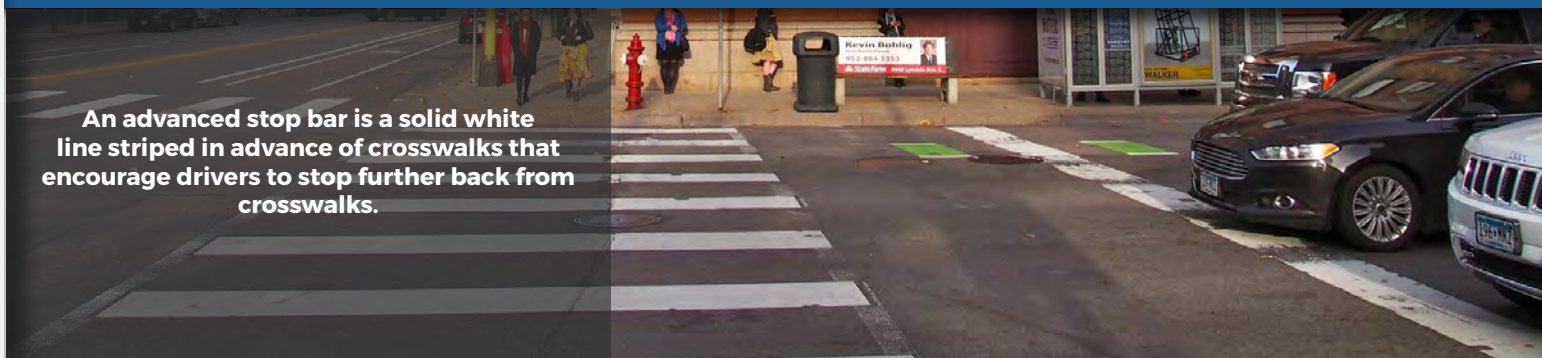

INTRODUCTION

An advanced stop bar is a solid white line striped in advance of crosswalks that encourage drivers to stop further back from crosswalks at intersections or at midblock crossings.

DESIGN CONSIDERATIONS

A. When to Use

1. Advanced stop bars are typically installed in advance of:
 - » Marked crosswalks at signalized intersections;
 - » At midblock pedestrian crossing locations with marked crosswalks;
 - » Marked crosswalks where rectangular rapid flash beacons (RRFBs) are installed;
 - » [Bike boxes](#) to reduce vehicular encroachment into the bicycle queuing space.
2. Advance stop bars can be considered when turning movements require encroachment into opposing travel lanes. At skewed intersections or space-constrained corridors, accommodating necessary turning movements may require encroachment into the opposing travel lane. In these scenarios, advanced stop bars should be employed to indicate the intended stopping location and allow turning vehicles to complete turns without conflicts with queuing through traffic.
3. Advance stop bars can be considered at unusual stop locations. At locations where the stop location associated with a traffic signal is different than usual, for example where auxiliary traffic signal heads stop traffic in advance of an intersection; or where the physical conditions fail to indicate clearly the intended stopping position, advanced stop bars may be employed along with "STOP HERE ON RED" signage to reinforce the preferred stopping location.

B. Striping location

1. Advanced stop bars are typically striped 10' in advance of crosswalks.
2. On unsignalized marked crosswalks on multi-lane roadways, consider placing stop bar 20'-30' in advance of the crosswalk to improve visibility. Multi lane roadways present a unique threat to pedestrians crossing, as vehicles in one lane can block the visibility of a motorist traveling in the adjacent lane.
3. When advanced stop bars are employed to accommodate turning movements that encroach into opposing travel lanes, stop control, signage, and stop bar placement must be coordinated to accommodate the anticipated turning movement.

Raised pedestrian and bicycle crossings combine a speed hump with a crossing point.

INTRODUCTION

Raised pedestrian and bicycle crossings combine a speed hump with a crossing point. They support slower, safer traffic speeds at crossing points.

Figure 3.7D.4: Raised pedestrian and bicycle crossings

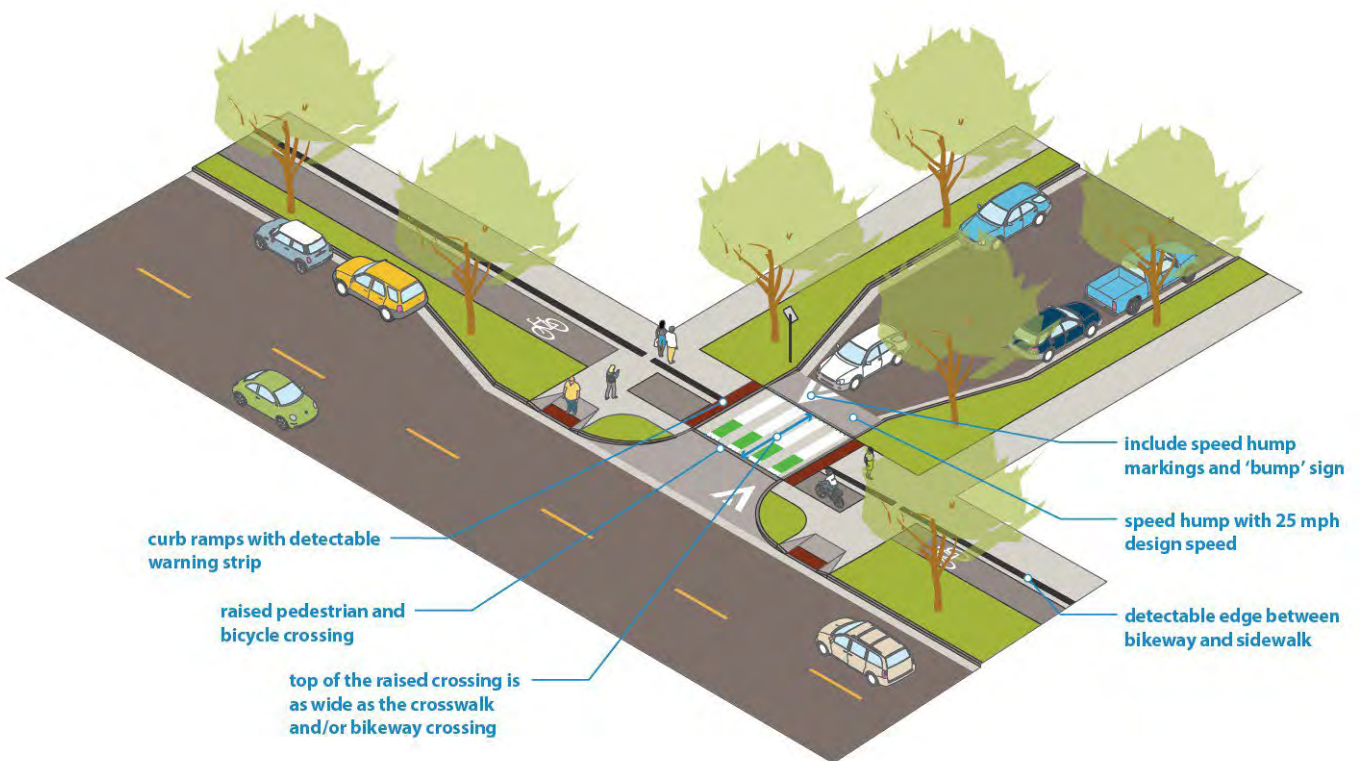

DESIGN CONSIDERATIONS

A. When to Use	<ol style="list-style-type: none"> 1. Raised pedestrian and bicycle crossings should generally be included with street reconstruction projects at busy pedestrian crossings, sidewalk-level protected bike lanes, or shared use paths when they cross an Urban Neighborhood street. 2. Raised crossings should also be considered for busy pedestrian and bicycle crossings across Parkways. 3. Raised crossings can be used at intersections or at midblock crossings. 4. Raised crossings are still be evaluating for use at signalized intersections. Conflicts with accessible pedestrian signal poles can present challenges at signalized locations. 5. Raised crossings generally should not be included across street types other than Urban Neighborhood and Parkway. 6. Raised crossings can be considered for street retrofit projects, although cost and drainage factors will limit their use in retrofits.
B. Design speed	<p>Raised pedestrian and bicycle crossings should typically be designed with a 25 mph design speed. To encourage slower speeds, drivers should notice a vertical difference when crossing over the raised crossing.</p>
C. Height	<p>Raised crossings should generally be designed to minimize the vertical difference of the pedestrian and bicycle crossing. The height of a specific raised crossing should be determined based on local factors, including drainage and nearby street grades.</p>
D. Detectable warning strip	<p>Detectable warning strips (typically made of truncated domes) must be installed on the edge of sidewalk to alert users that they are about to enter the roadway. See MnDOT's current curb ramp guidelines, curb ramp standard plans, and other design guidance and standards for details on constructing detectable warnings.</p>
E. Markings and signage	<p>Raised crossings should include a marked crosswalk and, where appropriate, marked bikeway crossing along with pedestrian crossing sign. They should also include standard speed hump markings and "BUMP" roadway marking or "BUMP" signage.</p>
F. Width	<p>The top of the raised crossing should generally be as wide as the crosswalk or bicycle crossing.</p>
G. Drainage	<p>Drainage challenges may limit the feasibility of using a raised pedestrian and bicycle crossing and need to be considered early in the design process.</p>
H. Midblock crossings	<p>See also NACTO guidance for midblock crosswalks for additional considerations.</p>
I. Coordinate with Fire department	<p>It's important that the raised crossing is designed to ensure that fire truck access is maintained. Work with Fire department staff on details for new raised crossings.</p>
J. Notification for winter plowing	<p>Ensure that Transportation Maintenance and Repair staff are aware of new raised crossings so plow drivers can plan accordingly.</p>
K. Evaluation	<p>Raised crossings are still be evaluated; this guidance may evolve in the future with further evaluation.</p>

3.7D Pedestrian and Bicycle Safety Islands

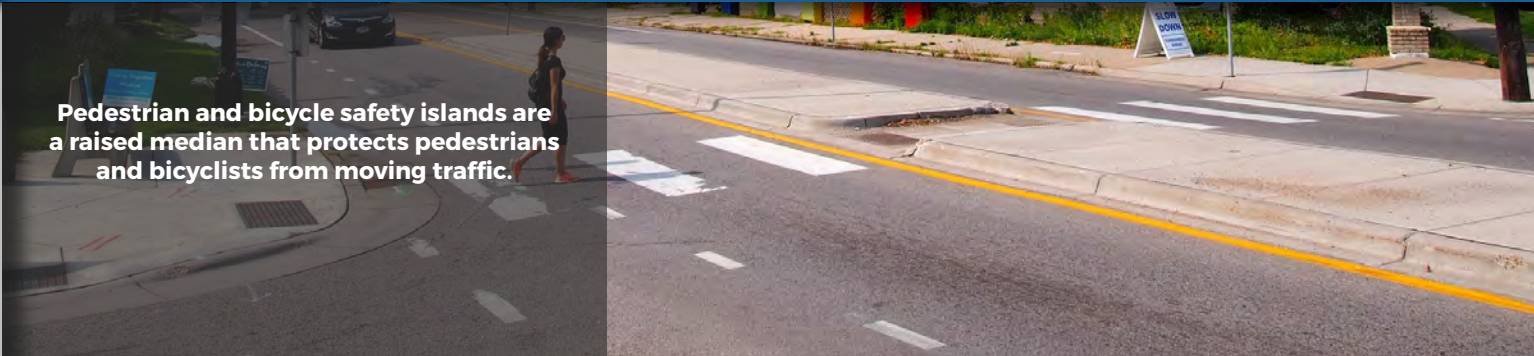

Pedestrian and bicycle safety islands are a raised median that protects pedestrians and bicyclists from moving traffic.

INTRODUCTION

Pedestrian and bicycle safety islands are a raised median that protects pedestrians and bicyclists from moving traffic. Safety islands allow pedestrians and bicyclists to navigate one direction of traffic at a time when crossing.

Figure 3.7D.5: Pedestrian and bicycle safety islands

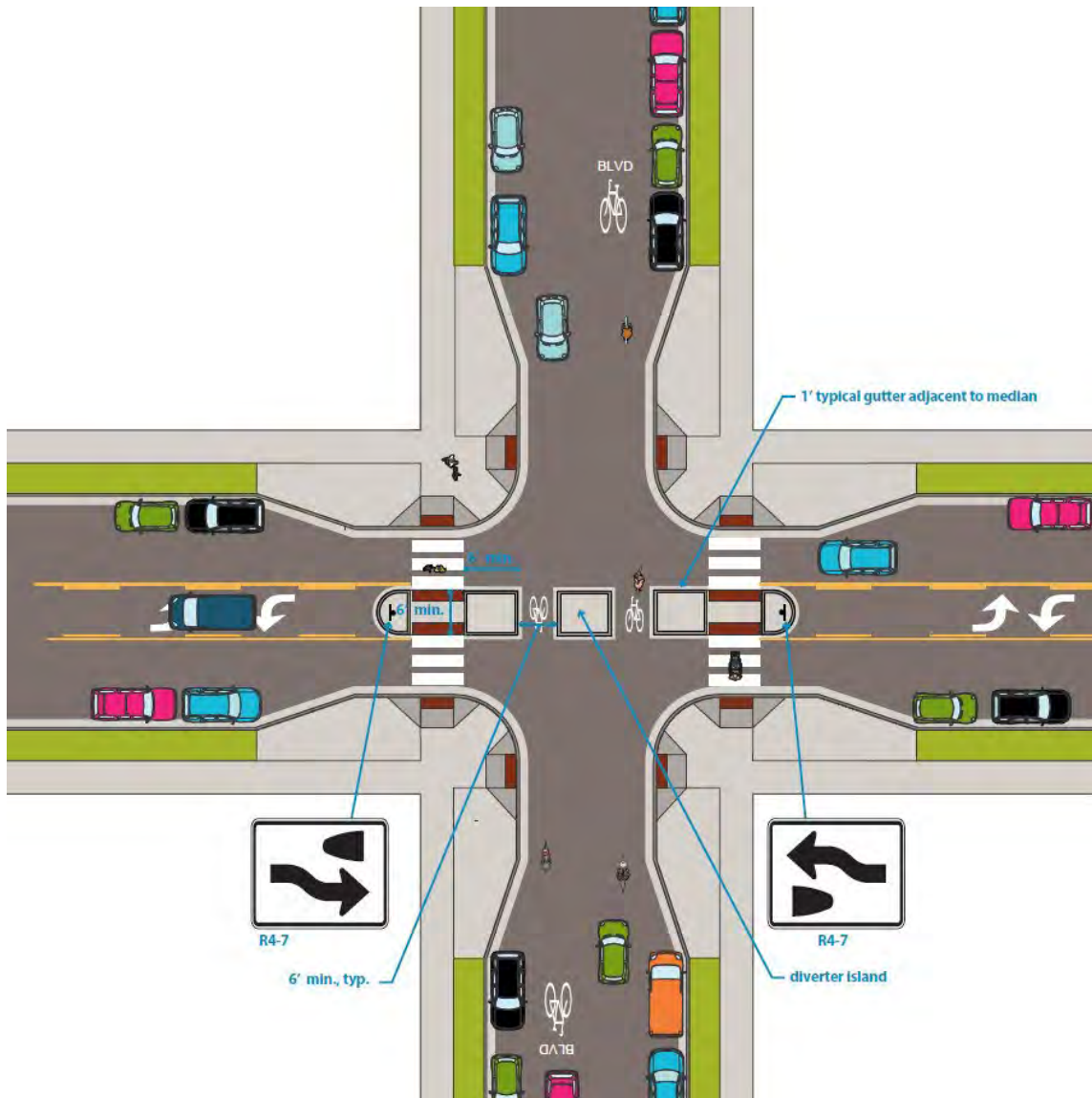

DESIGN CONSIDERATIONS

A. When to use	<ol style="list-style-type: none"> 1. Pedestrian and bicycle safety islands should be considered when there is a neighborhood greenway or high-volume pedestrian crossing across a busier street such as Mixed Use street types and Urban Neighborhood Connector streets. 2. Safety islands should generally be used at unsignalized crossings (signalized crossings should generally prioritize curb extensions). 3. Pedestrian and bicycle safety islands can be implemented at intersections or at midblock crosswalks or trail crossings.
B. Location	<ol style="list-style-type: none"> 1. Safety islands are located in the middle of the roadway. 2. They are often included in the space of a left-turn lane, but also can be implemented on streets without turn-lanes if there is space for a lane shift (for example, by removing parking leading up to the crossing). 3. Safety islands can be used on one or both crosswalks on either side of a street.
C. Cut-through design	<ol style="list-style-type: none"> 1. A cut-through design where the crosswalk remains at street level through the safety island is strongly preferred over ramping up to the island. 2. The cut through should preferably be the same width as the crosswalk and always be at least 6'. See Figure 3.7D.5.
D. Nose	<p>When feasible, safety islands should include a nose that extends past the crosswalk and protects people waiting on the island and slows turning drivers.</p>
E. Width	<ol style="list-style-type: none"> 1. Safety islands should be at least 6' wide although 8' or wider should be considered along major bicycle crossings to provide adequate space for bicyclists. 2. Where a 6'-wide median cannot be attained, a narrower raised median can still be preferable to nothing.
F. Length	<ol style="list-style-type: none"> 1. The length of safety islands varies, but should be at least 6' long. 2. Longer medians of adequate width can accommodate trees if they are setback at least 40' from the intersection; see street trees guidance for more details.
G. Detectable warning surface	<ol style="list-style-type: none"> 1. Detectable warning surfaces made of truncated domes must be installed on the edge of safety island crosswalk to alert users that they are about to enter the roadway. 2. See MnDOT's current curb ramp guidelines, curb ramp standard plans, and other design guidance and standards for details on constructing detectable warnings.
H. Curb and gutter	<p>Standard 6" curb tops and 1' gutters are generally used adjacent to medians. If there are catch basins adjacent to medians, 2' gutters should typically be used.</p>
I. Signage	<p>A Keep Right (R4-7) should be included at the start of the safety island.</p>
J. Diverter islands	<p>Safety islands can be implemented with a diverter to restrict traffic along neighborhood greenways or eliminate vehicle crossing at unsignalized intersections with high crash rates. Coordinate with the Fire Department if considering a diverter. See Figure 3.7D.5.</p>

K. Including other crossing improvements	Safety islands should be implemented with marked crosswalks and bikeway crossing markings as appropriate. Designers should also consider advanced stop bars , curb extensions , enhanced street lighting , and rectangular rapid flashing beacons (RRFBs) in conjunction with the safety island.
L. Turning vehicles	Safety islands may restrict turning movements to and from intersecting streets. Designers should consider appropriate design and control vehicles and model all turning movements.
M. Greening	Designers should generally work to include greening in medians whenever feasible. See medians guidance for more details.
N. Midblock crossings	See also NACTO guidance for midblock crosswalks for additional considerations.
O. Delineator safety islands	Low-cost safety islands can be implemented using delineators in street retrofit projects.

Most crashes between people bicycling and motorized traffic occurs at intersections.



INTRODUCTION

Most crashes between people bicycling and motorized traffic occurs at intersections. Focusing design strategies on the intersection to minimize exposure and risk from vehicles is key to improving safety and comfort for bicyclists.



Bike lane adjacent to Dedicated Turn Lanes

INTERSECTION TREATMENT PRIORITIZATION

The intersections treatments that best support safety and comfort will vary depending on the bikeway design and roadway cross section, adjacent land uses, and expected movements through the intersection. Even with a single bicycle facility type, intersection design best practices will vary depending on whether the intersection is a major intersection with high traffic volumes, or a minor intersection with low volumes. See Figure 3.7E.1 for guidance on what intersection treatments to pursue at major and minor intersections depending on bicycle facility type.

Figure 3.7E.1: Bike lane intersection design implementation matrix

Bicycle Facility Type	Recommended Intersection Treatment	
	Major Signalized Intersections ^a	Minor Unsignalized Intersections ^b
Sidewalk-Level Protected Bike Lanes (One-way)	Protected Intersection Only	Raised Crossing
Sidewalk-Level Protected Bike Lanes (Two-way)	Protected Intersection Only	Raised Crossing
In-Street Protected Bike Lanes (One-way)	Protected Intersection Preferred, Mixing Zones Allowed	Mixing Zones Allowed
In-Street Protected Bike Lanes (Two-way)	Protected Intersection Only	Physical bikeway delineation to the intersection, Mixing Zones NOT allowed
Neighborhood Greenway (Full Greenway)	Protected Intersection, Targeted Crossing Enhancements ^c	Raised Crossing, Access Control
Neighborhood Greenway (Bicycle Boulevard)	Targeted Crossing Enhancements ^c	Traffic Circles, Curb Extensions, Access Control
Shared Use Path	Targeted Crossing Enhancements ^c	Raised Crossing, Access Control
Trail	Protected Intersection, Targeted Crossing Enhancements ^c	Raised Crossing, Access Control
Unprotected Bike Lanes (All types)	Mixing Zones Allowed	Mixing Zones Allowed

a Typically across Downtown Core, Mixed Use Regional Connector, Mixed Use Commercial Connector, Mixed Use Community Connector, and some Production and Processing Streets.

b Typically across Urban Neighborhood, Urban Neighborhood Connector, Parkway, and some Production and Processing streets.

c Includes a variety of crossing enhancements such as medians, access control, curb extensions, leading bicycle signal intervals, and bicycle-specific signal phasing.

Protected intersections allow for physical separation between bicycles and motorized traffic further into the intersection than a non-protected intersection.



INTRODUCTION

Protected intersections allow for physical separation between bicycles and motorized traffic further into the intersection than a non-protected intersection. Lacking the mixing zones of conventional intersections where people biking are required to mix with motorized traffic, well designed protected intersections reduce conflict points with motorized traffic, clarify travel paths through the intersection, and promote increased safety and comfort for the most vulnerable users of the roadway. Protected intersections are All Ages and Abilities facilities and should be pursued with all street reconstruction projects on the defined AAA Network. Protected intersections should also be pursued with retrofit projects on the AAA Network wherever feasible.

Protected intersections include several core elements:

- Bend-out/offset bikeway design;
- Pedestrian and bicycle forward queuing area; and
- Corner radius/corner Island.

DESIGN CONSIDERATIONS FOR FULL STREET RECONSTRUCTION PROJECTS

The following design considerations are specific to reconstruction projects where protected intersections are designed to accommodate sidewalk-level bike facilities. These can also apply to large-scale retrofit projects where the intersection quadrant will be fully reconstructed.

3.7E Protected intersections

Figure 3.7E.2: Protected intersections in street reconstruction projects

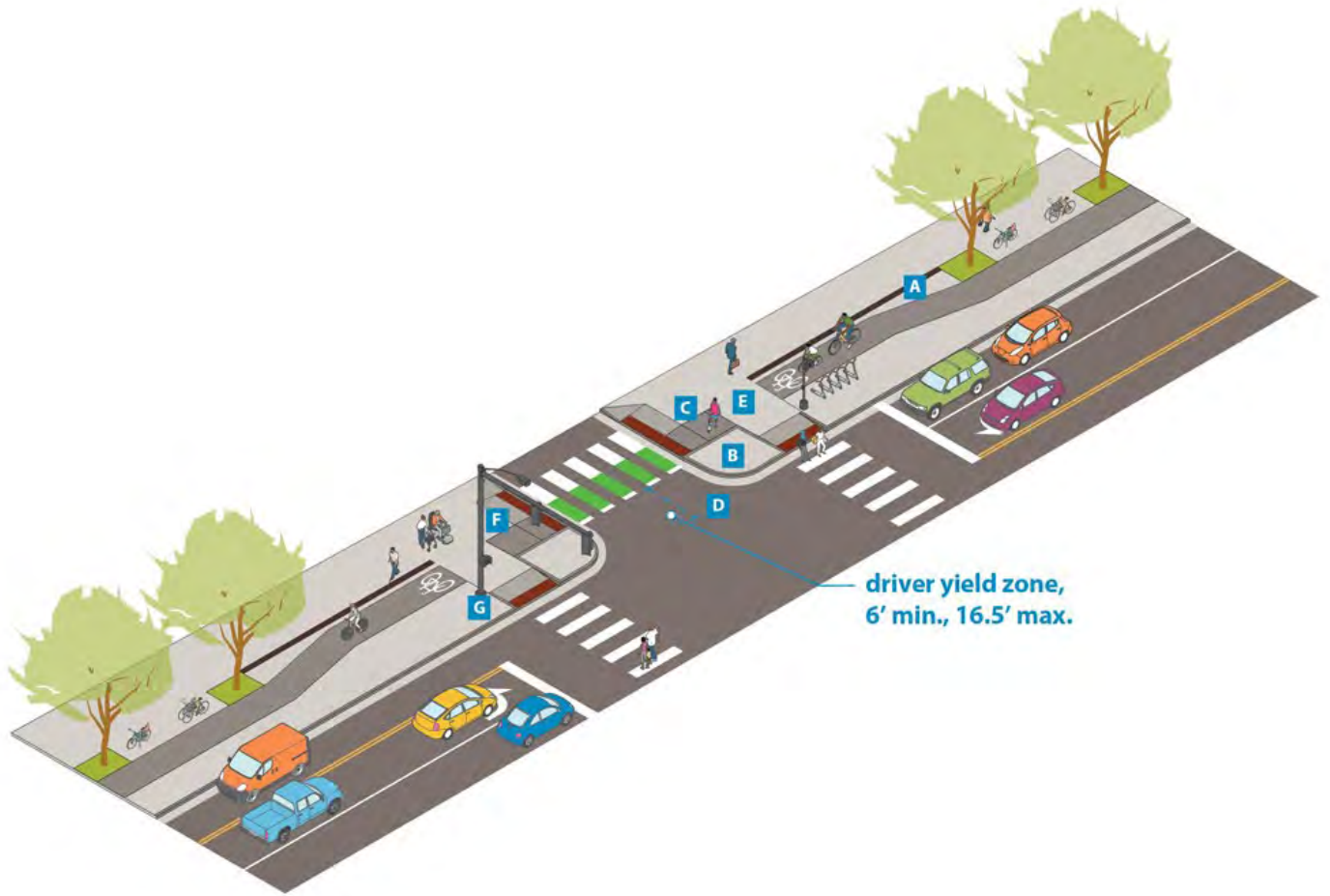

DESIGN CONSIDERATIONS FOR FULL STREET RECONSTRUCTION PROJECTS

A. Bend out/offset bike lane design

1. When sidewalk-level bike lanes are separated from the pedestrian clear zone by the boulevard and furnishing zone, it is recommended that the bike lane be designed to “bend-out” away from the roadway to set the bike lane further back at intersections. Bending out the bike lane improves sightlines, creates more space for vehicles to yield to bicyclists and pedestrians, and creates more pedestrian queuing space outside of the bikeway.
2. When the sidewalk-level bike lane and pedestrian clear zone are already adjacent, designers should use the boulevard and furnishing space between the roadway and bike lane to implement protected intersection elements, also referred to as an offset bike lane design. The pedestrian clear zone should generally continue straight through the intersection and not be bent out to support accessibility.
3. Sidewalk-level bike lanes should generally bend out to be adjacent to the pedestrian clear zone with a small buffer between; the width of the buffer will depend on the street context. A detectable edge should be considered between the pedestrian clear zone and bike lane (see [sidewalk-level protected bike lane guidance](#) for more details).
4. Sidewalk-level bend-out bike lanes should may employ a maximum later taper of 3:1, with more gradual taper angles preferred.
5. Steep bend-out tapers will require a State Aid variance if they require a bikeway design speed below 20 mph and should be considered in areas with higher pedestrian volumes to encourage safer travel speeds approaching pedestrian mixing zones.
6. The bend-out taper should end in advance of intersecting crosswalks to improve the visibility of approaching pedestrians.
7. On-street protected or un-protected bike lanes may transition to sidewalk-level bend-out protected intersections by employing bicycle-specific slip ramps up and down stream of the intersection. This should be prioritized when rebuilding signalized intersections or quadrants along AAA bike routes with existing on-street bike lanes.

B. Corner radius

1. The corner radius extends the physical separation of the bike lane to provide a queuing area, reduces crossing distances, and affords better sightlines and slower turning speeds for motorized traffic.
2. Smaller corner radii are preferred where feasible to reduce right-turning vehicle speeds. See [curb-return radii guidance](#) for more detail.
3. APS push-button placement at signalized intersections should be located outside of the travel path of bicycles and pedestrians while still maintaining required ADA spacing dimensions

C. Pedestrian and bicycle forward queuing area

1. The pedestrian and bicycle queuing area provides physically protected space for people walking or biking to queue while waiting to proceed through the intersection. This area is located farther forward than queuing areas in traditional (unprotected) intersections, making non-motorized users more visible to turning drivers.
2. The queueing area should be at least 6' long when feasible to accommodate the typical bicycle length and avoid encroachment into the pedestrian crosswalk.
3. The widths at the entry and exit of the crossing to the street should typically be the same width as the bike zone and no less than 6'.
4. When stops for bicyclists are required, stop bars for the bike lane should be placed near the edge of the crossing roadway.

D. Driver yield zone

1. Protected intersections with crossings set back from the intersection create additional spaced for turning motorized traffic to yield to bicyclists and pedestrians. This space is important to improving the safety of the protected intersection.
2. Preferred motorist yield zones are 16.5' wide, which is typically not feasible. Constrained minimum yield zones should be at least 6' wide.

E. Pedestrian and bicycle mixing zone

1. Pedestrian and bicycle mixing zones are areas where pedestrians are required to cross the bike lane before crossing the street. These mixing zones should be designed to indicate the preferred pedestrian crossing location across the bike lane and to communicate a clear message to bicyclists that pedestrians have the right-of-way.
2. Sidewalk-level bike lanes may include a mixing zone where bikes are intended to yield to pedestrians where a sidewalk crosses perpendicular to the bikeway, or where the bikeway and sidewalk share space at a corner.
3. Sidewalk-level bike lanes should differentiate the pedestrian and bicycle mixing zone by using standard concrete (rather than colored concrete for the bikeway) to communicate that pedestrians maintain the right of way.
4. Pedestrian crossings of the bike lane should be straight and align with the crosswalk in the street.
5. Detectable edges separating the bike lane and pedestrian clear zone should not continue through the mixing zone.

F. Curb ramps and crossings

1. [Curb ramps](#) are required when transitioning pedestrians and bicyclists from the sidewalk to the street. All efforts should be made to ensure acceptable grades are provide approaching and through the curb ramps.
2. When the pedestrian clear zone and bike lane are located adjacent to each other, a detectable warning strip made of truncated domes shall extend across both facilities.
3. If the pedestrian clear zone and bike lane are not adjacent, the detectable warning strip of truncated domes shall be exclusive to the pedestrian crossing to better orient users to the appropriate crossing.
4. Green conflict zone markings should be included across most streets.
5. A [raised crossing](#) should generally be included when a protected bike lanes crosses an Urban Neighborhood street and should be considered when crossing a Parkway.

G. Maintenance

1. Protected intersection design must accommodate access to and maintenance of stormwater infrastructure and design should be coordinated with Surface Water and Sewers.
2. Sidewalk-level bike lanes must maintain minimum bikeway widths and clearances at the intersection to accommodate routine maintenance and snow clearance/removal. See [sidewalk-level protected bike lane guidance](#) for details.

DESIGN CONSIDERATIONS FOR STREET RETROFIT PROJECTS

The following design considerations are specific to retrofit projects where protected intersections are designed to accommodate on-street bike lanes.

Figure 3.7E.3: Protected intersections in street retrofit projects

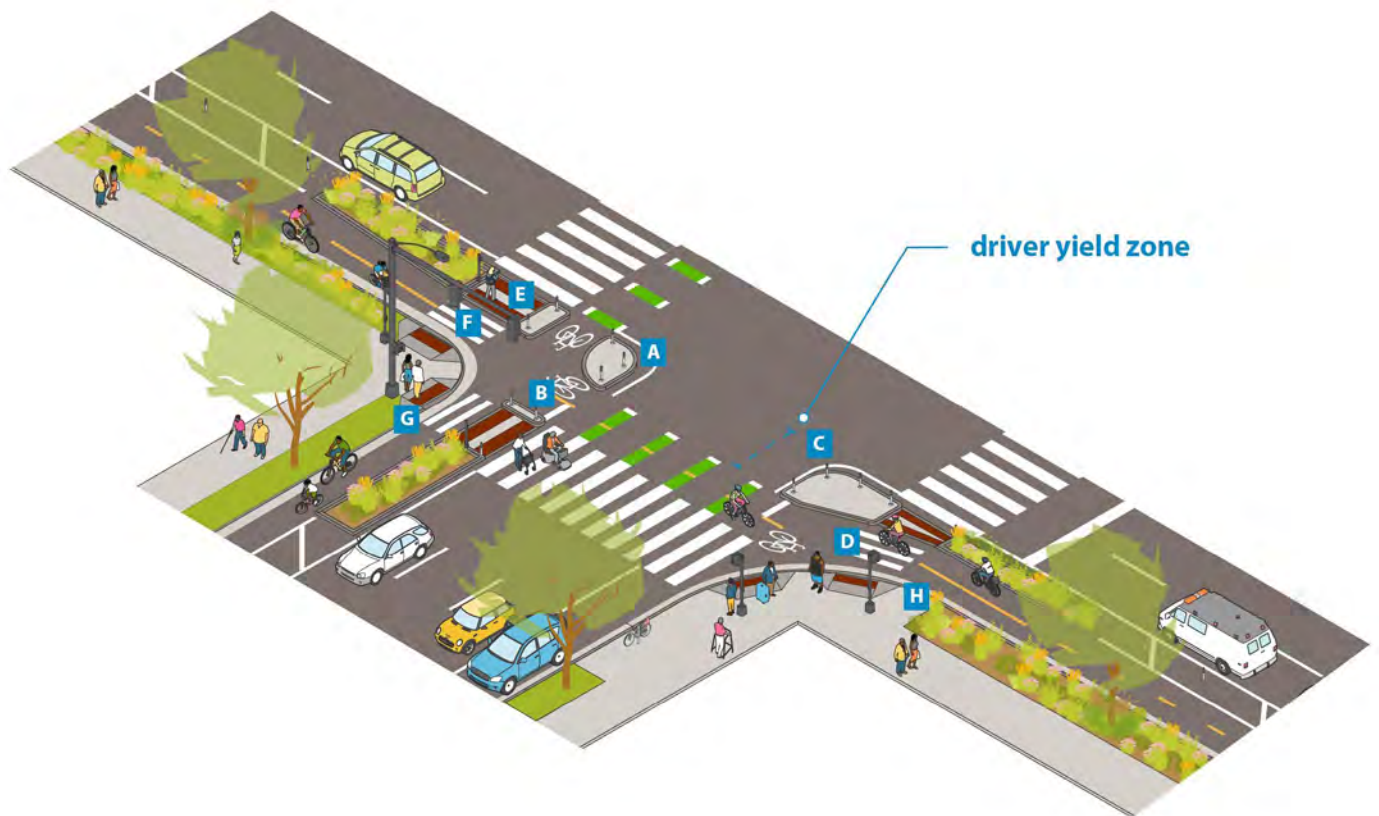

A. Corner island

1. The corner island extends the physical separation of the bike lane to provide a queuing area, reduces crossing distances, and affords better sightlines and slower turning speeds for motorized traffic.
2. Smaller radii are preferred for the corner island to reduce right-turning vehicle speeds. See [curb-return radii guidance](#) for more detail.
3. Corner islands may be constructed of concrete or plastic delineators.
4. Plastic-delineator corner islands may also include painted pavement to visually reinforce the intended corner geometry.
5. Consider the use of concrete or plastic-delineator curb extensions (LINK) in addition to striping to reinforce the preferred travel path through the intersection for motorized traffic, and to prevent motorized traffic from entering the bikeway

B. Bicycle forward queuing area

1. The bicycle queuing area provides physically protected space for people biking to queue while waiting to proceed through the intersection. This area is located farther forward than queuing areas in traditional (unprotected) intersections, making bicyclists more visible to turning drivers.
2. The queuing area should be at least 6' long to accommodate the typical bicycle length and avoid encroachment into the pedestrian crosswalk.
3. The widths at the entry and exit of the crossing to the street should typically be the same width as the bike zone and no less than 6'.
4. When stops for bicyclists are required, stop bars for the bike lane should be placed near the edge of the crossing roadway.
5. A street-level pedestrian queuing area may also be accommodated through the construction of a pedestrian crossing island.

C. Driver yield zone

1. Protected intersections with crossings set back from the intersection creates additional spaced for turning motorized traffic to yield to bicyclists and pedestrians. This space is important to improving the safety of the protected intersection.
2. Preferred motorist yield zones are 16.5' wide, which is typically not feasible. Constrained minimum yield zones should be at least 6' wide.
3. Achieving space for the driver yield zone can be done by using the corner island and a bend out/offset bike lane design.
4. At signalized intersections, green conflict zone markings should be striped across the intersection to indicate the preferred bicycle travel path and reinforce the motorist yield zone.

3.7E Protected intersections

D. Bend out/offset bike lane design

1. When space allows, it's recommended that on-street bike lane be designed to "bend-out" away from the motor vehicle lanes to set the bike lane further back at intersections. Bending out the bike lane improves sightlines to the bike lane and sidewalk by requiring turning vehicles to cross the bikeway at a more visible, less obtuse angle, creates a larger queuing area for vehicles to yield to non-motorized traffic and reduces back pressure on turning vehicles.
2. The bend out bike lane design may be accommodated for on-street bike lanes by using the space between the existing curb line and the corner island.
3. The bend out or taper should end in advance of the street crossing to ensure a straight bicycle travel path across the intersection.

E. Pedestrian crossing island

1. The pedestrian crossing island is a space within the street buffer where pedestrians may wait between the street and the protected bike lane. Pedestrian crossing islands are specific to retrofit projects as reconstruction projects should elevate this area to sidewalk-level.
2. May be constructed of concrete or plastic delineators.
3. It should be a minimum of 6 ft. wide and should include detectable warning panels.
4. The pedestrian crosswalk should match the width of the crossing island openings.
5. A raised median may be employed to provide separation between the pedestrian crossing island and the bicycle queuing area.

F. Pedestrian and bicycle mixing zone

1. Pedestrian and bicycle mixing zones are areas where people walking are required to cross the bike lane before crossing the street. These mixing zones should be designed to indicate the preferred pedestrian crossing location across the bike lane and to communicate a clear message to bicyclists that pedestrians have the right-of-way.
2. Pedestrian crossings of the bike lane should be straight and align with crosswalk in the street.
3. Crosswalk pavement markings should extend across the bike lane at mixing zones.

G. Curb ramps

1. [Curb ramps](#) are required when transitioning pedestrians from the sidewalk to the street.
2. Detectable warning strip made of truncated domes must be provided at the edges of all pedestrian street crossings.

H. Maintenance

3. Protected intersection design must accommodate access to and maintenance of existing stormwater infrastructure and design should be coordinated with Surface Water and Sewers.
4. On-street bike lanes must maintain minimum bikeway widths and clearances at the intersection to accommodate routine maintenance and winter snow clearance/removal. See [delineator-protected bike lane guidance](#) for details.
5. Corner islands must maintain a minimum distance of 6' from any vertical obstructions or curb to accommodate routine maintenance and snow clearance/removal.

DESIGN CONSIDERATIONS FOR TWO-WAY BIKE LANES (FOR RETROFIT AND RECONSTRUCTION PROJECTS)

Two-way bike facilities are the most common protected bikeway facility type throughout Minneapolis. They typically require less width than paired one-way facilities and afford safe and comfortable experiences when designed to prioritize non-motorized users at intersections.

Since they are typically designed to carry two-way traffic on one side of the street, however, two-way protected bike lanes can introduce additional modal conflict points with turning vehicles at intersections. It is especially important to be conscious of any motor vehicle left turns across a two-way bike lane.

Safe and comfortable two-way bike facilities communicate clear right of way priority, predictable travel paths, and adequate sightlines. This is achieved through intersection design elements that reflect the traffic, operational, and land-use context in which they are being installed.

A. Raised crossing.	Raised crossings should generally be included in street reconstruction projects when a protected bike lane crosses an Urban Neighborhood street and should be considered when crossing a Parkway. This is especially important at crossings for two-way bike lanes.
B. Bicycle signal phasing	In locations with heavy motor vehicle turning movements, bicycle-specific signal phasing should be considered to reduce turning conflicts with motorized traffic. This includes Leading Bike Interval (LBI) & Lagging Left Turn phasing, Protected-Permissive Bike Signal phasing, and fully Protected Bike Signal phasing. Note that bicycle-specific signal phasing may be subject to the FHWA Request to Experiment (RTE) process. For additional detail on bicycle signal phasing, please reference the NACTO Don't-Give-Up-at-the-Intersection Design Manual pages 31-35.
C. Mitigating turning movement conflicts	To mitigate conflicts from left-turning vehicles across the bikeway, consider the following: <ol style="list-style-type: none"> 1. Install a TURNING VEHICLES YIELD TO BICYCLES AND PEDESTRIANS sign (R10-15 alt.); 2. Implement a protected left-turn phase for motorized traffic that does not conflict with the bicycle crossing movement; or 3. Restrict left turns.
D. Striping	Green conflict zone markings matching the width of the two-way bike lane may be striped through intersections with a solid single yellow centerline to indicate two-way traffic.
E. Mixing zones not allowed	A vehicular mixing zone is not appropriate for two-way protected bike lanes.
F. Motorized encroachment	Delineators may be installed in the center of the bike lane at vehicular access points to discourage motorized traffic from accidentally entering the bike lane.
G. Additional details	For additional guidance on design considerations for two-way bikeways at intersections, please reference the MassDOT Separated Bike Lane Planning & Design Guide pages 62 -67.

Figure 3.7E.4: Protected intersections for two-way bike lanes

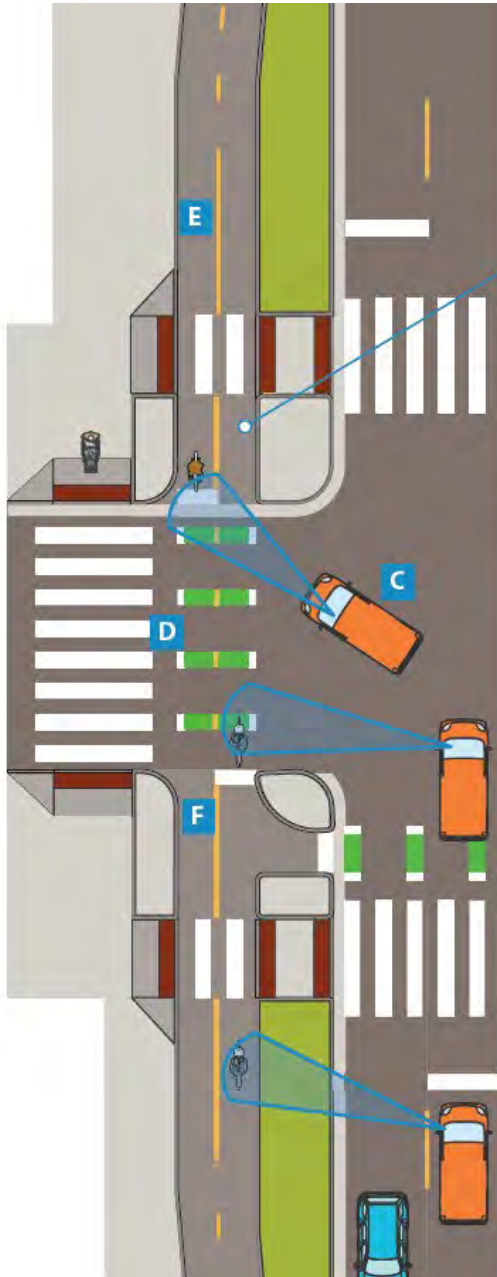

bend out and offset bikeway design improves sightlines and creates more space for vehicles to yield to bicyclists and pedestrians

Shared use paths require intersection designs that safely accommodate bi-directional bicycle traffic.



INTRODUCTION

Shared use paths require intersection designs that safely accommodate bi-directional bicycle traffic. Shared use paths with proper intersection designs are considered an All Ages and Abilities facility given their physical separation from motorized traffic and ability to appeal to a broad spectrum of people looking to travel by bike or micromobility.

Since shared use paths are usually designed to accommodate two-way travel and incorporate a buffer or boulevard space between the path and adjacent roadway, it is important to prioritize user safety and visibility at all conflict points with motorized traffic. The MnDOT Bicycle Facility Design Manual recommends the following to increase safety:

- Reduce conflict points;
- Reduce motor vehicle speeds at conflict points;
- Increase the predictability of path and roadway user behavior; and
- Increase the path separation from the roadway at conflict points.

Figure 3.7E.5: Shared use path crossings

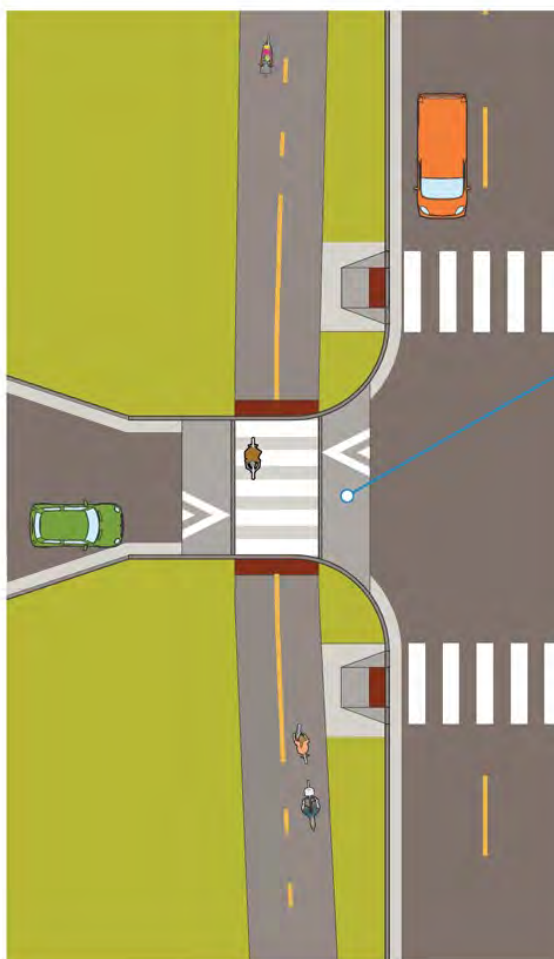

raised crossings should generally be included when a shared use path crosses an Urban Neighborhood street and should be considered when crossing a Parkway

DESIGN CONSIDERATIONS

A. APS push button placement	APS push-button placement at signalized intersections should be located outside of the travel path of bicycles and pedestrians while still maintaining required ADA spacing dimensions.
B. Striping	Shared use paths should be striped with block-style crosswalk markings that match the width of the path.
C. Detectable warnings	A detectable warning strip made of truncated domes should extend the full width of the shared use path at intersections.
D. Bend-out bikeway design	<ol style="list-style-type: none"> 1. At signalized intersections, consider shared use path geometry such as a bend-out trail design to improve sightlines and user orientation across an intersection (see protected intersection guidance for further details). 2. Bend-out designs should maintain a minimum offset distance of 6'.
E. Raised Crossings	Raised crossings should generally be included when a shared use path crosses an Urban Neighborhood street and should be considered when crossing a Parkway.
F. Access Management	Access management can be used to remove conflict points for all roadway users, including dead-ending intersecting streets where feasible.
G. Signal phasing/timing	At signalized intersections, consider making changes to signal timing to incorporate leading bicycle interval/leading pedestrian interval, or incorporate bike/pedestrian-only signal phases per MUTCD allowance.
H. Additional details	Please reference the MnDOT Bicycle Facility Design manual pages 5-13 to 5-20, and 5-27 to 5-30 for additional intersection design guidance.
I. Driveway crossings	<ol style="list-style-type: none"> 1. Elevation and cross slope. The width and grade (not greater than 2% cross slope) of the shared use path should generally continue across driveways and alleys whenever possible. 2. Pavement materials. Trail pavement materials should be continued across driveways to eliminate the need for horizontal expansion joints and provide additional visual delineation between the path and driveway surface. 3. Driveway Consolidation. Where there are multiple driveway entrances into a single destination, consider driveway consolidation to reduce conflict points. See driveways guidance for more details. 4. Striping. A white edge line may be striped at driveways to further visually delineate the trail crossing. 5. Bend-out bikeway design. At high-volume driveway entrances, consider shared use path geometry such as a “bend out” trail design and/or a raised crossing to improve sightlines and reduce motor vehicle speed. 6. Consider marked crosswalks. Consider including crosswalk striping across high-volume driveways.

3.7E Two-way bikeway transitions

Transitions between one-way and two-way bicycle facilities are a component of some bicycle projects and require careful consideration.

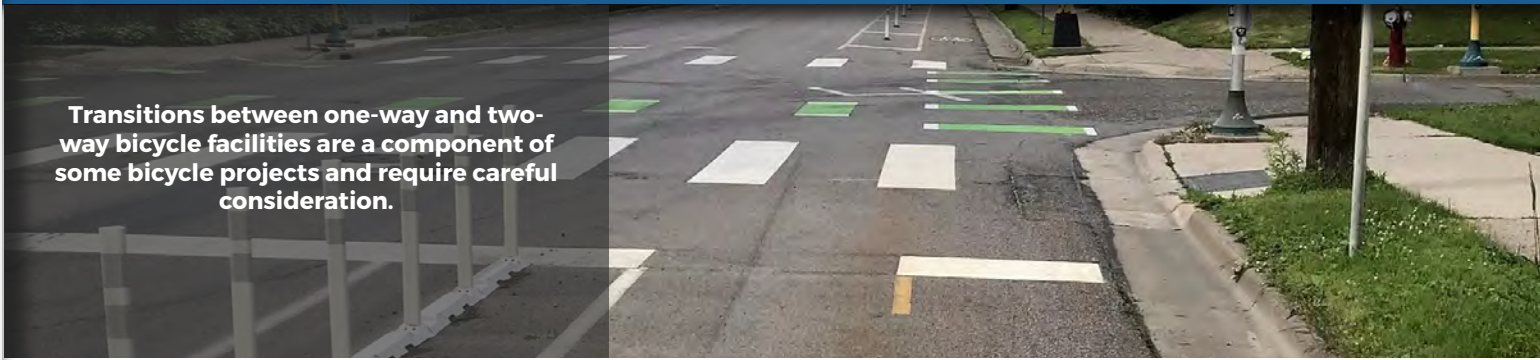

INTRODUCTION

Transitions between one-way and two-way bicycle facilities are a component of some bicycle projects and require careful consideration. Transitions between two-way and one-way bicycle facilities requires people biking contra-flow to traffic to cross the street. Transition design should reflect the unique context of the intersection where it is located and should reinforce a clear travel path across the intersection and clear right of way priority for users.

Figure 3.7E.6: Two-way bikeway transitions

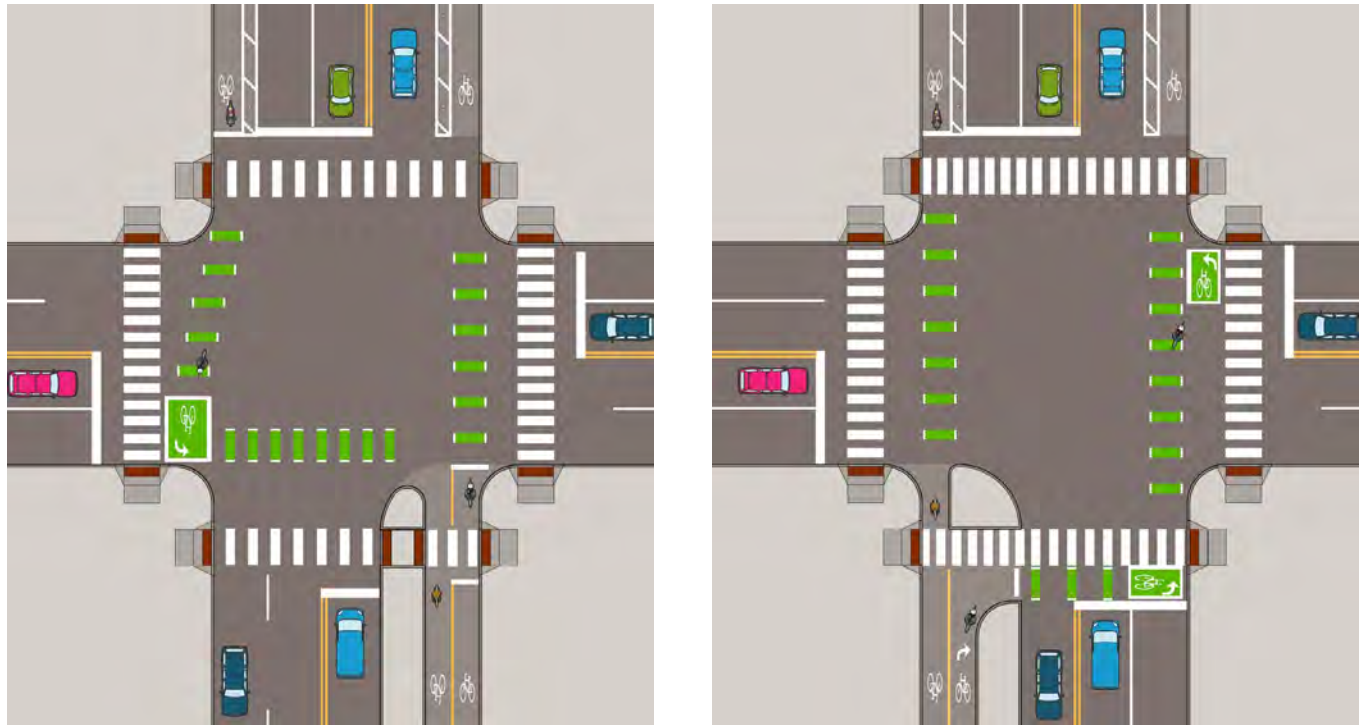

DESIGN CONSIDERATIONS

A. Striping	<ol style="list-style-type: none"> 1. Consider the use of green conflict zone markings, including solid green (non-dashed) markings to indicate the appropriate travel path for transitioning across the roadway. 2. Stop bars should be installed wherever bicycles transition across the roadway to prevent encroachment into the transition area.
B. Location	<p>Bicycle transitions across the roadway may be located on either side of the adjacent crosswalk.</p>
C. Signage	<p>"NO TURN ON RED" (R10-11) signage may be necessary at some or all legs where the bicycle transitions and two-stage turn boxes are located.</p>
D. Two-stage turn boxes	<p>Two-stage turn boxes (see figure 3.7E.6) may be employed to assist in transitioning across the roadway, especially at locations with high traffic volumes.</p>
E. Signal coordination	<p>At signalized intersections, the bicycle transition should be coordinated with the cross-street signal phase to cross the roadway.</p>
F. Signal heads and phasing	<p>Bicycle-specific signal heads and phasing may be installed to assist bicycles transitioning across the roadway.</p>

This guidance should be used for street retrofit bike lane projects where implementing protected intersections is not feasible and mixing zones are required.

INTRODUCTION

This guidance should be used for street retrofit bike lane projects where implementing protected intersections is not feasible and mixing zones are required. This guidance is not intended for use with street reconstruction projects.

BIKE LANE ADJACENT TO DEDICATED TURN LANES

At intersections with dedicated turn lanes, provide separate space for the bike lane and turn lane whenever feasible. At intersection approaches, drivers must yield to bikes in the mixing area to enter the turn lane.

Figure 3.7E.7: Bike lane adjacent to dedicated turn lane

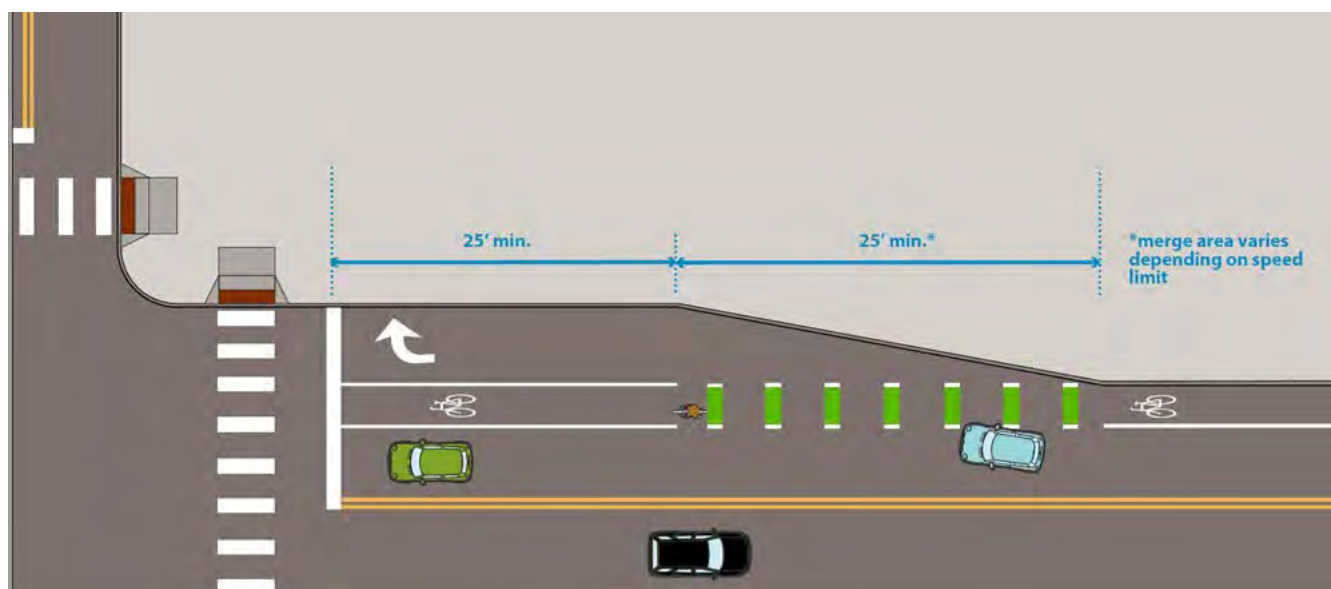

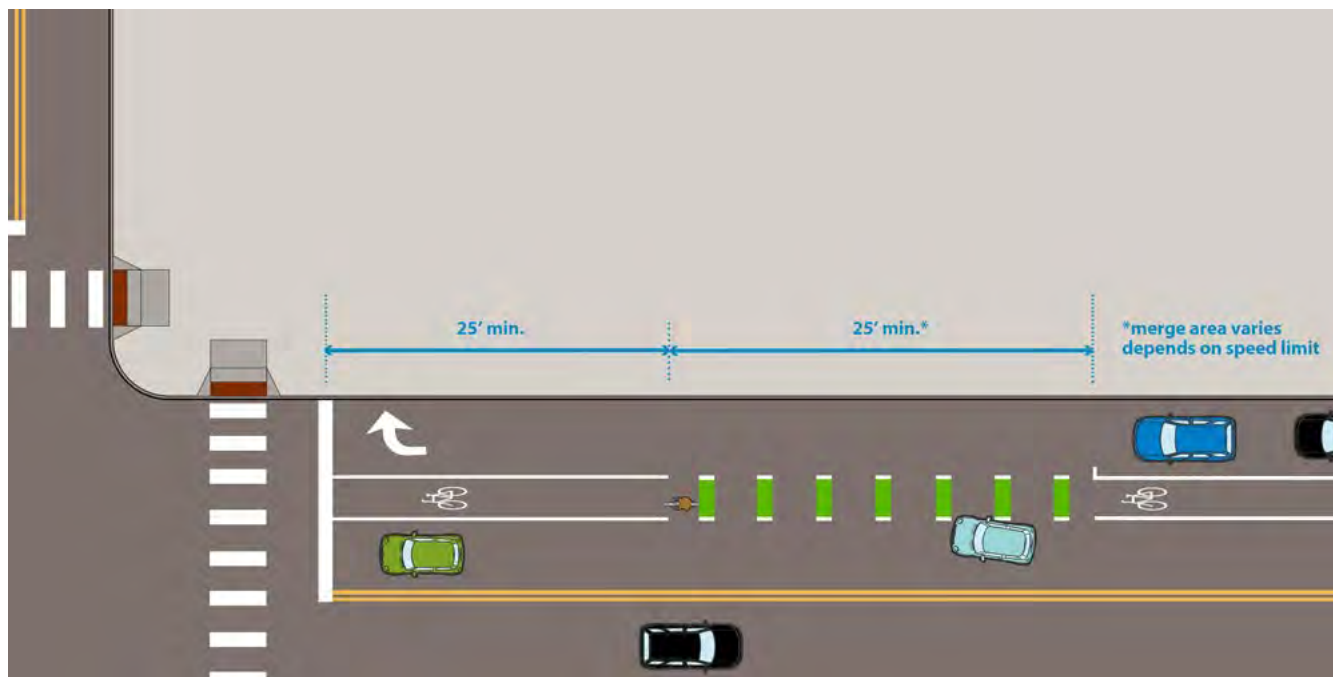

DESIGN CONSIDERATIONS

A. Bike lane location	<ol style="list-style-type: none"> 1. The bike lane should generally be located to the left of the right-turn lane, or to the right of the left-turn lane. 2. If a protected intersection is being implemented in coordination with an intersecting protected bikeway, the bike lane can be moved to the right of the right-turn lane.
B. Merging location	The merge location should be located a minimum 30 feet in advance of the intersection.
C. Mixing zone dimensions	Mixing zone length should be determined by the posted speed limit.
D. Signage	BEGIN RIGHT-TURN LANE YIELD TO BIKES (R4-4) should be installed at the beginning of mixing zones.
E. Striping	Green conflict zone markings are recommended for the mixing area to indicate the preferred bicycle travel path and to increase driver awareness.
F. Parking	Parking should be prohibited a minimum of 10' in advance of the beginning of the motor vehicle taper.

SHARED BICYCLE RIGHT-TURN LANE

In space-constrained locations with a dedicated right-turn or left-turn lane, bike lanes may share the turn lane space to continue through the intersection. Since shared lanes are not as comfortable as dedicated bike lanes, they should only be pursued with street retrofit projects where all other bike lane intersection design options are exhausted.

3.7E Bike lane retrofit projects with mixing zones

BIKE LANE AT INTERSECTIONS WITHOUT A TURN LANE

Most intersections throughout Minneapolis lack dedicated turn lanes. Bike Lane mixing zones are typically employed upstream of unprotected intersections to indicate where drivers should merge into the bike lane to complete a turn.

Design Considerations

A. Dimensions	Mixing zones are typically 60' in length and are striped upstream of intersections or in advance of transit stops.
B. Striping	<ol style="list-style-type: none"> Mixing zones may be striped with either dotted white lines or green conflict zone markings. Dotted white lines and green conflict zone markings shall be 2' in length with a 6' gap (8' cycle) (Minneapolis Pavement Marking Notes, Colored Conflict Zones Standard Plate) Dotted white lines or green conflict zone markings may be continued across the intersection to indicate the preferred bicycle travel path and increase driver awareness At intersections with one-way streets where turning movements are prohibited, continue solid bike lane striping to the intersection

ONE-WAY PROTECTED BIKE LANE WITH MIXING ZONE

Protected intersections are preferred but not always feasible with protected bike lane retrofit projects. As a result, protected bike lanes may be design with mixing zones when space constraints preclude protected intersections.

Figure 3.7E.9: Bike lane without turn lane

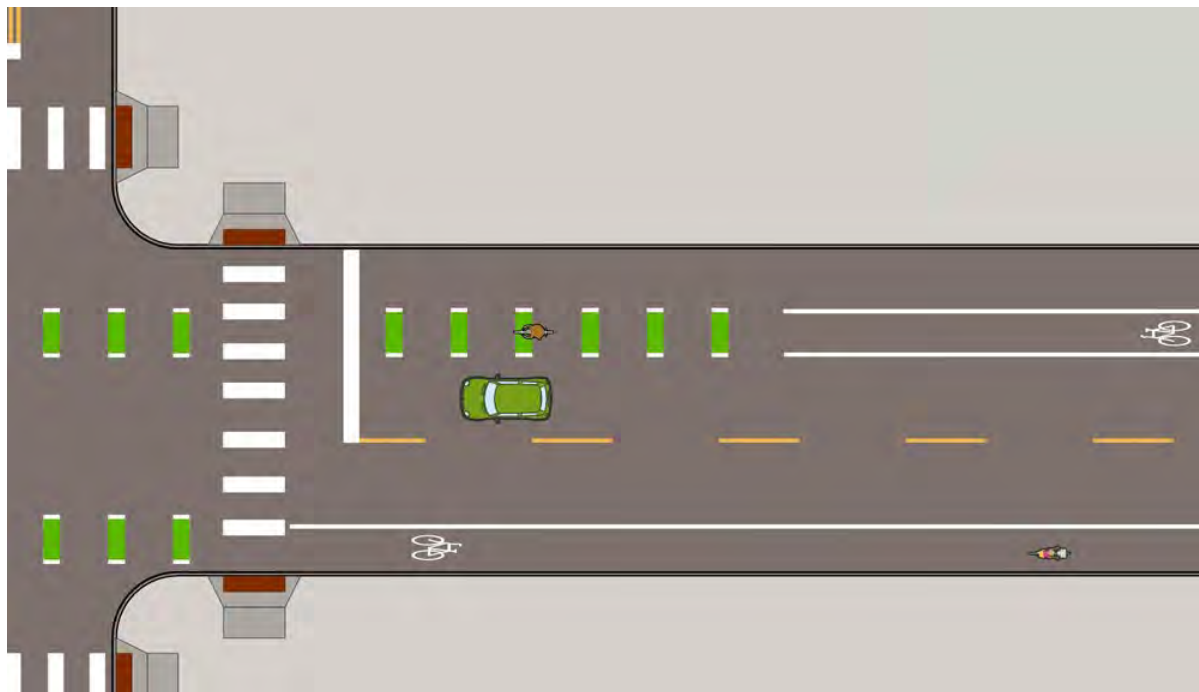
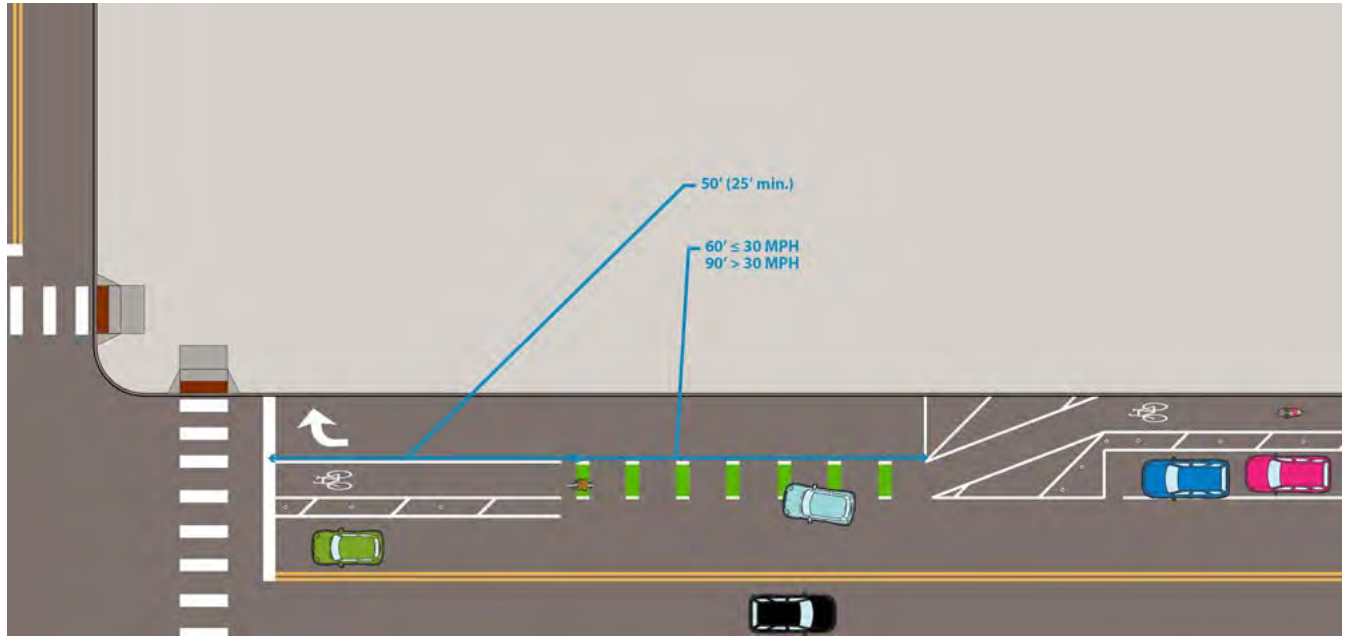

Figure 3.7E.10: One-way protected bike lane with mixing zone



Design Considerations

A. Mixing Zones

One-way protected bike lanes may incorporate mixing zones to accommodate dedicated right-turn lanes. Follow details in "Bike lanes adjacent to a dedicated turn lanes" guidance.

B. Vertical delineation

One-way on-street protected bike lanes should extend vertical delineation to the intersection whenever possible.

C. Bike lane taper

When transitioning the protected bikeway from adjacent to the curb to the left of a dedicated turn-lane, locating the bike lane taper in advance of the mixing zone is preferred.

3.7E Bike lanes at t-intersections

To reinforce parking prohibitions in intersections, consider providing either on-street or off-street separation for the bike lane through the top of the T-intersection.

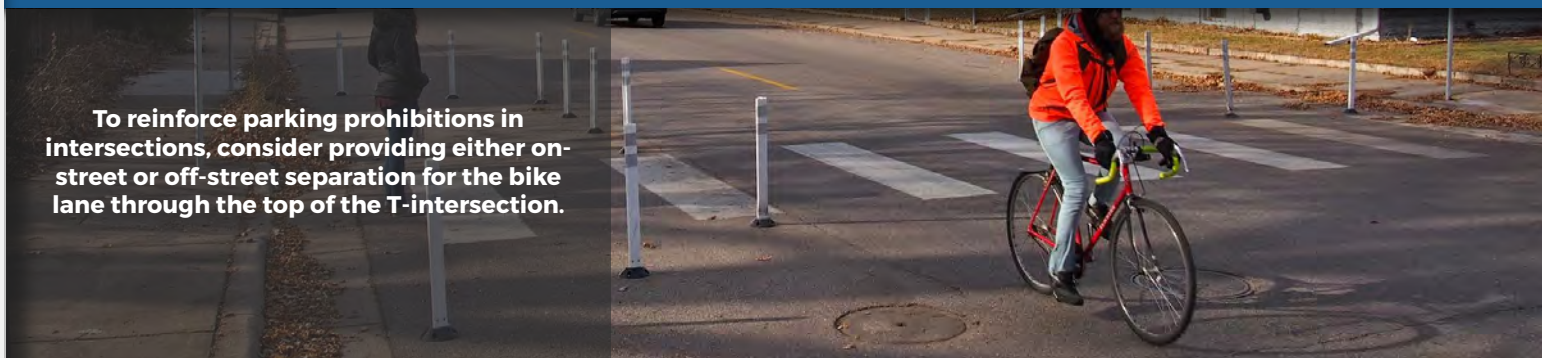

INTRODUCTION

To reinforce parking prohibitions in intersections, consider providing either on-street or off-street separation for the bike lane through the top of the T-intersection. Note that bikes must still yield to pedestrians crossing the bike lane.

Figure 3.7E.11: Bike lanes at t-intersections



DESIGN CONSIDERATIONS

A. Buffer

When adequate space is available, implement a buffer between the bike lane at the top of the T-intersection and the adjacent travel lane. Vertical delineation is preferred for on-street facilities.

B. Sidewalk-level bike facilities

When reconstructing a T-intersection or retrofitting the intersection with permanent materials, consider a sidewalk-level bike facility that continues through the top of the T-intersection. If this facility is intended as a shared use path, it should meet [shared use path](#) dimensions and standards.

C. On-street to off-street transitions

Sidewalk-level bicycle facilities should utilize bicycle slip ramps when transitioning to or from on-street bike lane.

3.7E Two-Stage Turn Queue Boxes

Two-stage turn queue boxes designates space for bicycles to wait for traffic to clear in an intersection while performing a two-stage turn across a street.

INTRODUCTION

Two-stage turn queue boxes designates space for bicycles to wait for traffic to clear in an intersection while performing a two-stage turn across a street. Two-stage turn queue boxes may be used for making left or right turns.

Figure 3.7E.12: Two-stage turn queue boxes

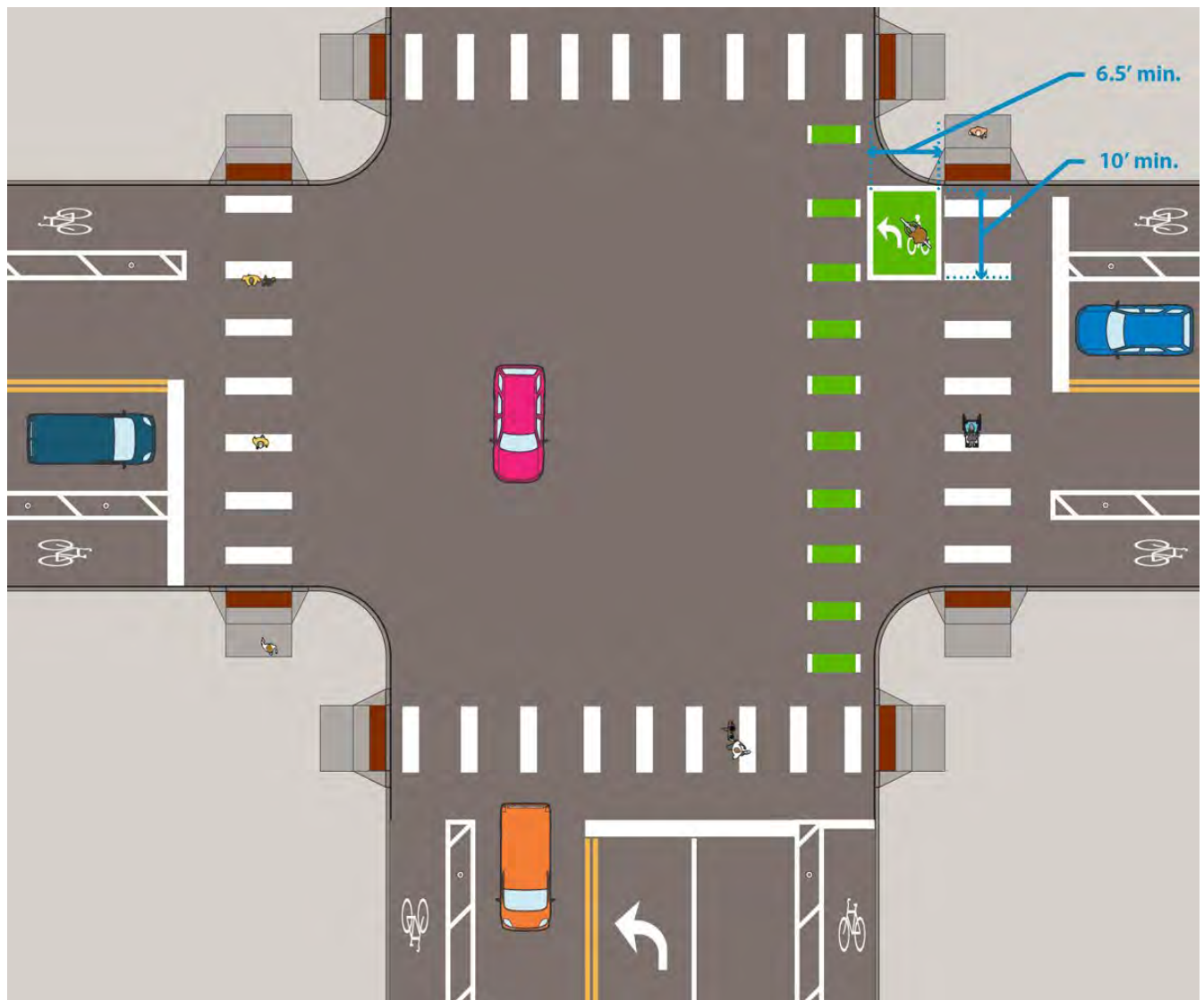

DESIGN CONSIDERATIONS

A. Location	<ol style="list-style-type: none"> 1. Two-stage turn queue boxes should be located outside the path of through and turning motorized traffic, and adjacent to the intended bicycle travel path through the intersection. When space is not available to accommodate this placement, turn boxes should not be installed. 2. Locate two-stage turn queue boxes on the intersection (downstream) side of the crosswalk to reduce conflicts with pedestrians.
B. Dimension	Two-stage turn queue boxes will vary in dimensions and placement depending on context. See Figure 3.7E.11 for more details.
C. Operations	<ol style="list-style-type: none"> 1. “No Turn on Red” (R10-11) restrictions should be used to prevent vehicles from entering the queuing area. 2. In most contexts, bicycles can still merge into vehicular travel lanes to make a one-stage turn if they chose to.
D. One-way to two-way transitions	Two-stage turn queue boxes may be used to assist transitions between one-way and two-way bike facilities and other complex movements.
E. MnDOT approval	If installing a two-stage bicycle turn box, provide the location to the MnDOT Traffic Standards Engineer at 651-234-7388 to adhere to the requirements of the FHWA statewide approval.

Bicycle boxes are primarily used to allow people biking to stop ahead of the traffic queue.

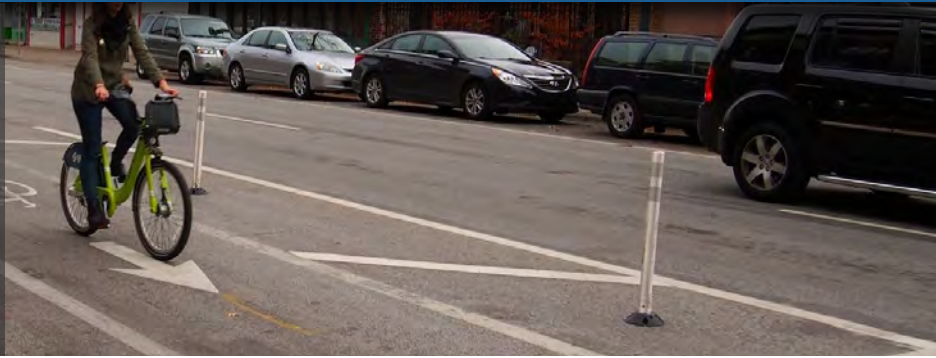

INTRODUCTION

Bicycle boxes are primarily used to allow people biking to stop ahead of the traffic queue to increase visibility and reduce conflicts at the beginning of the green signal phase. This is particularly helpful in reducing conflict points with right-turning drivers.

Figure 3.7E.13: Bicycle boxes

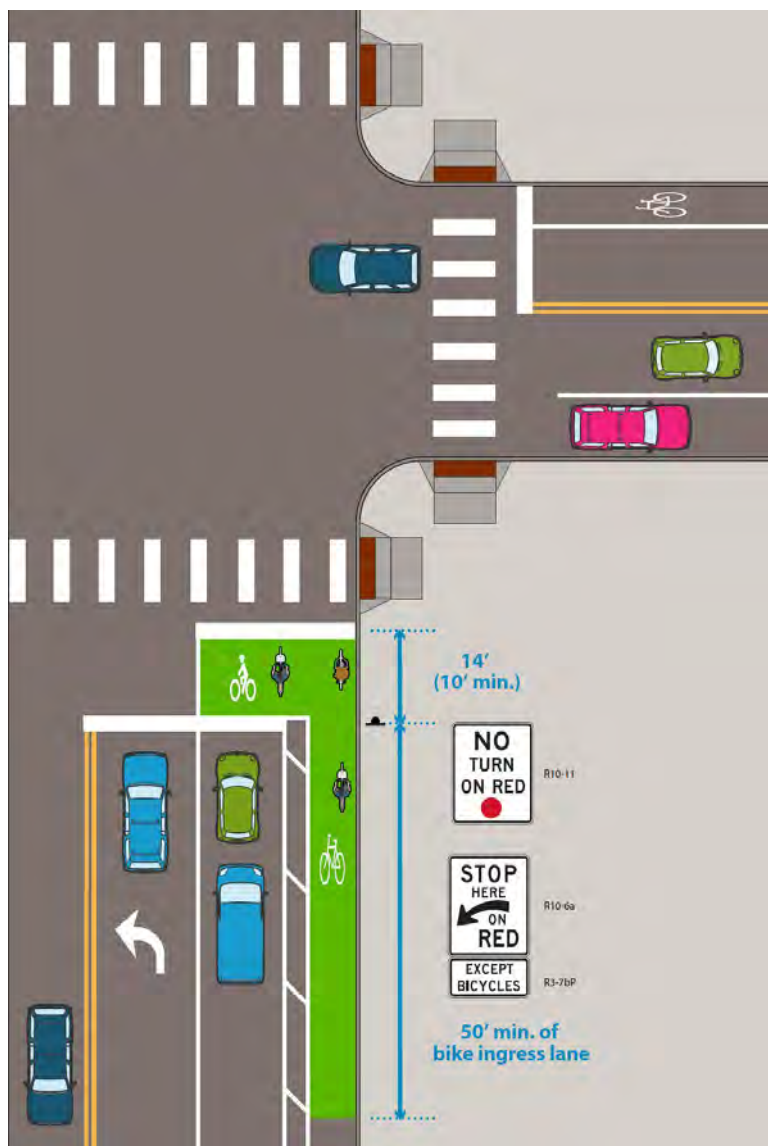

DESIGN CONSIDERATIONS

A. Location	Only install at signalized intersections.
B. Striping	Stripe with solid green pavement paint or durable pavement markings to improve visibility for drivers. See Figure 3.7E.12 for details. Bike box striping should typically extend across no more than one travel lane
C. Signage	“NO TURN ON RED” (R10-11) or “STOP HERE ON RED” (R10-6a) restrictions with and “EXCEPT BICYCLES” plaque (R3-7bP) should be used to prevent vehicles from entering the queuing area.

Employing passive bicycle detection at actuated traffic signals is an important component of a safe and comfortable bicycle network.

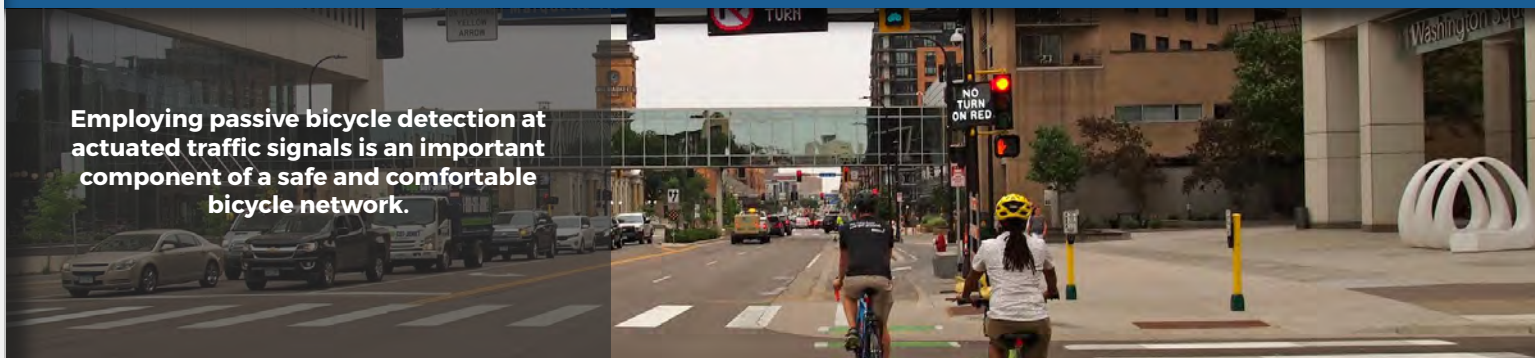

INTRODUCTION

Employing passive bicycle detection at actuated traffic signals is an important component of a safe and comfortable bicycle network and supports bicycling as a practical means of transportation

Figure 3.7E.14: Bicycle detection at signalized intersections

DESIGN CONSIDERATIONS



EXHIBIT 4-23: Bicycle Detection Pavement Marking Dimensions



EXHIBIT 4-24: R10-22 Sign

A. Actuated Signals

At actuated signals, passive detection is preferred whenever possible.

B. APS

Where accessible pedestrian signal push buttons are required, passive detection can still be implemented.

C. Detection Location

Passive detection should be located across the entire bicycle path, in any two-stage turn box or bike box, and adjacent to a curb (or other footrest) whenever possible.

D. Pavement Markings

When using inductive loop detection, the bicycle detector pavement marking can be used to identify the best place for a bicyclist to position their bike for detection, and can be supplemented with a Bicycle Signal Actuation sign (R10-22). See Figure 3.7E.13 for more details.

Traffic circles are an intersection control that can lower speeds and improve safety at the intersection of two Urban Neighborhood streets.

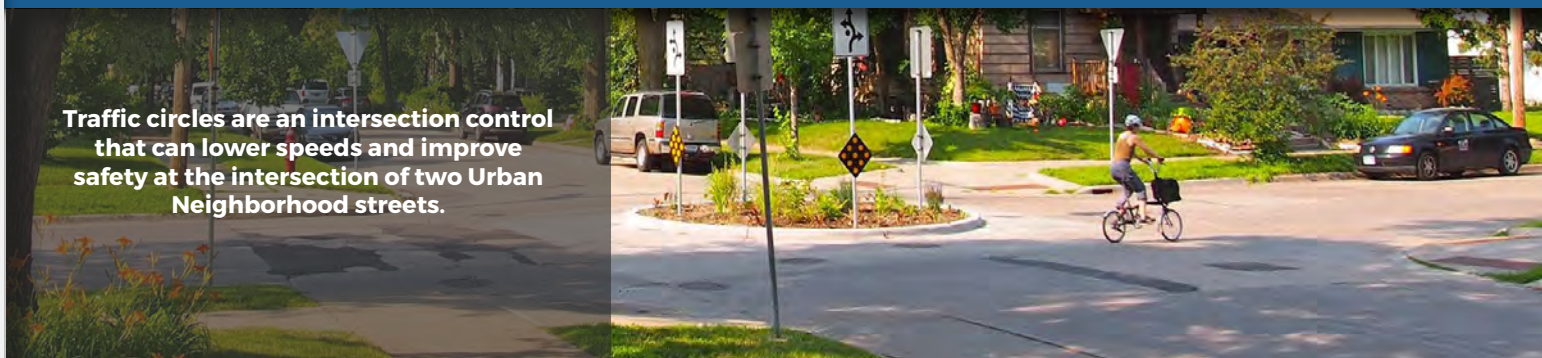

INTRODUCTION

Traffic circles are an intersection control that can lower speeds and improve safety at the intersection of two Urban Neighborhood streets. Given space constraints, traffic circles are generally not an option for other street types.

DESIGN CONSIDERATIONS

A. When to use

Traffic circles should be considered whenever there are intersecting Urban Neighborhood streets. They should be prioritized at intersecting Urban Neighborhood streets along [neighborhood greenways](#) or streets with documented speeding or crash challenges. Depending on the situation, it may be challenging to balance providing truck access with achieving traffic calming.

B. Dimensions

1. Traffic circles should be designed to accommodate appropriate [design and control vehicles](#) while keeping speeds as low as possible. The diameter of the traffic circle will vary depending on the context and turning movements will need to be run.
2. Designers should consider mountable curbs to handle larger vehicles while supporting low speeds.

C. Accessibility considerations

1. Traffic circles can present challenges for people with visual disabilities. Extra consideration should be made to ensure that pedestrians are visible to drivers.
2. Detectable warning surfaces made of truncated domes must be installed on the curb ramps to alert users that they are about to enter the roadway and directional curb ramps are recommended. See [MnDOT's current curb ramp guidelines](#), [curb ramp standard plans](#), and [other design guidance and standards](#) for details on constructing detectable warnings.
3. Designers can also consider installing marked crosswalks to future highlight where pedestrians will be crossing.

D. Signage

1. YIELD (R1-2) signs are used on the intersecting streets rather than stop signs.
2. A intersection lane control sign with fish-hook arrows is used on the traffic circle (see Figure 3.7F.1).

Figure 3.7F.1: Traffic circle signage

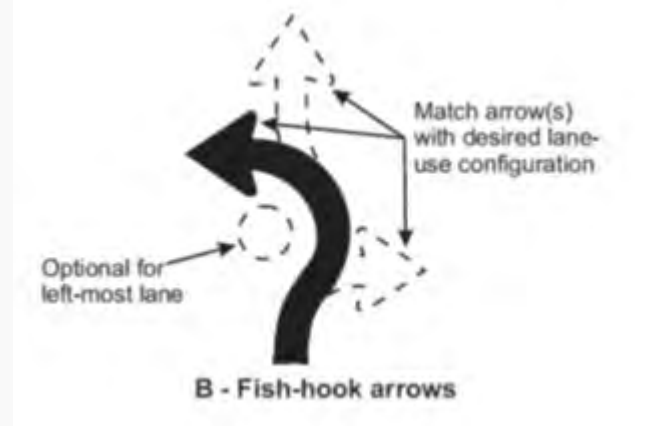
**E. Greening**

1. Designers should generally work to include greening in traffic circles whenever feasible.
2. Plantings need to be less than 3' tall to maintain good visibility.
3. Maintenance of greening needs to be coordinated ahead of time.
4. There are unique considerations for placing green stormwater infrastructure in a median, including details on inlets and maintenance access. Coordinate with Surface Water and Sewers.
5. See [greening guidance](#) and [green stormwater infrastructure guidance](#) for more details.

F. Delineator traffic circles

Low-cost traffic circles can be implemented using delineators in street retrofit projects (see Figure 3.7F.2).

Figure 3.7F.2: Delineator traffic circle

